

# THE INDIAN JOURNAL OF TECHNICAL EDUCATION

Published by  
**INDIAN SOCIETY FOR TECHNICAL EDUCATION**  
Near Katwaria Sarai, Shaheed Jeet Singh Marg,  
New Delhi - 110 016



# INDIAN JOURNAL OF TECHNICAL EDUCATION

Volume 47 • Special Issue • No. 2 • January 2024

## Indexed in the UGC-Care Journal list

### Editorial Advisory Committee

**Prof. Pratapsinh K. Desai** - Chairman  
President, ISTE

**Prof. N. R. Shetty**  
Former President, ISTE, New Delhi

**Prof. (Dr.) Buta Singh Sidhu**  
Vice Chancellor, Maharaja Ranjit Singh  
Punjab Technical University, Bathinda

**Prof. G. Ranga Janardhana**  
Vice Chancellor  
JNTU Anantapur, Ananthapuramu

**Prof. D. N. Reddy**  
Former Chairman  
Recruitment & Assessment Centre  
DRDO, Ministry of Defence, Govt. of India  
New Delhi

**Prof G. D. Yadav**  
Vice Chancellor  
Institute of Chemical Technology, Mumbai

**Dr. Akshai Aggarwal**  
Former Vice Chancellor  
Gujarat Technological University,  
Gandhinagar

**Prof. M. S. Palanichamy**  
Former Vice Chancellor  
Tamil Nadu Open University, Chennai

**Dr. D. B. Shinde**  
Vice Chancellor  
Shivaji University  
Kolhapur

### Editorial Board

**Dr. Vivek B. Kamat**  
Director of Technical Education  
Government of Goa, Goa

**Dr. E. B. Perumal Pillai**  
Director-HRDC & Professor of Civil Engg.  
Vel Tech. University, Chennai

**Prof. C. C. Handa**  
Professor & Head, Dept. of Mech.Engg.  
KDK College of Engineering  
Nagpur

**Prof. S. Mohan**  
Chief Executive, Innovation Centre (SID)  
Indian Institute of Science, Bangalore

**Prof. Y. Vrushabhendrapa**  
Director  
Bapuji Institute of Engg. & Technology,  
Davangere

**Dr. Anant I Dhattrak**  
Associate Professor, Civil Engineering  
Department, Government College of  
Engineering, Amravati, Maharashtra

**Dr. Jyoti Sekhar Banerjee**  
Associate Editor

**Dr. Rajeshree D. Raut**  
Associate Editor

**Dr. Y. R. M. Rao**  
Editor

*Copyright (c) Indian Society for Technical Education, The Journal articles or any part of it may not be reproduced in any form without the written permission of the Publisher.*

# INDIAN JOURNAL OF TECHNICAL EDUCATION

---

Published by  
INDIAN SOCIETY FOR TECHNICAL EDUCATION  
Near Katwaria Sarai, Shaheed Jeet Singh Marg  
New Delhi - 110 016





---

## Editorial

---

The dawn of the Fifth Industrial Revolution (5IR) signifies a paradigm shift from the preceding Fourth Industrial Revolution (4IR), marking a transition from a competitive approach between humans and machines to a collaborative one with a special focus on the well-being of multiple stakeholders. In this era, the focus has expanded beyond technological progress for profits to encompass the well-being of all of humanity and the planet. This concept note explores the implications of the 5IR, particularly in retail and service settings, and proposes the institutionalization of Sustainable Development Goals (SDGs) within the educational system as a strategic response.

5IR prioritizes understanding and maximizing the strengths of both humans and technology. This collaboration is metaphorically described as humans and machines “dancing together,” highlighting the need for a cooperative rather than competitive relationship. Integrating SDGs into the educational system aligns with the principles of the 5IR, preparing future generations to navigate the complexities of human-technology collaboration responsibly. As we stand at the intersection of technological innovation and sustainable development, instituting SDGs in education becomes a cornerstone for a resilient and harmonious future. Educational institutions can play a pivotal role in nurturing a generation of individuals equipped to address global challenges through collaborative and sustainable approaches.

The world faces unprecedented challenges, from climate change and resource depletion to social inequality and poverty. To address these issues, the United Nations has established the Sustainable Development Goals (SDGs), a roadmap for a more sustainable future. Engineering plays a crucial role in achieving these goals, and ensuring engineers are equipped with the necessary knowledge and skills is vital.

A global accreditation organization like ABET (Accreditation Board for Engineering and Technology) ensuring that engineering programs meet the standards necessary to prepare graduates for their successful careers. India’s accreditation bodies, like the National Board of Accreditation (NBA) and the National Assessment and Accreditation Council (NAAC) have reoriented their accreditation evaluation processes to ensure engineering graduates are well-equipped to contribute to achieving the SDGs.

This shift in engineering education is a positive step towards a future where the engineers are not only technically sound, but also equipped to address the world’s most pressing challenges. By integrating sustainability principles into their education, engineers can become powerful agents of positive change, creating a better future for all.

**New Delhi**

**Editor**

**31<sup>st</sup> January 2024**



**D. Y. Patil College of Engineering**  
Salokhenagar, Kolhapur  
Affiliated to Shivaji University, Kolhapur



## Editorial Board

### Patrons

**Prof. ( Dr.) D.T. Shirke**

Hon'ble Vice-Chancellor, Shivaji University

**Prof.( Dr.) P. S. Patil**

Hon'ble Pro-Vice Chancellor, Shivaji University

**Prof. (Dr.) S. H. Thakar**

Ag. Dean, Faculty of Science & Technology,  
Shivaji University

**Prof. (Dr.) M. S. Deshmukh**

Dean, Faculty of Humanities,  
Shivaji University

**(Dr.) Ajitsinh Jadhav**

Director, Board of Examinations & Evaluations,  
Shivaji University

**Dr Sangeeta Pant**

Invite

**Dr. Sanjay D. Patil**

Hon'ble Chancellor, DYP Agriculture & Technical  
University, Kolhapur

**Prof. (Dr.) S. S. Mahajan**

Dean, Faculty of Commerce & Management,  
Shivaji University

**(Dr.) M. V. Gulavani**

Ag. Dean, Faculty of Interdisciplinary Studies,  
Shivaji University

**(Dr.) V. N. Shinde**

Registrar, Shivaji University

**Smt. S. S Patil**

Finance & Accounts Officer, Shivaji University

### Seminar Convener

**Prof. (Dr.) M. S. Deshmukh**

Director, IQAC

**Dr A K Gupta**

Executive Director, DYP Group, Kolhapur (MS)

**Dr. Pratibha S. Patankar**

Professor & Head, Department of Education

**Dr Suresh D. Mane**

Principal, Dr DYP Pratisthans College of  
Engineering, SN, Kolhapur (MS)

### Seminar Director

**Dr. Vidyanand S. Khandagale**

Department of Education

### Coordinators

**Dr. Shivaleela Arlimatti**, HoD, CSE Department, DYPSN, Kolhapur

**Dr Uttam Satpute**, Dean Academics, DYPSN, Kolhapur

**Dr. (Smt.) Rupali Sankpal**

---

---

# Contents

1.	<b>Importance of Integrating SDGs into Educational System</b>	1
	Ranjita Ramesh Kalebere, Sopan Govind Khade	
2.	<b>The Transformative Role of Educational Institutions in Shaping Responsible Global Citizens</b>	6
	Vijay Sadashiv Sutar, R. B. Vhanabatte	
3.	<b>Exploring Digital Communication usage of Learning Management System (LMS) Software Between Lecturer and Students in Telkom University, Indonesia</b>	11
	Lucy Pujasari Supratman, Aep Wahyudin, Nagina Mali	
4.	<b>Rain Water Harvesting</b>	17
	S. S. Nale, A. D. Patil, R. V. Jadhav	
5.	<b>Institutionalization of Sustainable Development Goals in Educational System: Navigating the Fifth Industrial Age Science Teaching for achieving Sustainable Development Goals</b>	22
	Vidya Shivaji Suryawanshi, Nandkumar Dhondiram Dhanawade	
6.	<b>IoT in Education: Enhancing Learning Experience, Efficiency and Safety</b>	25
	Shailja Sanjay Panhalkar, Vanashri S. Shinde, Rucha A. Gurav	
7.	<b>Achieving Sustainable Development Goal 4 (SDG-4) through the Incorporation of ICT in the Teaching-learning Process</b>	30
	Sonali Bindhani, Geetha Gopinath	
8.	<b>Exploring the Transformative Terrain of the Fifth Industrial Revolution: Shifting Paradigms</b>	36
	Shivani Kale, Vidya. N. Abdulpur, Shrikant D. Bhopale, Abhijeet Mane	
9.	<b>A Study on Promoting Innovative and Creative Thinking via Collaborative Learning Strategies</b>	40
	Ashok Ramkrishna Tawar, G. S. Kamle	
10.	<b>Enhancing Higher Education: A Comprehensive Review of Outcome-Based Education Methodology and Course Outcomes Attainment in Pursuit of UN SDG No. 4</b>	45
	Suresh D. Mane, Ganesh Rathod, Shivaleela Arlimatti	
11.	<b>Best Practices for Educational Sustainable Development</b>	56
	Sanjana Sanjay Bhalkar, Pratibha Sadashiv Desai	
12.	<b>Educational Leadership in 5 IR : Nurturing Sustainable Innovators</b>	60
	Shivaji Govind Sawant, R. K. Shelake	
13.	<b>Tech-Driven Education: Understanding the Impact of 4IR and the Prospects for 5IR Integration with a focus on SDGs</b>	63
	Mercy Fernandez, Pratibha Patankar	
14.	<b>Exploring the Collaborative Dynamics between Humans and Technology in the 5IR</b>	68
	Vidya N. A., Shivani Kale	
15.	<b>Implications of Shifting from Competitive to Cooperative Paradigms in Educational Restructuring: A Comprehensive Research Analysis</b>	71
	Shrikant Bhopale, Shivani Kale, Rohit Raut, Rajesh Gade	
16.	<b>Educational Leadership in the 5IR: Nurturing Sustainable Innovators</b>	75
	Nirmale Rekha Laxman	

<b>17. Rankala Lake Water Pollution Physico-chemical Analysis and Remedies</b>	<b>82</b>
Monica Shinde, Harshada Vibhute	
<b>18. Predictive Mechanism for fault-detection in Electric Vehicles: A Sustainable Transport</b>	<b>86</b>
Uttam S Satpute, Suresh D. Mane, S. S. Deshpande	
<b>19. Achievement of Sustainable Development Goals and Fifth Industrial Revolution Among the School Teachers: A Study</b>	<b>92</b>
Ranjit Hanmantarao Desai, Yuvraj Yashwant Pawar	
<b>20. Creative Metrics for Evaluating the Avoidance of Ill-beings &amp; Promotion of Well-beings</b>	<b>97</b>
Amey V. Diwan, Vinayak V. Diwan	
<b>21. Collaborative Strategies for 5th Industrial Revolution</b>	<b>101</b>
Minal Vijay Patil, P. B. Darade	
<b>22. Performance Analysis of Regenerative Braking of BLDC Motor using PID Controller</b>	<b>104</b>
Awadhut B. Chougale, Aniket A. Prabhavalikar	
<b>23. Professional Commitment and Spiritual Intelligence of Teachers on the Basis of Age: A Study at the Schools of Kullu and Mandi Districts of Himachal Pradesh</b>	<b>111</b>
Jyotika Guleria, Sangeeta Pant, Parul Sood, Vani	
<b>24. Integration of Sustainable Tourism Centered Curriculum at High School Level in Goa</b>	<b>119</b>
Pranjali .U. Dhargalkar	
<b>25. Rethinking Education through an Outcome-Based Education: A Case Study</b>	<b>124</b>
Pruthviraj Chavan, Akash Sakhare, Suresh Mane, Shivaleela Arlimatti, Ganesh Rathod	
<b>26. Online Academic and Administrative Audit: Score Card for Educational Institutions</b>	<b>128</b>
Chetna Pralhad Sonkamble, Rupali Ganpatrao Bharmal	
<b>27. A Study on Perception of Student-Teachers on Integration of Artificial Intelligence in B.Ed. Course</b>	<b>133</b>
M. R. Patil, S. S. Kumbhar	
<b>28. Integrating 5IR Principles in the Curriculum to Empower Future Generation Citizens: Opportunities and Challenges</b>	<b>138</b>
Jyoti Vasavada Pratiksha Modi	
<b>29. Preparing Students for the Fifth Industrial Revaluation and Role of Educational Institutes for It</b>	<b>145</b>
Ankush Ramchandra Bansode, Shashikant Shridhar Annadate	
<b>30. Fostering Sustainable Education with Artificial Intelligence in the Era of Industry 5.0</b>	<b>149</b>
Urmila R. Pol, Tejashree T. Moharekar, Parashuram S. Vadar	
<b>31. Critical Analysis of 5IR Skills Reflected in Syllabus of B.Ed-M.Ed (Integrated) Programme of Shivaji University, Kolhapur</b>	<b>155</b>
Saraswati A. Kamble, Anija A. Suryavanshi	
<b>32. Fostering Sustainable Development Competencies: A Study on Awareness Among D.Ed Students</b>	<b>161</b>
Sangeeta K. Chandanwale, Vidyanand S. Khandagale	
<b>33. Nurturing Sustainability: Unveiling UN's Sustainable Development Goals in Educational Practices at Shivaji University - A Case Study</b>	<b>167</b>
Seema R. Pal, Vidyanand S. Khandagale	



<b>34. A Comparative Study of Activity Based Learning (ABL) and Traditional Teaching Method</b>	<b>173</b>
Devdas Appasaheb Kare, Keshav Rambhao More	
<b>35. Paradigm Shift in the Role of Teacher as a Leader</b>	<b>176</b>
Sarika. S. Patil, Pratibha S Patankar	
<b>36. The Effectiveness of Counseling about Water Literacy on the Students in Class 10<sup>th</sup> from Ratnagiri Tehsil</b>	<b>180</b>
Sarjerao Pandurang Chavan	
<b>37. A Comparative Study of Fourth Industrial Revolution and Fifth Industrial Revolution: Educational Perspective</b>	<b>183</b>
Geetanali Joshi , P. S. Patankar	
<b>38. Importance of Integrating SDGs Into the Educational System</b>	<b>188</b>
Khandekar Kadambari Ramesh	
<b>39. A Study in the Development of An Eco-friendly Action Program for Language Creativity</b>	<b>191</b>
Keshav Rambhau More, Pranita Chandrashekar Teli	
<b>40. Beyond Profit : The Well-being Agenda of the 5IR</b>	<b>194</b>
Mamata Mukund Ghotal, Sarjerao P. Chavan	
<b>41. The Role of Challenges in the Study of Upper Primary Level Students</b>	<b>198</b>
Sarjerao Krishnat Sutar, R. V. Vanbatte	
<b>42. Enhancing Education Quality through Automated Assessment and Personalized Learning : Tool for Attainment of Sustainable Development Goal No. 4</b>	<b>203</b>
Ganesh Rathod, Suresh Mane, Shivaleela Arlimatti	
<b>43. Enhancing Higher Education: A Comprehensive Review of Outcome-Based Education Methodology and Course Outcomes Attainment in Pursuit of UN SDG No. 4</b>	<b>210</b>
Suresh Mane, Ganesh Rathod, Shivaleela Arlimatti	
<b>44. Empowering the Slow Learners to Enhance basic Concepts of Mathematics for Quality Education According to Sustainable Development Goal 4</b>	<b>221</b>
Ranitai Sachin Patil, Vidyanand Sambhaji Khandagale	
<b>45. Harnessing Educational Technology Leadership for the 5<sup>th</sup> Industrial Revolution in Teacher Education Using the Kouzes and Posner's Model</b>	<b>226</b>
Queen Hlakanyane, Pratibha. S. Patankar	
<b>46. Curriculum Mapping for Quality Education</b>	<b>231</b>
Sangita Sanjay Shinde, Pratibha S. Patankar	
<b>47. Sustainable Development Goals Reflected in Secondary School Textbook Content: A Qualitative Analysis Based on Bloom's Taxonomy</b>	<b>236</b>
Prachi Patil, Vidyanand Khandagale	
<b>48. Global Challenges, Local Solutions: SDGs in Diverse Educational Contexts</b>	<b>241</b>
Nigar K. Mujawar, Vidyanand S. Khandagale, Rekha L. Nirmale	
<b>49. Bridging the Academic Divide, Integrating Literacy and Numeracy Applications for Primary Students to Propel the Fifth Industrial Revolution</b>	<b>248</b>
Geeta Sugandh Ghatage, Rupali Uttam Sankpal	

<b>50. Contribution of the Fifth Industrial Revolution to the Achievement of the Sustainable Development Goals</b>	<b>257</b>
Yogesh Khanderao Patil	
<b>51. Entrepreneurship Skills in School Students of Goa -A Study</b>	<b>260</b>
Khushali U. Prabhu, Asawari Ashtekar, Renuka A. Pardesi, Siena Fernandes	
<b>52. Case Study of Goa Vidyaprasarak Mandal, Ponda Goa</b>	<b>265</b>
Uma Patil	
<b>53. A Project on Green Campus : Waste Water Management</b>	<b>271</b>
Amar D. Patil, Rutikesh P. Gurav	
<b>54. Achieving Social Inclusion in India: A Conceptual Framework towards Sustainable Development Goals (SDGs)</b>	<b>275</b>
Avinash Bhale, Jayanand S. Khandagale	
<b>55. Assessing Progress towards Sustainable Development Goals with Reference to India: A Comprehensive Analysis of the UN's 2030 Agenda</b>	<b>281</b>
Vitthal Thabbe, Vidyanand Khandagale	
<b>56. Role of Faculties in Achieving Excellence in Higher Education</b>	<b>291</b>
Suresh D Mane	
<b>57. Fostering Global Development: A Framework for Institutes to Contribute to SDGs 1, 5, and 8 through the Garment Manufacturing Training Center</b>	<b>297</b>
Ganesh Rathod, Abhijeet Mane, Suresh Mane	
<b>58. Life Guardian : Leveraging Node.js &amp; Socket.IO for Real-Time Emergency Response and Coordination in Crisis Situations</b>	<b>306</b>
Pratik Patil, Tejas Nikam, Pruthviraj Haladkar, Aditya Chende, Ganesh Rathod	
<b>59. Travel Advisor Using Web Technology</b>	<b>315</b>
Nilesh Hupare, Prasad Magar, Mahesh Mohite, Afrid Pathan, Ganesh Rathod	
<b>60. Articulation of Artificial Intelligence in Judiciary System: Navigating Fifth Industrial Age</b>	<b>321</b>
Utkarsh Subhashchandra Patankar, M. C. Sheikh	
<b>61. Digital Disruption: Transformative Trends and Impacts on Industry</b>	<b>327</b>
Suresh D. Mane, Shivaleela Arlimatti, Ganesh Rathod	
<b>62. Advancing Education for Achieving Sustainable Development Goals (SDGs)</b>	<b>334</b>
Shivani Kale, Vidya. N. Abdulpur, Preeti BhosaleSuresh Mane	
<b>63. Reflection of Sustainable Development Goals (SDGs) in the Teacher Education Curriculums</b>	<b>338</b>
Supriya K. Patil, Nagina S. Mali, P. S. Patankar	
<b>64. E- Content for Quality Education</b>	<b>344</b>
Afsana Harun Maneri, Paratibha S. Patankar	
<b>65. Restructuring the Syllabus with the help of Fifth Industrial Revolution through the Holistic Education</b>	<b>351</b>
Seema L. Kadam, Pratibha S. Patankar	

# Importance of Integrating SDGs into Educational System

**Ranjita Ramesh Kalebere**

Ph.D. Student

Department of Education

Shivaji University

Kolhapur, Maharashtra

✉ kranjita1445@gmail.com

**Sopan Govind Khade**

✉ drsgkhade@gmail.com

## ABSTRACT

Sustainable development goals (SDGs) are global goals set by The United Nations set for all the countries. There are 17 world development goals created in 2015 with the aim of “peace and prosperity for people and the planet, now and into the future.” The SDGs focus on the interconnected environmental, social and economic aspects of sustainable development by putting sustainability at their center. Education is the key component of sustainable development goals and also key factor for achieving them which requires provision of quality education for all. SDGs have a great influence upon the scenario of Indian Education. SDGs are serving as corner stone in reducing inequalities by providing all communities with access to quality education. Education for Sustainable Development means including key sustainable development issues into actual teaching and learning process. Curriculum development is the key factor for the acknowledgement of SDGs and bringing all the goals into actual practice. Integration of the SDGs into curriculum design, can enhance the learners' global citizenship competencies and can prepare them for the challenges and opportunities of the 21st century. It can also inspire them to take action and make worthy contribution to the sustainable development in their own communities. For integrating SDGs in education various curricular, co-curricular and extra-curricular activities can be organized at various levels of education right from primary to higher level of education taking into consideration the age and interest of students.

**KEYWORDS** : *SDGs- Sustainable Development Goals.*

## INTRODUCTION

The Sustainable Development Goals are a set of global targets aimed at promoting sustainable development and eradicating poverty, hunger, and inequality by 2030. Education is a key component of the SDGs, and achieving the SDGs requires the provision of quality education for all. Education is a key component of the SDGs, and achieving the SDGs requires the provision of quality education for all peace and non-violence. SDGs adopted in 2015 are inclusive of many of the goals that were set in the year 2000, focusing on health, education, gender equality, environmental stability, etc.

Education works at various levels like creating awareness among people, empowering people, enhancing the quality of living and many more things but it is necessary that education must be available and accessible to all and it must enable the people to live

with honor and dignity. By achieving educational SDGs it is very possible to achieve all other SDGs all over the world as education is the key factor to achieve all the sustainable development goals. By integrating SDGs into educational system it is possible that all SDGs can be achieved at rapid pace and can be beneficial to a wide population all over the world.

## SDGS

SDGs are a group of 17 worldwide objectives which will be achieved by 2030. The SDGs, also known as the Global Goals, SDGs address a variety of social, economic, and environmental issues, such as poverty, hunger, health, education, gender equality, clean water and sanitation, affordable and clean energy, and economic growth, innovation and infrastructure, reduced inequalities, sustainable cities and communities, responsible consumption and production,

climate action, life below the waterline, life on land, peace, justice etc. All SDGs are stated in such a way that action in one area will affect outcomes in others areas, and the progress must balance social, economic and environmental sustainability.

### IMPORTANCE OF SDGS

All the SDGs will be accomplished by the year 2030. Its agenda is very clear which moves towards the sustainable development of the planet and its each and every sector. Approaches regarding to sustainable development should be balanced and integrated to the social, environmental and economic dimensions, also looking at governance, and interconnect the various areas. The beauty of the goals is that everyone can contribute, and every contribution, small or big, will make a big impact on our world. The theory underlies each of those goals from eliminating hunger to reducing inequalities to building sustainable communities around the world.

In India, SDGs have been accepted as a roadmap for achieving inclusive and sustainable development. The country has made significant progress in various areas related with the SDGs. Efforts to reduce poverty have resulted in a decline in the poverty rate, lifting millions of people out of poverty.

India has made tremendous efforts in improving access to education, achieving universal primary school enrolment and retention rate. Maternal and child health indicators have improved. Access to clean water and sanitation facilities has increased, enhancing the quality of life for people. India's commitment to achieve the SDGs is evident through policy initiatives, partnerships, and data-driven approaches to track sustainable progress and efforts towards achieving these sustainable development goals.

It is observed in developing and transitional countries that there is a negative impact of the changing environment and the growing inequality, and the positive impact of the goals and how they are helping to create better opportunities for the local communities. It is necessary to use this momentum and keep pushing towards achieving the goals, so better world can be created for everyone.'

### EDUCATION AND SDGS

SDG'S have a great influence upon the scenario of Indian Education. While progressing towards attaining the 2030 education targets set by the United Nations, continued efforts are needed to address persistent challenges and must be ensured the quality education is accessible to all, leaving no one behind.

SDG's are serving as cornerstone in reducing inequalities by providing all the communities with access to quality education. India's efforts in the direction have led to decline in wealth inequalities with the gain coefficient decreasing from 35.9 in 2020 to 34.6 in 2023. Between 2015 and 2021, there is an increase in worldwide primary school completion rate, retention rate found to be increased at primary and secondary levels of education. Many programs are launched and implemented to achieve the educational SDGs in India. Various states with the help of central government also implemented useful programs to attain the universal and sustainable educational goals.

As we are progressing towards achieving the goal we have to face many challenges. One of the primary challenges in achieving the SDGs is the persistence of inequality within and between countries. Economic disparities, conflict, unequal access to education and healthcare, discrimination based on gender, race, and socioeconomic status hinder progress towards many of the goals. Economic constraints, along with issues of learning outcomes and dropout rates, persist in many areas, underscoring the need for continued global commitment to ensuring inclusive and quality education for all. Low levels of information and communications technology (ICT) skills are also a major barrier to achieving universal and meaningful connectivity.

The Covid 19 pandemic has given both enormous problems as well as several opportunities for the countries to achieve the SDGs set out according to the agenda by the year 2030. The pandemic is bound to have consequences that will have an impact for years to come. The negative impact on all 17 goals has already endangered the achievements made earlier. It is necessary to boost the speed of the development for achieving the sustainable development goals.

Gender equality plays an important role in achieving the SDGs. Women and girls are one of these groups.

About 40 per cent of countries have not achieved gender equality in primary education. These disadvantages in education also translate into lack of access to skills and limited opportunities in the labor market for young women. (The Sustainable Development Goals Report 2023).

## INDIAN EDUCATION AND SDGS

If 'learning for all' is not given top most priority, if clear and achievable goals are not set, if teachers and parents are not supported in their efforts to help children learn, India will lose all the potential benefits of bringing every child to school. For a bright and hopeful future, whether as individuals, as families or even as a country, we must aim for "every child in school and learning well." (Rukmani Banerji, ASER, 2016)

The goal of SDG 4 is to ensure inclusive and equitable quality education and promote lifelong learning opportunities for all. In the Indian context, SDG 4 is particularly significant given the country's large population and its commitment to providing education for all. One of the main challenges is the quality of education, particularly in rural areas. There is also a significant gender gap in education, with girls having lower enrollment rates than boys. The COVID-19 pandemic has further widened the existing inequalities in education, with millions of students being unable to attend school due to school closures and a lack of access to digital learning resources. SDG 4 plays a pivotal role in addressing this issue by ensuring equal access to education. In 2020, India witnessed a significant increase in female literacy rates, reaching 73.5%, a promising step towards gender equality (SDG 5).

India has achieved significant progress towards the goal of Education for All. Constitutionally several key programmes and policies have been initiated to provide free and compulsory education to all children in the age group of six to fourteen years as a Fundamental Right. Initiatives such as Sarva Siksha Abhiyan (SSA) and Right to Education (RTE) have given much required impetus to education system in India. Though it has significantly improved the enrolment rates across the country in primary education, but the challenge of quality in terms of learning outcomes remains to be addressed.

(GOI, Economic Survey 2016-17).

Quality Education plays a vital role for sustainable development. From reducing poverty and inequalities to promoting gender equality and environmental awareness, SDG 4 gives the way for progress across multiple SDGs. As India continues to prioritize and invest in quality education, it takes significant strides toward a sustainable and prosperous future for its citizens and the world. The journey may be ongoing, but the impact of SDG 4 on India's sustainable development story is undeniable, creating a brighter future for all.

## INTEGRATING SDGS INTO CURRICULUM

Educational sustainable development is simply one of several strategies for reducing poverty. Still, its impacts could have long-term positive effects that benefit the community in general and encourage sustained development, which is also an objective of Goal 8's related Employment and Economic Growth.

Education for Sustainable Development means including key sustainable development issues into teaching and learning; for example, climate change, disaster management and risk reduction, biodiversity, poverty reduction, and sustainable consumption for everyone.

For integrating SDGs in education the first step is to set targets and objectives that will be achieved by the learners by the end of course or module. The objectives must include knowledge, skills, values, and attitudes that needed to be developed in the learners. To relate the objectives with the SDGs is very essential stage. The SDG indicators, targets, and themes can be used as a reference to guide the objectives, learning outcomes.

The next step is to select the content and methods that will be helpful to deliver the learning outcomes. A variety of sources, such as reports, articles, videos, podcasts, case studies, simulations, games, or projects etc. should be provided to learners with relevant and diverse information and perspectives of the SDGs. Educational institutes can use different methods, such as lectures, discussions, debates, group work, peer feedback, or self-assessment, to facilitate active and collaborative learning to imbibe the SDGs.

The final step is to design the assessment tools that will measure learners' progress and achievement related



with the already set learning outcomes. Teachers can use formative and summative assessments, such as quizzes, essays, presentations, portfolios, or rubrics, to evaluate the learners' knowledge, skills, values, and attitudes. They can also use self-assessment and peer assessment, as well as feedback and reflection, to encourage the learners to monitor and improve their own learning. All educational institutes can play a vital role in the development of curriculum, deciding teaching learning strategies and evaluation for the development of sustainable development goals.

For integrating SDGs in education various curricular, co-curricular and extra-curricular activities can be organized at various levels of education right from primary to higher level taking into consideration the age and interest of students.

Following activities can be arranged for integration of SDGs into curriculum

Debates, drama and plays, book clubs, sports, drawing and painting, student council, cooking, art clubs, workshops, exhibitions, talent shows, youth clubs, environmental group, field visit, trips, quiz, puppetry, community service peer discussions photography theater etc.

By integrating the SDGs into curriculum and teaching learning strategies, higher education institutes in India can help their students in developing the knowledge, skills and attitudes required to contribute for sustainable development in India. You can also enhance your learners' global citizenship competencies and prepare them for the challenges and opportunities of the 21st century. You can also inspire them to take action and contribute to sustainable development in their own communities.

There is a need to increase the access of education at various levels for the marginalized sections, and strengthen management and planning in the primary education system. Moreover, including the stakeholders, namely parents, teachers, school management and local communities is important for goal setting, implementation, and attainment. Promotion of skill development through incentives involving scholarships needs to be enhanced, along with improving the basic IT competencies of the students.

According to United Nations SDG Index and dashboard reports 2023. Which assesses countries progress towards the SDG'S the SDG index Rank of India is 112 out of 166 countries with an overall score of 63.5 %. This scenario can be changed and it is possible by integrating sustainable development goals into the education.

## REFERENCES

1. Bartram, Jamie; Brocklehurst, Clarissa; Bradley, David; Muller, Mike; Evans, Barbara (December 2018). "Policy review of the means of implementation targets and indicators for the sustainable development goal for water and sanitation". *npj Clean Water*. 1 (1): 3. doi:10.1038/s41545-018-0003-0. S2CID 169226066. Text was copied from this source, which is available under a Creative Commons Attribution 4.0 International License
2. Goal 4: Quality education". UNDP. Archived from the original on 11 September 2018.
3. Hashim, A., & Firdaus, A. N. F. A. (2019). Sustainable development goals and capacity building in higher education in Malaysia and ASEAN.
4. Holzhacker, & D. Agussalim (Eds.), Sustainable Development Goals in Southeast Asia and ASEAN (pp. 125-142)
5. Meschede C, The sustainable development goals in scientific literature: a bibliometric overview at the metalevel. *Sustainability*, 12(11) (2020) 4461. 6
6. Ramana, N. M., & Ghoshalb, S. (2021). New education policy-2020 of India is in line with goal 4 of the United Nations sustainable development goals (SDG 2030). *Delhi Business Review*, 22(2), 75-84.
7. Sharma, P., & Gulati, D. D. K. (2022). Role of higher education: Alignment of new education policy with the millennium development goals. *BSSS Journal of Education*, 11(1), 42-51.
8. Surana K, Singh A & Sagar A D, Strengthening science, technology, and innovation-based incubators to help achieve Sustainable Development Goals: Lessons from India, *Technol Forecast Soc Change*, 157 (2020) 120057.
9. Sustainable Development, International Institute for Sustainable Development (IISD), 2021, [<https://www.iisd.org/about-iisd/sustainable-development>](7 Feb 2022)]

10. Sweileh W M, Bibliometric analysis of scientific publications on “sustainable development goals” with emphasis on “good health and well-being” goal (2015–2019), *Glob Health*, 16(1) (2020) 1–13. 7 UKRI India Impact Report, UK-India:P
11. Thampi A, Where does India stand on the sustainable development goals? Progress and challenges, in *Social Development and the Sustainable Development Goals in South Asia*, (Routledge) 2019, 49–73. 11.
12. "The 17 Goals". Sustainable Development Goals.
13. UNGA, A/RES/70/1: Transforming our world: The 2030 agenda for sustainable development (United Nations General Assembly), 2015.
13. United Nations, The sustainable development agenda, 2020, [<https://www.un.org/sustainabledevelopment/developmentagenda/>](12 Jan 2022)
14. Yusof, M. I. B. M., & Ariffin, M. (2020). A journey towards sustainability: A review on sustainable development implementation in Malaysia. *IOP Conference Series: Earth and Environmental Science*.

# The Transformative Role of Educational Institutions in Shaping Responsible Global Citizens

**Vijay Sadashiv Sutar**

Ph.D. Student  
Department of Education  
Shivaji University  
Kolhapur, Maharashtra  
✉ svijay2763@gmail.com

**R. B. Vhanabatte**

Professor and Head  
Department of Education  
Sadguru Gadage Maharaj College  
Karad, Maharashtra  
✉ rbvazad@gmail.com

## ABSTRACT

Global citizenship is all about encouraging young people to develop the knowledge, skills and values they need to engage with the world. It is related with how we use and share the resources fairly and uphold the human rights of all with equal importance and share. A global citizen is someone who is aware of and understands the wider world and their place in it. It is not an additional subject, it's a framework for learning and reaching beyond education to the wider community. Education of global citizenship aims to empower learners to understand their active roles to face and resolve global challenges and to become active contributors to a more peaceful, tolerant, inclusive, and better world. Transformative education involves teaching and learning aimed to motivate and empower happy and healthy learners to take enforced decisions and actions. Education can only be transformative when students feel valued acknowledged, safe and are included in the learning community as full and active members. Global citizenship education is transformative, it is a lifelong pursuit that involves both formal learning and practical experience. For the development of global citizenship educational institutions have to change their role. Education for global citizenship should be target oriented, well planned and innovative. Educational institutions have to make necessary changes in their policies, curriculum, teaching learning strategies etc. for the development of global citizenship education.

## GLOBAL CITIZENSHIP

Global citizenship is a term used to describe the social, environmental, and economic actions taken by individuals and communities who recognize that every person is a citizen of the world. Global citizenship is related with how decisions in one part of the planet can affect people living in a different part of it, and about how all human being share a common humanity and all are of equal worth. It also means being open to engage everyone positively with other identities and cultures. Global citizenship is also related with how we use and share the earth's resources fairly and uphold the human rights of all with equal importance and share.

Global citizenship is also related with how we use and share the earth's resources fairly and uphold the human rights of all with equal importance and share. A global

citizen is someone who is aware of and understands the wider world and their place in it. They are the citizens of the world and not merely of any country. They take an active role in their community and work with others full heartedly to make our planet more peaceful, sustainable and fairer for us and the forthcoming generations.

### Global citizenship involves

- Understanding the local and global connections and our views, values and assumptions.
- Exploring social justice issues locally and globally.
- Investigating the complexity of global issues and engaging with multiple perspectives related with the issues.
- Understanding and applying knowledge to real-world issues and the existing contexts.



The primary aim of Global Citizenship Education is nurturing respect for all, building a sense of belonging to a common humanity and helping learners become responsible and active global citizens. It aims to empower learners to assume active roles to face and resolve global challenges and to become active contributors to a more peaceful, tolerant, inclusive, and better world. Education for global citizenship will certainly help young people to develop the core competencies which allow them to actively engage with the world, and help to make it a more appropriate and sustainable place. It is a form of civic learning that needs students' active participation in every projects that address global issues of a social, political, economic, or environmental nature.

According to Oxfam, global citizenship is all about encouraging young people to develop the knowledge, skills and values they need to engage with the world. And it's about the belief that we can all make a difference. Education for global citizenship is not a subject but it is a framework for learning, reaching beyond school to the wider community. It can be advanced in classes through the existing curriculum or through new initiatives and activities for developing the global citizenship.

The concept of global citizenship is embedded in the Sustainable Development Goals though SDG 4: Insuring Inclusive and Quality Education for All and Promote Life Long Learning, which includes global citizenship as one of its targets. By 2030, the international community has agreed to ensure that all learners acquire the knowledge and skills needed to promote sustainable development, including global citizenship. Higher education institutions have a responsibility to promote global citizenship by teaching their students that they are members of a large global community and can use their skills and education to contribute to the welfare of the community.

### **Need and importance of Global citizenship**

In this 21st century the whole world is facing various challenges like climate change, violent and hateful ideologies, mass loss of biodiversity, new conflicts, pandemic situations and many more challenges. The whole education system needs to be reoriented to equip learners with knowledge, value and abilities to act for betterment of all people and the planet.

Global citizenship has vital importance to 21st century learning, and the firsthand experiences and learning that global citizens enjoy certainly. For students, becoming global citizens will be beneficiary by acquiring skills like problem-solving, communication, collaboration, and cross-cultural awareness etc. it will benefit them enormously. By arranging various well planned skill development programs students can ultimately acquire these skills.

Critical Thinking and problem solving, community and collaboration, digital literacy, cross-cultural awareness and leadership are the essential skills.

Indian culture always believed in universal brotherhood (Vasudeva Kutumbakam) which is one of the main ethos of Indian education system since ancient times that enables Indian citizens to assimilate themselves in different cultures. Global citizenship exists, and has existed, side by side with the rich heritage of India. Though it is true the varying local problems, innumerable and diverse stories of life and livelihood across the length and breadth of the country, there are considerable challenge to the realization of an underlying oneness and identification with a larger community beyond the immediate regional boundary. The values of Indian education system such as dignity, truthfulness, fairness and responsibility complement the directive principle enshrined in Article 51 (promotion of international peace and security) of the Indian Constitution are related with the concept of Global citizenship. Various educational reforms are needed as envisaged under National Education policy 2020. It also assimilated thoughts of many Indian thinkers and educators who advocated the concept of global citizenship. It is also mentioned in Hitopadesha 1.3.71, the thought that one person is related to me and another is not is that of the narrow-minded. For the broadminded, however, the whole world is one family. This broad minded view is related with global citizenship in modern era.

Globalization proved useful for fostering global citizenship. Education and lifelong learning is the key to address many of the world's problems. Of course, education alone is not a sufficient condition for resolving these problems, but it is a necessary one. It needs the fertile soil of qualitative humanistic education, grounded with democratic principles and universal human rights

that will be the seeds of political, economic, social and technological development of the globe.

After the advent of globalization, India has witnessed a remarkable pace of development and growth in every sector. Urbanization has brought with it a trend of migration, visible across all over the country. The flow of labor from rural natives to urban cities is an indicator of the rising aspirations of the common man. The rural population of India seems unprepared and lacking in incentives to truly globalize.

### **ROLE OF EDUCATIONAL INSTITUTIONS FOR SHAPING RESPONSIBLE GLOBAL CITIZENS**

When it comes about imbibing the values of global citizenship among vast population of India, Indian Education system can play a vital role in the development of global citizenship. Educational Institutions have a responsibility to promote global citizenship by fostering in educators and learners that they are members of both their local and larger global community and can use their skills and education to contribute towards these communities. Teaching as a process of passing on knowledge has existed since ancient times, changing from didactic teaching and rote learning to an inclusive method of teaching that stimulates students to acquire new knowledge and skills. The role of teachers has also evolved from the Gurukul system in ancient India to digital literacy in virtual classrooms today. A teacher today is a facilitator of learning processes, who can be seen as the anchor of education shifts to creating global citizens and can succeed in the turbulent and rapidly changing environment.

The world as we know it today is full of with conflicts, and challenges that need immediate attention. Climate change, poverty, illiteracy, hunger and violent extremism are but a few of the many issues that the world continues to grasp attention with, even today. Global citizenship is a call for action of the people to come together, understand their role and shared responsibilities of protecting the planet, fostering peace, ensuring global prosperity, respecting diversity, and advancing humanity through various partnerships. It is believed that there is no global without local and as Mahatma Gandhi said 'If you want to change the world, start with yourself.'

Education of Global Citizenship provides a lens to view issues and challenges through, what we at the Global Citizenship Foundation call as "Two-Systems Thinking". Where you "Think and Act, both global and local" instead of just "Thinking Global and Acting Local". Global Citizenship Education aims at imbibing learners the values, attitudes and behaviors that support responsible global citizenship.

Global leaders, educators, and practitioners recognize that the concept of Global Citizenship is very essential nowadays more than ever. Education for Global Citizenship inspires and empowers the learners to reflect on their biases and assumptions, to value the diversity, to develop a greater understanding of countries, communities, and cultures around the world events that shape our community and world, to explore questions about democracy, justice, inequality, governance, sustainability, and organization, to learn to work together to develop solutions that address local, national, and global challenges, to enhance knowledge, skills, and competencies to make positive contributions to society as informed and responsible global citizens, to take action towards achieving a more just, inclusive, peaceful, prosperous, secure, and sustainable world for all, and to realize one's capacity for change and the ability to play one's role as responsible global citizen.

As a result, Global Citizenship Education can prevent the existing generations from the hate, radicalization, extremism, and violence and can imbibe the values of global citizenship among the forthcoming generations, by inspiring learners to be part of the solution to the problems faced across all over the planet. Many educators have proposed teaching as a practical and effective way to learn and guide students to find their strengths and influence society positively.

### **TRANSFORMATIVE ROLE OF EDUCATIONAL INSTITUTIONS**

Transformative education involves teaching and learning geared to motivate and empower happy and healthy learners to take enforced decisions and actions. Education can only be transformative when students feel valued, acknowledged, and safe. It is needed that these students to be included in the learning community as full and active members. Education has always played

the role of cornerstone of India's rich cultural heritage, and in the 21st century, the country's educational scenario is undergoing significant transformations. With a growing population and increasing emphasis on innovation, inclusivity, and digital literacy, Indian education is at the important stage for complete change. The introduction of the National Education Policy (NEP) 2020 is a landmark development, focusing on holistic and multidisciplinary education, flexibility, and the integration of technology is able to change the scenario of the education for global citizenship.

Educational institutions can play a vital role in the development of global citizens they can empower students as leaders and teachers, incorporate global stories into the curriculum, organize classes with special purposes, arrange grants with special intention to inculcate global citizenship, can plan and implement various curricular and co curricula activities. Students and teachers can volunteer themselves for arranging multiple programs for global citizenship development. All educational institutes must change their approach which makes it possible to address the four pillars of learning that are key to ensuring learners are equipped with the skills they need to face the world as active and engaged citizens: Learning to know, to do, to be and to live together.

The formal education system which comprises schools, colleges, and universities, follows a structured curriculum designed to impart knowledge and skills across disciplines, they should design their curriculum accordingly. Online Learning is the advent of digital technology has given rise to online learning platforms, offering flexibility and accessibility for learners can arrange various compulsory activities for imbibing global citizenship. Skill development among learners can play a vital role in recognizing the importance of practical skills, vocational training institutes and skill development programs are gaining prominence, equipping learners with industry-relevant competencies focusing on the development of global citizenship.

Educational institutions can also use some innovative methods for the development of global citizenship like

1. Digital Transformation: The integration of technology in education has become a catalyst for change. Smart classrooms, e-learning modules, and

educational apps are transforming the traditional teaching and learning methods.

2. Innovative Pedagogies: Progressive educators are exploring innovative pedagogical approaches, including experiential learning, project-based learning, and collaborative teaching methods, to enhance student engagement and critical thinking.
3. Inclusive Education: Efforts are being made to make education more inclusive, addressing the needs of diverse learners, including those with disabilities. Inclusive education aims to provide equal opportunities for all students.
4. Global Collaborations: Indian educational institutions are increasingly engaging in global collaborations, fostering cross-cultural exchanges, joint research initiatives, and the sharing of best practices.
5. Curriculum Relevance: The traditional curriculum is often criticized for being outdated and not aligned with the evolving needs of the job market. There is a call for a more dynamic and industry-relevant curriculum for the global citizenship development.

## REFERENCES

1. Bawa, R.S. (2003). 'Challenges and Opportunities of Globalisation: Implications for India' in P.J.Gandhi (ed.) Globalised Indian Economy: Contemporary Issues and Perspectives, New Delhi: Deep and Deep.
2. Citizenship (2014), Edited By Richard Bellamy, Madeleine Kennedy-Macfoy, ISBN 9780415664868
3. Handbook for Parliamentarians (2005) UNHRC -UNRA (<https://www.ipu.org/resources/publications/handbooks/2016-07/handbookparliamentarians-refugee-protection-guide-international-refugee-law>)
3. Citizenship (2014), Edited By Richard Bellamy, Madeleine Kennedy-Macfoy, ISBN 9780415664868.
4. Dasgupta, B. (2005). Globalisation and India's Adjustment Experience, New Delhi: Sage.
5. Dower, N. (2003.) An Introduction to Global Citizenship, Edinburgh: Edinburgh University Press.
6. Esteva, G. and Prakash, M.S. (1992). 'Grassroots Resistance to Sustainable Development: Lessons from the bank of the Narmada'. The Ecologist, 22 (2), 45-51.
7. Faulks, K. (2000). Citizenship, London: Routledge.

8. Falk, R. (1994). 'The Making of Global Citizenship', in B. Steenbergen (ed.) *The Condition of Citizenship*, London: Sage.
9. Harris-White B, Prakash Aseem, Mishra Deepak ( Jan 2013), Researchgate, Globalisation, Economic Citizenship, and India's Inclusive Developmentalism (DOI: 10.1007/978-3-642-34568-5), Chapter 10, In book: *Citizenship as Cultural Flow: Structure, Agency and Power* (pp.187-210), Springer (ISBN 978-3-642-34568- 5).
10. Kabeer Naila, (Dec 27, 2005), *Inclusive Citizenship: Meanings and expressions*, Book-ISBN1 84277 549 9, Zed Books, Accessed in Book Format, Accessed Feb 2021
11. Kivisto Peter and Faist Thomas, (2007), *Citizenship: Discourse, Theory, and Transnational Prospects* (page 102), Wiley-Blackwell, ISBN: 978-1-405-10551-4, Book, Referred Jan- Feb 2021
12. Marshal TH (1950), *CITIZENSHIP AND SOCIAL CLASS and other essays*, Cambridge University Press.
13. Roy Anupama (2010): *Mapping Citizenship in India*, New Delhi: Oxford University Press ISBN: 9780198066743
14. Soysal NY, (1994), University of Chicago Press, *Limits of Citizenship: Migrants and Post-national Membership in Europe*, Book, Referred: Feb 2018.
15. Vuskane Linda (2011), *The Impact of Globalisation on Citizenship*, GRIN Verlag Munich (ISBN9783346098).

# Exploring Digital Communication usage of Learning Management System (LMS) Software Between Lecturer and Students in Telkom University, Indonesia

**Lucy Pujasari Supratman**

Telkom University  
Indonesia

✉ doktorlucysupratman@gmail.com

**Aep Wahyudin**

State Islamic University of Sunan Gunung Djati  
Bandung, Indonesia

✉ fwahyu2000@yahoo.com

**Nagina Mali**

Shivaji University  
India

✉ naginamali2012@gmail.com

## INTRODUCTION

Revolution Industry 5.0 is more focuses on integration between technology advanced such as AI, IoT and robotic technology with skill people and innovation that can push development system more production efficient, flexible, sustainable, and improving well-being. This matter aims to create system more production adaptive to change market demand, more focuses on experience customers, as well optimizing utilization source power limited nature. It begins when industry 4.0 already reach peaks and experts opinion that the 4.0 era can perfected. Industry 4.0 is starting introduced since 2011 intended to modernize business processes, especially in industry manufacture. This era also introduces lots technology, AI and IoT for makes it easier. Then in 2017, Japan was the first to introduce it vision from Revolution Industry 5.0. At that time, this concept calls as Society 5.0 at the CeBIT exhibition in Germany. When Industry 4.0 booms discourse that AI will replace humans, industry 5.0 precisely give the balance between technology usage and human.

In the era of industry 5.0 (5IR), the world of education has changed with bring up various development technology. Development educational technology give positive impact in the world of education, one of them with makes the learning process easier (Supratman & Wahyudin, 2021). System learning conventional at first done in a way stare face, then in the 5IR era you can done in a way distance remote (online). Learning with use this online system become transformation new in technology education used. For plan system

more learning interactive. Learning Management System (LMS) is terms in the world of technology and developed in a way specifically so you can manage and facilitating and being a media for process learning distance (Rakhmawati et al., 2021).

System online learning such as LMS is a learning process with use the internet more prioritize ability student in receive and also process information. Yunus (2019) said that key success in the online class it's in how technology the can used as communication media effective in learning between lecturers and students.

Telkom University has been named the number one best private university make exploration via LMS as part important in activity Study teach between lecturers and students. LMS is a learning system that presents various choice learning. This is Telkom University LMS display.



Source: Telkom University LMS System Website (2024)

Digital Platform E-Learning LMS (Learning Management System) Telkom University has objective for make reject measuring utilization technology and



information so that utilization technology education This create a learning process teach become more effective. Element most important thing to use for apply Telkom University LMS (Learning Management System) online learning as well manage How activity learning the can walk simultaneously with results the assessment net. In other words, this LMS often also called as the platform is e-learning or as one of the applications that creates virtualization in the learning process teach with utilize tool electronic. Telkom University has E-Learning LMS (Learning Management System). diverse features that can fulfil need student in do online learning, makes it easy access to source reference, assessment moment exam, collection assignment, provide good feedback as well as make communication can done with using discussion forums, mailing, or chat. Through this LMS, students can also see modules existing learning provided, take or download required assignments and quizzes done, can see timetable discussion by online.

Telkom University's E-Learning LMS (Learning Management System) becomes very important thing in management education high modern, esp in facilitate online learning . From that's a question study in script This is “ How role Telkom University LMS e-learning features in help me communication learning between lecturers and students ? ”.

**RESEARCH METHOD**

Methods in research This use method study studies library, where in study it also uses secondary data collected from information articles, books and journal. Research This arranged based on idea Supported authors with secondary data and made as base in determine discussion about utilization learning management system (LMS) technology used as means online or online learning during the pandemic. Secondary data collection This done via the Google Scholar database with criteria article language Indonesian , full text and also uses keywords.

**FINDING AND DISCUSSION**



E-Learning LMS (Learning Management System) Telkom University displays various type varied digital teaching materials. This works for simplify the knowledge transfer process as well as fulfil need different students in the learning process. Following this is types available teaching materials in E-Learning LMS (Learning Management System) Telkom University.

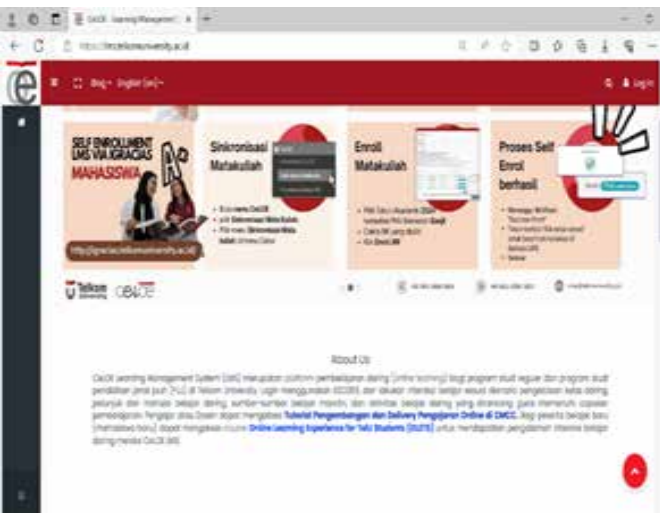
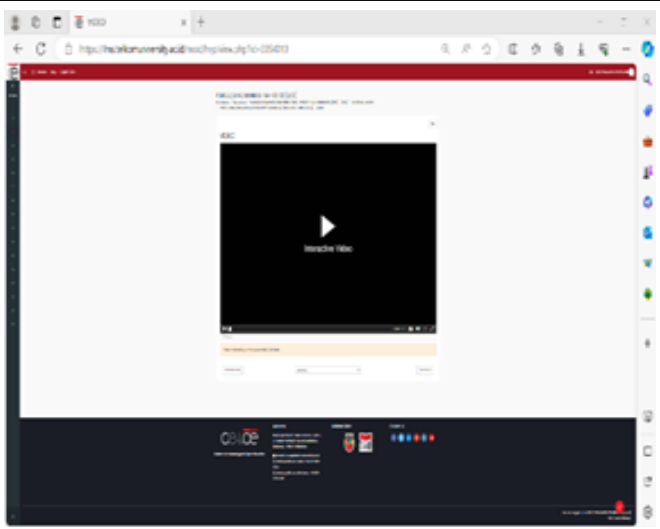
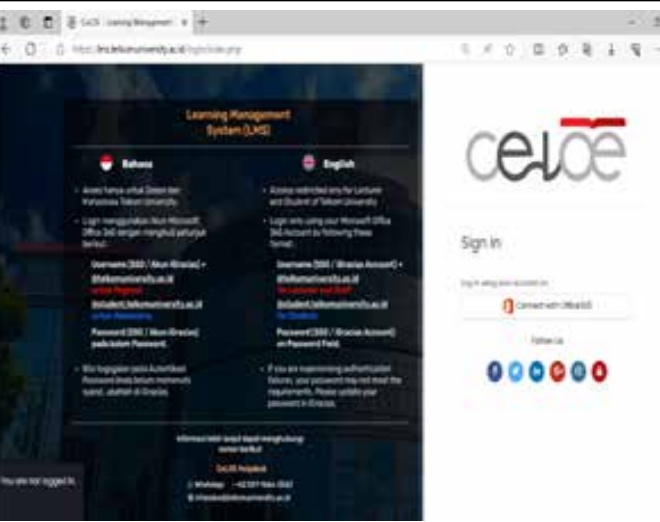

Source: Telkom University LMS Sytem Website (2024)

No	Features	Appearance	Description
1	Text material		Text material is form base from teaching materials . this material can form notes lectures , articles scientific , abstract , paper, and so on . Text material This can served in various formats such as PDF, Word, or HTML.

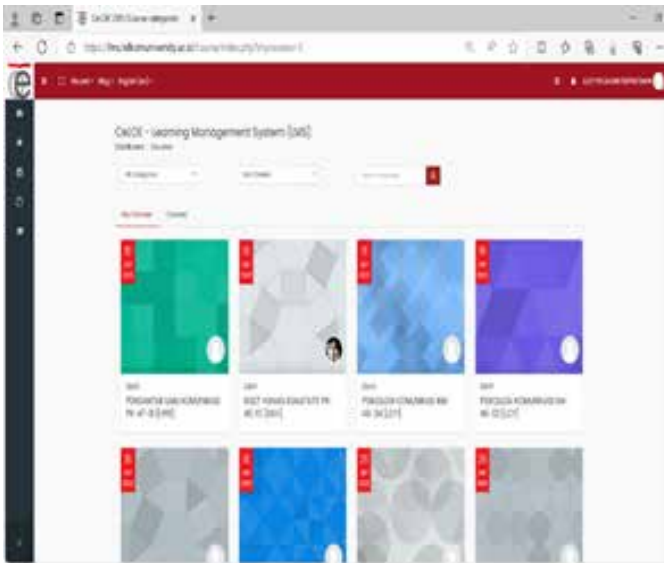
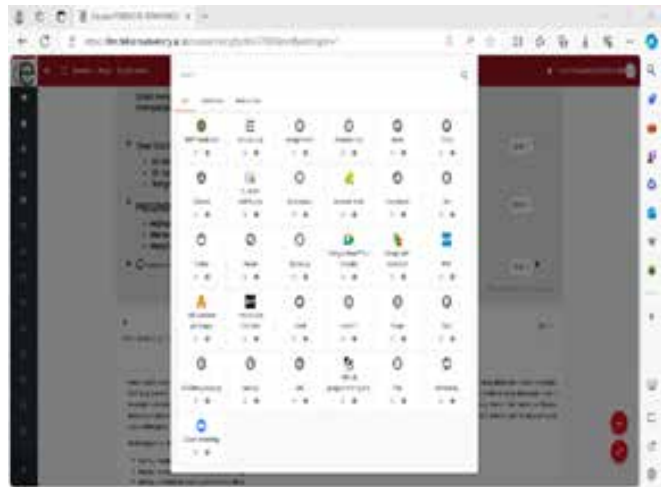
<p>2</p>	<p>Audio Material</p>	 <p>The screenshot shows the 'SELF ENROLLMENT LMS VIA GRAKAS MAHASISWA' section of the DCC LMS. It includes steps: 'Sinkronisasi Matakuliah', 'Enroll Matakuliah', and 'Proses Self Enroll berhasil'. Below the steps, there is an 'About Us' section describing the DCC Learning Management System (LMS) as a platform for providing learning (online learning) and program study regulation (program studi) for students and staff.</p>	<p>Audio materials can give alternative for more students _ Like Study with listen . Audio material is possible form recording voice the lecturer explains material, interviews with expert, or material studying in podcast form .</p>
<p>3</p>	<p>Video Material</p>	 <p>The screenshot shows a video player interface with a play button in the center. The video title is 'Introduction Video'. The player is embedded in a web browser window.</p>	<p>Video material is generally very liked by students Because can increase understanding they with give visualization to the concepts taught . This video can containing recording lectures , demonstrations practice , panel discussion , or learning through media such as YouTube.</p>
<p>4</p>	<p>Discussion forum</p>	 <p>The screenshot shows the login page of the DCC Learning Management System (LMS). It features a 'ce:looe' logo and a 'Sign in' section with fields for 'Email/Username' and 'Password'. There are also social media icons for Facebook, Twitter, and YouTube.</p>	<p>Discussion forum works as a medium of interaction between lecturers and students or between student . Discussion can taking place use text , sound , or video.</p>

<p>5</p>	<p>Quizzes and Exams</p>		<p>LMS needs to also have facility For create and manage quizzes and exams . This matter important For measure extent of understanding and absorption material by students .</p>
	<p>Quizzes and Exams</p>		
	<p>Video Conference Facilities</p>		<p>Video conferencing facilities are important in learning distance Far . With facility here , lecturers and students can communicate direct in real time.</p>

Source: Research result (2024)

L M S



needs to also have facility to create and manage quizzes and exams. This matter important For measure extent of understanding and absorption material by students.

The teaching materials displayed in Telkom University's E-Learning LMS (Learning Management System) have role Important for Use Variations in Teaching Materials. This matter aim For fulfil need diverse learning from student . Varied learning can enrich experience learn , improve interest learn , and help student understand material more in . Use E-Learning LMS (Learning Management System) Telkom University of course showing benefit big for lecturers and students Because can each other give profit in side learning. System E-Learning LMS (Learning Management System) Telkom University is designed e-learning system For do management , distribution , planning as well as do evaluation in Suite learning . Great benefit E-Learning LMS (Learning Management System) Telkom University , activity Study teach will Far more easy done although in learning distance far and can optimizing activity Study teach . Based on results interview with a number of lecturers and students at Telkom University, findings benefit from use E-Learning LMS (Learning Management System) Telkom University is:



Source: Research result (2024)

Besides being easy used, LMS this is possible too accessed wherever and whenever. Just using application of course, student can accept material provided lecturer very easily and quickly. LMS Telkom University is

accessible and brings innovation enabling technology provision more education, spacious and flexible. For example, online learning platforms, online courses and content digital education makes it possible access more education easy and affordable for individuals around the world. Practicality in use LMS this apparently can make it easier for students in understand the learning process teach with effective and efficient. Using LMS, this student can monitor and track by lecturers. Lecturers can monitor in a way periodically to student about understanding they to existing material be delivered. Lecturer can increase progress and performance student. LMS can also utilized as means good discussion. Lecturers and students can do interaction interesting via video conference, online discussions, even features interactive others who can arranged with LMS system. Usage website and application systems, LMS this can help you in plan, manage and convey various system learning both online and offline. This student can monitored and tracked by lecturers. Lecturers can monitor in a way periodically to student about understanding they to existing material be delivered. Lecturer can increase progress and performance student. System LMS This can give convenience to students and teachers for interact one each other though from based distance far. Which is distribution material the use capable internet technology. With use LMS , everything make things easier for teachers for provide more learning and interesting. Naturally with interactive features. Usually can done through discussions, file sharing, and forums are provided.

For online learning the implementation process also requires support mobile devices that can used For access all no information limited time (Gikas & Grant, 2013). Apart from that, various learning media can chosen as means support online learning . Various various types of Learning Management Systems (LMS) are presented as an online learning media (Sicat, 2015). In implementation system e- learning exists a number of components are a must Also pay attention as in (Surjono , 2013). Prepare content learning in accordance with learning achievements. Using method learning with provide examples and practice for more makes it easier student in the learning process. When using e-learning media you can use text nor picture with diverse and interesting appearance. Using this e-learning media

can done in a way direct nor can done in a way individual. With using the e-learning learning model can build outlook together about how use and utilization technology education at this time.

## CONCLUSION

Development technology bring change in the role of the teacher. In the era of the Revolution Industry 5.0, more teachers works as facilitators and mentors, who help student develop Skills critical thinking, creativity, and collaboration. Teachers also need it become skilled in use technology education, analyzing learning data, and designing experience interesting and relevant learning. Enhancement Accessibility development and technology can increase accessibility to education with provide material online learning, courses distance remotely, and digital tools can be accessed by students anywhere and anytime. Technology can help create experience more learning, interactive and interesting, simulation and, multimedia. It can increase engagement and understanding student. LMS also can personalization learning with help education technology and can become more personal and adaptive.

## REFERENCES

1. Gikas, J., & Grant, M. M. (2013). Mobile Computing Devices in Higher Education: Student Perspectives on Learning With Cellphones, Smartphones & Social Media. *Internet and Higher Education*.
2. Rakhmawati , NIS, Mardiyah , S. Fitri , R, Darni , D, & Laksono , K (2021). LMS Development in the Covid 19 Pandemic Era in Early Age Children's Education. *Journal Obsession : Journal of Early Childhood Education* , 6 (1), 107-118. <https://doi.org/10.31004/obsessi.v6i1.991> .
3. Sicat, USA (2015). Enhancing College Students' Proficiency in Business Writing Via Schoology. *International Journal of Education and Research*.
4. Surjono , HD (2013). *Building a Moodle- Based E-Learning Course* (2nd ed.). UNY PRESS
5. Supratman, Lucy and Aep Wahyudin. Communicating the Collaborative Lecturing Style to Millennial Learner in the Classroom. *Nyimak: Journal of Communication*. Vol 5, Issue 2. 2021. Pages 189-202.
6. Yunus, Mohammad. (2019). *Online Learning*. Jakarta: Open University.

# Rain Water Harvesting

**S. S. Nale, A. D. Patil**

Assistant Professor and Faculty  
Dr D Y Patil Pratishthan's College of Engineering  
Salokhenagar, Kolhapur, Maharashtra  
✉ nalesandeep09@gmail.com  
✉ amar9205@gmail.com

**R. V. Jadhav**

Head  
Civil department and Faculty  
Dr. D. Y. Patil Pratishthan's College of Engineering,  
Salokhenagar, Kolhapur, Maharashtra  
✉ rashmijadhav.dypsn@gmail.com

## ABSTRACT

Water scarcity is serious problem throughout the world for both urban & rural community. Urbanization, industrial development & increase in agricultural field & production has resulted in over exploitation of groundwater & surface water resources and resultant deterioration in water quality. The conventional water sources namely well, river and reservoirs, etc. are inadequate to fulfill water demand due to unbalanced rainfall. While the rainwater harvesting system investigate a new water source. The aim of the present study is to use rainwater and thus taking close to the concept of nature conservation. In this study, the rain water harvesting (RWH) system is analyzed as a alternative source of water at campus of Dr. D. Y. Patil Pratishthan's College of Engineering, Salokhenagar in the state of Maharashtra, India. The expected outcome of the study is the implementation of rainwater harvesting system for catchment area of our college building. The result analysis shows that the present RWH system collected 16,73,100 litres in year 2023. The developed system satisfies the campus requirements and can be implemented in rural areas by considering almost all the technical aspects.

## INTRODUCTION

### Rainwater Harvesting Systems and its Features

Rainwater Harvesting is a simple technique of catching and holding rainwater where its falls. Either, we can store it in tanks or we can use it to recharge groundwater depending upon the situation.

*Features of Rainwater Harvesting are*

1. Reduces urban flooding.
2. Ease in constructing system in less time.
3. Economically cheaper in construction compared to other sources, i.e. dams, diversion, etc.
4. Rainwater harvesting is the ideal situation for those areas where there is inadequate groundwater supply or surface resources.
5. Helps in utilizing the primary source of water and prevent the runoff from going into sewer or storm drains, thereby reducing the load on treatment plants.

6. Recharging water into the aquifers which help in improving the quality of existing groundwater through dilution.

### Components of Rainwater Harvesting System

A rainwater harvesting system comprises of components for - transporting rainwater through pipes or drains, filtration, and tanks for storage of harvested water. The common components of a rainwater harvesting system are:-



Fig.1 Rain Water Harvesting System

1. **Catchments:** The surface which directly receives the rainfall and provides water to the system is called catchment area. It can be a paved area like a terrace or courtyard of a building, or an unpaved area like a lawn or open ground. A roof made of reinforced cement concrete (RCC), galvanized iron or corrugated sheets can also be used for water harvesting.
2. **Coarse Mesh:** It prevents the passage of debris, provided in the roof.
3. **Gutters:** Channels which surrounds edge of a sloping roof to collect and transport rainwater to the storage tank. Gutters can be semi-circular or rectangular and mostly made locally from plain galvanized iron sheet. Gutters need to be supported so they do not sag or fall off when loaded with water. The way in which gutters are fixed mainly depends on the construction of the house, mostly iron or timber brackets are fixed into the walls.
4. **Conduits:** Conduits are pipelines or drains that carry rainwater from the catchment or rooftop area to the harvesting system. Commonly available conduits are made up of material like polyvinyl chloride (PVC) or galvanized iron (GI).
5. **First-flushing:** A first flush device is a valve which ensures flushing out of first spell of rain away from the storage tank that carries a relatively larger amount of pollutants from the air and catchment surface.
6. **Filters:** The filter is used to remove suspended pollutants from rainwater collected from rooftop water. The Various types of filters generally used for commercial purpose are Charcoal water filter, Sand filters, Horizontal roughing filter and slow sand filter.
7. **Storage facility:** There are various options available for the construction of these tanks with respect to the shape, size, material of construction and the position of tank and they are:-

Shape: Cylindrical, square and rectangular.

Material of construction: Reinforced cement concrete(RCC), masonry etc.

Position of tank: Depending on land space availability these tanks could be constructed above ground, partly underground or fully underground. Some maintenance measures like disinfection and cleaning are required to ensure the quality of water stored in the container. If harvested water is decided to recharge the underground aquifer/reservoir, then some of the structures mentioned below are used.

## ABOUT RAIN WATER HARVESTING

### Objective of Rainwater Harvesting at DYP Salokhenagar

The campus of this institute is situated at the Kalamba Ring Road, Kolhapur city over an area of 3.5 acres of land. The institute area is at the center of the locality and surrounded by the residential areas. There are five departments, total strength of campus including students and staffs will be more than 1200.

Thus, with this present strength and also with the expansion programmes, campus should also increase its facilities and maintenance requirements. Thus water is the most natural resource which is being always in high demands by human being and is indispensable part of the life. For institute water demand per head is 45 liters, to full fill this demand we plan for Rainwater Harvesting at DYPCOE, Salokhenagar, Kolhapur.

Main objectives of Rainwater Harvesting are as follows:

1. To meet the rising demand of water needs.
2. To raise the underground water table .
3. To reduce soil erosion.
4. It helps preventing urban flooding due to excess rain.
5. It can reduce the water bill in urban areas.
6. Rain water can be used for non-drinking purposes.

As discussed earlier in the section of introduction – importance of rainwater harvesting at DYPSalokhenagar. We clearly came to know all the advantages which we can draw out by implementing this small but highly efficient technique in the campus. Thus to increase the potential, benefits of this system and draw maximum advantages from it, we need to have large rooftop areas which will be going to act as catchment areas. More

the catchment areas more will be the surface runoff and thus more will be the amount of harvested water.

**Table 1: Calculation of Roof Top Area of All Building**

Serial no.	Building Name	Roof top area (m <sup>2</sup> )
01	College building	1859 m <sup>2</sup> (20000 Sq.ft)

**Table 2: Details of Rain Water Harvesting System**

Sr. No	Particular	Details
1	Rain water filter installation date	9 October 2020
2	Total area of roof top covered in Rain Water Harvesting	20000 Sq.ft (1859 m <sup>2</sup> )
3	Average rainfall in Kolhapur City in current year 2023	900 mm
4	Collection of rain water during whole rainy season year 2023	1673100 lit
5	Cost of water for colleges as per municipal corporation	Rs. 40/1000 lit
6	Cost saved in year 2023 through Rain Water Harvesting	Rs. 66924.00
7	Initial cost of filter including installation	Rs. 4000
8	This current year profit	Rs. 62924.00
9	Per capita water requirement for colleges	45 lit/head/day

**Table 3: Technical Specifications & Parameters of Filter**

Overall Dimension	On Site Installation
Suitable Up to Areas	500 SQ MTRS
Capacity	480 LPM
Filter Element	SS-304 Screen
Mesh Size	250 Microns
Inlet	110 MM

Clean Water Outlet	90 MM
Drain Outlet	110 MM
Housing	High Density Polyethylene
Efficiency of Filter	Above 90%
Source of Power	Gravity

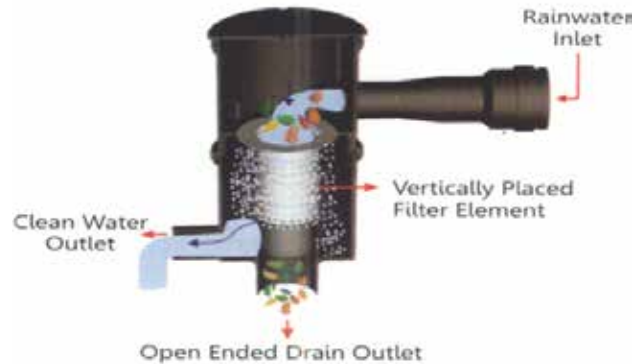

**Fig.2: Rain Water Harvesting Filter**

**BENEFITS**

**College**

- Less cost.
- Helps in reducing the water bill.
- Decreases the demand for water.
- Reduces the need for imported water.
- Promotes both water and energy conservation.
- This technology is relatively simple, easy to install and operate.

**Student**

- Addition in technical knowledge.
- Awareness regarding Rain Water Harvesting.
- Scope in research of Rain Water Harvesting.
- Scope in making government policy regarding Rain Water Harvesting.

**Nation**

- It reduces soil erosion, storm water runoff, flooding, and pollution of surface water with fertilizers, pesticides, metals and other sediments.



- It is an excellent source of water for landscape irrigation with no chemicals and dissolved salts and free from all minerals.
- Reduces urban flooding.
- Suitable for irrigation.
- Increases ground water table.
- Supplemental in drought.



**Fig.3: Filter arrangements & Water storage tank**



**Fig.4: Rain Water Harvesting Pipe arrangements**

## CONCLUSION

Recharge of ground water table is a gradual process, we can not suddenly increase the ground water table after constructing recharge structures, therefore by constructing any type of recharge structure, we can give our contribution in ground water recharge. This will help to rejuvenate the depleting ground water resources. Also help to save the little amount of rain water which used to drain away from many years. Thus it is concluded that implementation of RWH system of Dr. D. Y. Patil Pratishthan's College of Engineering, Salokhenagar campus would result in the form of the best approach to deal with present scenario of water scarcity and utilizing huge quantity of 16,73,100 litres in a year in college campus.

## REFERENCES

1. Pacey, Arnold and Cullis, Adrian, (1989), "Rainwater Harvesting: The collection of rainfall and runoff in rural areas", Intermediate Technology Publications, London
2. P. K. Singh, Bhaskar Singh and B. K. Tewary, (2006), "Rooftop Rainwater Harvesting for Artificial Recharge to Ground Water: An Urgent Need of Present Century".
3. Reddy P.Sai Rukesh and Rastogi A.K., (2008), "Rainwater Harvesting in hostel 12 and hostel 13 of IT Bombay", The Indians society for Hydraulics and Journal of Hydraulic Engineering.
4. Rishab Mahajan, Prof. Shakti Kumar and Dr. R. K. Khitoliya, (2006), "Rain Water Harvesting: A Viable Solution To Conserve Water".
5. R. K. Parghane, S. P. Kulkarni & A. W. Dhawale, (2006), "Rainwater Harvesting and Recharging Groundwater".
6. R. M. Dhoble and Dr. A.G. Bhole, (2006), "Review of rain water harvesting in India".
7. Singh P.K., Singh B. & Tewary B.K., (2006), "Roof Top Rainwater Harvesting for Artificial Recharge to Ground Water : An Urgent Need of Present Century".
8. S. R. Asati and Abhijit Deshpande, (2006), "Importance of Rain Water Harvesting in Current Scenario".

9. Aditya Kumar Patra and Sneha Gautam,(2011) “ A pilot scheme for rooftop rainwater harvesting at Centre of Mining Environment, Dhanbad”.
10. Agarwal Aand Narain S, 1999. Making water management everybody’s business: water harvesting and rural development in India.
11. B. Sitaram Shetty Rain Water Harvesting in Costal Districts of Karnataka State, India. National Seminar on Rainwater Harvesting and Water Management 11-12 Nov. 2006, Nagpur.
12. Dr. N. M. Kanhe & Dr. A. G. Bhole “Study of Experiments on Roof Top Rainwater Harvesting and Surface Rainwater Harvesting for Recharging of Wells”.
13. Er. L. K.Bisoyi, (2006),” Rain Water Harvesting – An ultimate need in 21st Century”.

# Institutionalization of Sustainable Development Goals in Educational System: Navigating the Fifth Industrial Age Science Teaching for achieving Sustainable Development Goals

**Vidya Shivaji Suryawanshi**

Ph. D Student  
Department of Education  
Shivaji university  
Kolhapur, Maharashtra

**Nandkumar Dhondiram Dhanawade**

Professor  
Aazad college of Education  
Satara, Maharashtra

## ABSTRACT

This article discusses the sustainable development goals for science teaching with reference to NEP 2020 to promote quality education, scientific abilities and sustainable development in India's primary education institutions. Common objectives of Sustainable Development Goals and NEP 2020 related to promoting quality education, holistic development of students, science teaching learning methods, gender equality, innovations, experiment and research. The curriculum of primary education institution in India can help their students develop knowledge, Skills, Scientific abilities, required to contribute to sustainable development in India.

## INTRODUCTION

Sustainable development is very important for human existence. In today's world, due to the increasing progress of science natural resource wealth is used in a very large scale for human happiness. It is the need of the hour that the teaching of science will be very important. To achieve the goal of sustainable development, it is necessary to use various teaching methods for science teaching effectively in the classroom. Today, according to the guidelines of the changing National Education Policy 2020, it is the need of the time to use the taught teaching methods and strategies in science teaching for sustainable development, we have to teach science with zero hunger, good health and quality education, gender equality, clean water and sanitation, affordable and clean energy, industry, innovation and infrastructure, sustainable cities and communities, climate action for achieving sustainable development goals. So it is necessary to analyse the content of science subject at the upper primary level and accordingly, science teaching methods and It is necessary to decide the strategy, to motivate the students to think, to discuss and work in groups, to act based on various concepts, to find prior knowledge, to create concept pictures, to do

experiments, to reach conclusions by observing and to make inferences and create a learning environment in the classroom.

## SUSTAINABLE DEVELOPMENT GOALS (SDGS)

The sustainable Development Goals (SDGs) are a group of 17 objectives that will be accomplished by 2030 and were presented by the UN General Assembly in 2015. Sustainable development stresses the importance of institution that are willing to integrate economic, social and environmental objectives at each level of policy development and decision Making.

Development that meets the needs of the present without compromising the ability of future generation to meet their own needs.

(United Nations General Assembly 1987. P. 43)

## NATIONAL EDUCATION POLICY 2020 (NEP)

The National, education policy (NEP) 2020 is a Policy released in July 2020 by the government of India. The policy objectives to transform the Indian education



to meet the sufficient needs of the 21st century. Some important aspects of NEP 2020 includes the introduction of a 5+3+3+4 structure of school education. It focuses on curriculum content will be reduced in each subject and focused on critical thinking, inquiry based, problem solving, analysis based learning. NEP also seeks to promote inclusive and equitable education, gender equality and provide universal access to quality education. The implementation of NEP 2020 will require collaboration between the central and state governments, educational stakeholders and civil society.

### **SUSTAINABLE DEVELOPMENT GOALS IN THE CURRICULUM**

Sustainable Development Goals in the curriculum framework include the some themes and objectives of the SDGs such as sustainable development, gender equality, clean water and sanitation, climate action and affordable and clean energy. The curriculum can be designed in a way that promotes problem solving, critical thinking, classifying, inferring, predicting and value based learning to students with skills, abilities and knowledge needed to achieve the SDGs. This will help in formation of knowledge and engaged learner in the implementation of the SDGs.

### **SCIENCE TEACHING METHODS FOR SUSTAINABLE DEVELOPMENT**

#### **Project method**

The project method of teaching is a medium of instruction in which the students are given a number of projects or situations out of which they have to choose the problem they want to solve. After choose the problem they will come to the solution to the problem on their own. This is the most proactive approach to learning. In this case of the project method of teaching consider the role of the teacher as a guide. The responsibility of the work falls on the students since even the curriculum content and technique. So this method is completely student centric. This can prepare students to become responsible citizens who can contribute their work to achieve sustainable development goals.

#### **Hand- on learning**

Hand- on learning means learning by doing. This is the instructor engage with students in direct experience

and focused reflection to enhance student knowledge, skillset and values. In Hands-on learning students allow to learn through experiencing something and can give them an opportunity to immerse themselves in a learning environment while putting their acquired skills to use and building new, skills for achieving sustainable development goals.

#### **Laboratory method**

Laboratory method are based on inventions of scientific principles involving all branches of science such as, biology, chemistry, physics and all aspects of medical science. The scientific principles used and the steps that are required to produce results. The Laboratory scientist follows step-by-step procedures until the end product a test result is achieved. In this way student also perceive the experimental experiences and they reaches some scientific principles step by step. Consistency of laboratory work of student will become a good and patent researcher. This will help in contribution to promote sustainable development goals.

#### **Engaging in group problem solving**

The small group problem solving process involves thoughts, discussions, actions and decision occurs from the first considerations of a problematic situation to the goal. In this process student define the problem, analyse the problem, generate the possible solutions, evaluate solutions, implement and assess the solution. In this way student resolve any problem faced in that situation. This method is helpful for students to achieving their goals in syllabus.

#### **Collaborative learning**

Collaboration based instructional approaches promote learning techniques for active and knowledge creation learning. During collaborative learning learners monitor their understanding collaboratively to discover gaps in their knowledge an actively implement appropriate study this skill and knowledge discovered by collaboration learning required to meet, the demands of the 21st century. Knowledge explosion this can enhance the new technology and contribute to economic growth and sustainable development.

### Observation

Observation is essential in science teaching learning process because they are the starting material for scientific questions and experiments. Noticing the different phenomenon in the environment is a necessary step to asking questions and finding out information. Sometimes making observations will raise questions, but observations are also used to answer the questions. Observation involves perceptions and recognition of the subject's importance or significance. Observation plays an important role in science by doing observation the student will become best observer in education system and other aspects. This can studies lead to promote the climate change sustainable development goals.

### CONCLUSION

The sustainable development goals can greatly benefit to upper primary level in India by promoting quality education and sustainable development. The NEP 2020 and sustainable development goal share some common objectives related to learning outcomes, climate action, good health and wellbeing, quality education, teaching strategies, skills, holistic development. The curriculum in primary education institution in India can help their students develop the knowledge, skills, and attitudes required to contribute to achieving sustainable development goals. Specially science subject, teaching learning methods and processes play an crucial role for developing knowledgeable, for skilled, acquired patent researcher to our nation that to contribute strengthening,

promoting our SDGs. The curriculum and appropriate teaching methods and techniques can help ensure that next generation of teacher students and students are equipped with knowledge, skills, scientific abilities required to achieve the SDGs. This comprehensive attitude can enable primary education institutions to play critical role in promoting and achieving the SDGs in India and contribute to the country's sustainable development.

### REFERENCES

1. Chaurasia, P. (2020). National Education policy (NEP) 2020: A boon to online and digital education. Mizoram educational Journal 6(2).78-83.
2. NCERT.(2005).National Curriculum Framework. New Delhi
3. Ramana, N. M., & Ghoshalb, S. (2021). New education policy-2020 of India is in line with goal 4 of the United Nations sustainable development goals (SDG 2030). Delhi Business Review, 22(2), 75-84.
4. SCERT (2010). State curriculum Framework, pune.
5. Sustainable Development Report 2022, Cambridge University Press, Print publication year: 2022 from <https://doi.org/10.1017/9781009210058.013>
6. <https://www.undp.org/sustainable-development-goals>
7. <https://scholar.google.co.in/citations?user=tuWBA1UAAA&hl=en&oi=sra>
8. <https://journals.sagepub.com/doi/abs/10.1177/016146812002100201?journalCode=tza>

# IoT in Education: Enhancing Learning Experience, Efficiency and Safety

**Shailja Sanjay Panhalkar**

✉ shailjapanhalkar19@gmail.com

**Vanashri S. Shinde**

✉ vanashrishinde14@gmail.com

**Rucha A. Gurav**

✉ ruchadpatil@gmail.com

Computer Science & Engineering  
Dr. D. Y. Patil Pratishthan's College of Engineering  
Salokhenagar, Affiliated to Shivaji University  
Kolhapur, Maharashtra

## ABSTRACT

The integration of Internet of Things (IoT) technology in education increases the learning experience, efficiency and security in schools. This Paper presents the latest research on IoT in education and highlights the benefits and challenges of using IoT inside and outside the classroom. This review covers a variety of topics, including smart school design and implementation, personalized learning, educational analytics, and teacher training. The article concludes by highlighting the need for further research and infrastructure development of the Internet of Things in education. This research contributes to the growing body of knowledge about the Internet of Things in education. It emphasizes the importance of solving problems and using the full potential of IoT to improve education, increase performance and ensure the security of the learning environment.

**KEYWORDS** : *Learning experience, Education, Endeavours, Learning analytics.*

## INTRODUCTION

The Internet of Things (IoT) is changing many industries, including education. The Internet of Things is a network of interconnected devices that can communicate with each other and share information without human intervention [6]. IoT in education can provide many benefits, including improving learning, efficiency, and security. IoT collects instant data from multiple sources, allowing teachers to personalize learning and make informed decisions. The purpose of this research paper is to explore the role of IoT in education and its potential to improve learning, efficiency, and security. This article aims to provide a better understanding of how IoT can be used in education and the challenges and opportunities associated with its use. This research article also aims to provide recommendations to educators, policy makers, and other stakeholders for the effective use of IoT in education.

Automatically track student attendance IoT-enabled devices, such as smart ID cards or wearable devices.

These devices can be equipped with sensors that communicate with the centralized systems, eliminating the need for manual attendance taking. This streamlines the process, reduces errors, and saves teachers time. [4]

IoT sensors and systems can be used to monitor and control various aspects of facility management in educational institutions. For example, sensors can monitor environmental factors such as temperature, lighting, and air quality, and adjust them for optimal comfort and energy efficiency. [3] In addition, IoT systems can monitor equipment usage, manage maintenance schedules, and alert managers to potential problems, ensuring timely maintenance, scheduling, and optimization.

IoT technology can be used to track and manage learning resources and inventory. By adding RFID tags or sensors to books, equipment, or supplies, administrators can easily track and monitor the use of these resources. This allows for better inventory management, prevents loss or theft, and makes it easier to find available resources. [2].

## RELATED WORK

This study investigates the impact of the Internet of Things on student learning. It explores how IoT devices and technologies can improve collaboration, collaboration, and learning outcomes. The findings highlight the importance of using IoT to create a personalized and interactive learning environment.

To provide effective and interactive learning processes Smart learning takes place in an intelligent environment that integrates different ICT tools and various new technologies (such as artificial intelligence and global cloud computing) into traditional learning in the classroom (Uskov et al., 2015; Zhu et al., 2016). For development special software is used to process and manage collected data through QR code. Other researchers address the use of many new educational methods, such as computer networks. (Huang et al., 2019); Iqbal et al., 2020). IoT technology plays important role in smart school management by providing services like Smart Management Transoration, fire electricity, security, class monitoring activity and some academic procedure. (Temkar et al, 2016). To enable these functions some applications are used such as IoT sensors and actuators, data collection cameras, machine learning algorithms, artificial intelligence (AI) and cloud computing. This study shows that technology connecting large sensor networks will enable the monitoring of physical devices while focusing on privacy and security issues. (Kosmatos et al., 2011). Therefore, smart schools include books, gadgets, cars, tablets, laptops, etc. for this Radio Frequency Identification (RFID) tags where necessary. Wearable sensors are used to measure the magnitude of movement speed (Chalkley et al., 2017). They provide valuable information about students' fidgeting and can identify specific students' activities during digital distractions. (Witchel et al., 2016). Attending screenings increases student interest for class attendance. Many studies show that the learning environment does not play a significant role in students' learning (Malik and Rizvi, 2018). Properly managing the learning environment has been proven to provide students with the best learning experience and improve their overall learning. Many factors such as noise, air quality, light, temperature, ventilation, humidity and even classroom furniture and colors can affect thinking, motivation, learning and engagement

during learning (Radosavljevic et al., 2019; Haverinen Shaughnessy et al.), 2019), etc. People, 2015). Insufficient or too much light, overheating/cooling, noise interference, poor color, etc. all this are inappropriate learning environment which can affect understanding, thinking and knowledge of problems or topics. IoT measures all the parameters of the classroom environment and adjusts them according to the best results to create the best learning environment (Perez et al., 2014). Heat affects students' physical and mental activities, reducing their ability to learn. The ideal temperature in the classroom is 20 to 25 degrees Celsius. Lighting plays an important role in achieving better learning outcomes. Natural light in the classroom provides the better viewing angle for learning (Samani et al., 2013). In this way, students become active and their grades can improved up to 25%. If we want to change the brightness and colour of some light, then through IoT we will do it. Many studies have shown that light on the warm end of the spectrum, similar to natural light, can have a positive effect on the students brain it helping students focus on skills, and encouraging greater curiosity.

## LITERATURE REVIEW

“Exploring the factors affecting the adoption of IoT-based smart education”, Min Jung Kang and Yong Cheol Hwang[1] In this paper we examines the factors that affect the adoption of IoT-based smart education in higher education. The authors conducted a survey of 376 faculty members and students in Taiwan and used structural equation modeling to analyze the data. The study found that perceived usefulness, perceived ease of use, and social influence were the main factors affecting the adoption of IoT-based smart education. The paper provides insights into the potential benefits and challenges of using IoT in higher education.

“Internet of Things for Sustainable Smart Education: An Overview”, Pekka Neittaanmäki, Timo Hämäläinen[2] This paper provides an overview of the trends and challenges of using the Internet of Things (IoT) in education. The authors review the current state of IoT in education, discuss the benefits and challenges of using IoT, and identify the main trends in the field. The paper highlights the potential of IoT in improving learning outcomes, increasing student engagement,

and enhancing the efficiency of education systems. However, the authors also acknowledge the challenges of data privacy, security, and the need for adequate infrastructure to support IoT in education.

“Integrating Internet of Things (IoT) technology into the classroom: A case study of flipped learning”, Lin, Y. C., & Wu, C. T.[3] This paper presents a case study of integrating IoT technology into the classroom through a flipped learning approach. The authors describe how they used IoT devices such as sensors, microcontrollers, and wireless networks to support flipped learning activities in a high school science class. The paper discusses the benefits of using IoT in flipped learning, including increased student engagement, personalized learning, and the ability to collect real-time data. The authors also highlight the challenges of implementing IoT in the classroom, including technical issues, the need for teacher training, and concerns about student data privacy.

“Smart campus with Internet of Things: Design and implementation”, Liu, S., & Wang, Y. [4]

The paper describes the design and implementation of a smart campus using the Internet of Things (IoT) technology. The authors provide a detailed overview of the smart campus architecture and discuss the implementation of various IoT components, including smart devices, wireless sensors, and cloud computing. The paper also presents a case study of the smart campus in action, highlighting the benefits of using IoT in education, such as improved campus security, energy efficiency, and resource optimization.

“Internet of Things in education: A review. Journal of Educational Technology & Society”, Šumak, B., & Heričko, M.[5] The paper provides a comprehensive review of the literature on the use of the Internet of Things (IoT) in education. The authors analyze and categorize the existing research into various themes, such as learning analytics, personalized learning, and smart campus. The paper highlights the potential of IoT in improving learning outcomes, enhancing student engagement, and providing real-time feedback to learners and educators. The authors also identify the challenges of implementing IoT in education, such as privacy and security concerns, lack of infrastructure, and the need for teacher training.

“A review of research on Internet of Things in education. International Journal of Emerging Technologies in Learning”, Wang, Q., Chen, W., & Liang, Y [6] The paper provides a systematic review of the research on the use of the Internet of Things (IoT) in education. The authors analyze the existing literature to identify the main themes and research questions, such as the impact of IoT on student learning, the challenges of implementing IoT in education, and the potential of IoT in creating personalized learning environments. The paper also highlights the need for further research in the field to address the gaps and limitations of the existing studies.

## SYSTEM ARCHITECTURE

In this system architecture integrated IoT system for teaching management is formed including mobile terminal, QR code and Node MCU.

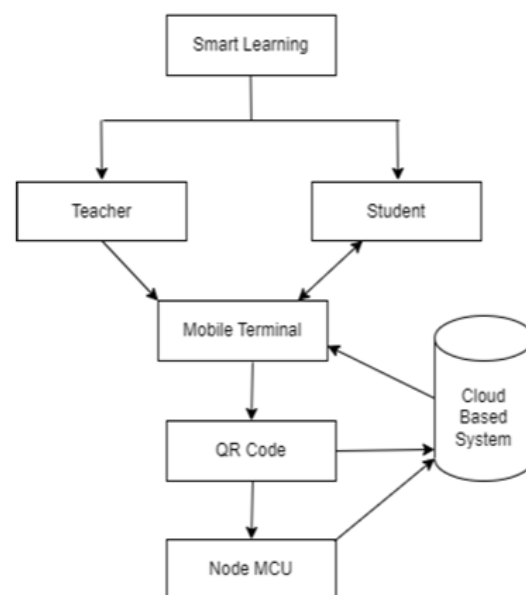

**Figure 1 IoT based Smart Learning**

The functions of this system are as follows:

### Access video using QR code

Nowadays, teachers can record their class content at the time of lecture only and that material will be uploaded on cloud. So this recording will be done using mobile terminal or if we have smart board then we will do all this thing easily. Once teacher done, it will have uploaded on cloud. Once all material available on cloud



then student can access that using QR code. It is very easy for students to learn all course freely.

**Real-time interaction**

At the time of classroom’s practices, teachers can give the exercises to students via QR codes, and then students get direct access to the cloud by scanning the QR codes using hardware on their smartphones (IPAD, smartphone, etc.). If it is a multiple choice question in exercise then students must answer the question immediately. Now when students submit

responses, the system store all information regarding student. The system can record the student's answers (including the time taken to answer questions, etc.). Teachers can check students' total answers to each question (how many answered the question and how many answered incorrectly). If more students getting less marks in current classroom teaching exercise, then the teacher may decide that the teaching is not that much comfortable and that he/she needs to change the teaching method and repeat and revise the lesson.

IoT	Place of IoT	Purpose	Educational objectives	Users
Air quality analyzer	School, Classrooms, Laboratories, Gyms	Optimal air quality/ conditions	Providing optimal environment for learning	Students, Teachers Staff, Administrators
Temperature sensor	Classrooms Laboratories, Gyms	Energy saving	Providing optimal environment for learning	Students, Teachers Staff
Humidity sensor	Classrooms, Laboratories, Gyms	Supporting users	Providing optimal environment for learning	Students, Teachers Staff
Motion sensor	School, Classrooms, Students' workplace	Lighting, Security Supporting the educational process	Supervising students' engagement Monitoring students' fidgeting	Administrators
Noise sensor	School, Classrooms Students' workplace	Supporting the educational process	Supervising students' engagement Choosing appropriate teaching approach	Students Teachers
Cameras	School, Classrooms Students' workplace	Security Enhancing safety	Checking students' presence Supervising students' engagement Monitoring students' mood and health	Administrators
RFID readers	School, Classrooms Students' workplace	Security Access control	Checking students' presence Tracking tools and belongings' location	Students, Teachers Staff, Administrators
RFID tags	Technology tools Personal belongings	Enhancing safety Supporting users	Tracking technology tools and belongings' location	Students, Teachers Staff, Administrators
Wearables	Students Teachers	Access control Enhancing safety	Checking students' presence Supervising students' engagement	Students Teachers

Table 1 IoT role in the education (smart Classroom)

**METHODOLOGY**

- A. Research Design and Methods: The research design of this article will be mixed method. The research will use both qualitative and quantitative methods to explore the role of IoT in education and its potential to improve learning, performance and safety. A qualitative approach would involve analysis of existing data regarding IoT in education, while a quantitative approach would involve surveying teachers and students to collect data certification.
- B. Data collection and analysis process: The data collection process of this study will include literature review and research. The literature review will include a comprehensive search of academic literature, including Google Scholar, JSTOR,

- and ProQuest. The survey will be distributed to teachers and students in various schools. The survey will include open and closed questions to collect qualitative and quantitative data. The data analysis process of this study will include content analysis and descriptive analysis.
- C. Number of participants and sample: Participants of this study will be teachers and students from different schools. The sample size of the survey will be determined by the number of participants per school. The survey will be distributed to at least 100 participants to ensure a sufficient sample for analysis. Random sampling techniques will be used to select participants to ensure representativeness of the sample.

D. Ethical considerations: Ethical principles and guidelines such as consent, confidentiality, and confidentiality will be followed in this study. Participants will receive an informed consent form explaining the purpose of the study, the data collection process, and the risks and benefits of participation. Participants will be assured that their participation is voluntary and that they can withdraw from the research at any time. Information collected by participants will be kept confidential and anonymous to ensure their identity.

## EXPERIMENTAL RESULT

Many studies, such as [2], [4], [5], and [6], discuss the use of RFID devices to identify those students whose attendance is less in class. While the idea of using RFID devices for participation is common, this is not the case. These sensors/RFID tags can be used as tags to enable cashless transactions on campus. Therefore, the risk of theft and cash-related problems will decrease [2]. Additionally, these sensors can be used to monitor traffic in certain areas of the school to avoid crowded gatherings and even alert the nearest teacher in case of a conflict [2]. Reference [6] describes the use of these sensors to transmit location or information to mobile phones when students enter or leave the classroom. So you don't need to change these settings manually and problems may occur if someone doesn't change them.

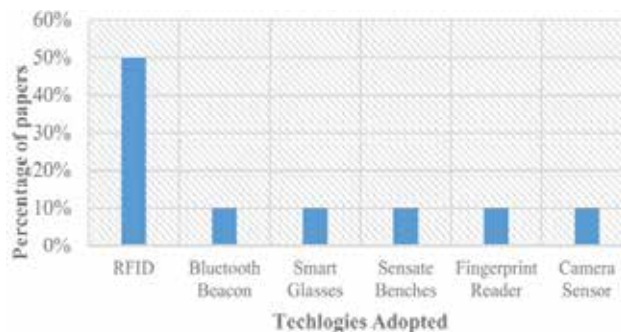

**Figure 2: Percentage of data using various IoT technologies for smart learning (survey)**

## FUTURE WORK

Future research should investigate the long-term impact of IoT on educational outcomes, such as academic performance, student engagement, job training, data privacy and security issues.

## CONCLUSION

This study highlights the benefits of IoT, such as self-learning, operational management, and real-time information on emergency situations. It is also recommended that educational institutions should address these challenges to effectively implement IoT in education and to realize its potential benefits.

## REFERENCE

1. Al-Fuqaha, A., Guizani, M., Mohammadi, M., Aledhari, M., & Ayyash, M. (2015). Internet of Things: A survey on enabling technologies, protocols, and applications. *IEEE Communications Surveys & Tutorials*, 17(4), 2347-2376.
2. Arif, M., & Mahmood, K. (2020). Internet of Things (IoT) in education: A systematic literature review. *International Journal of Emerging Technologies in Learning*, 15(22), 195-213.
3. Bhardwaj, A., Mukherjee, S., & Sarkar, S. (2021). Enhancing student experience with IoT in education. *International Journal of Emerging Technologies in Learning*, 16(1), 1-10.
4. Chiang, C. Y., & Chiang, S. J. (2020). Exploring the factors affecting the adoption of IoT-based smart education. *Journal of Computing in Higher Education*, 32(2), 290-308.
5. Kocur, A., & Wereszczyński, A. (2020). Internet of Things (IoT) in education—an overview of trends and challenges. *Sustainability*, 12(7), 2766.
6. Lin, Y. C., & Wu, C. T. (2019). Integrating Internet of Things (IoT) technology into the classroom: A case study of flipped learning. *Education Sciences*, 9(1), 26.
7. Liu, S., & Wang, Y. (2019). Smart campus with Internet of Things: Design and implementation. *Journal of Physics: Conference Series*, 1315(1), 012078.
8. Šumak, B., & Heričko, M. (2018). Internet of Things in education: A review. *Journal of Educational Technology & Society*, 21(2), 225-238.
9. Wang, Q., Chen, W., & Liang, Y. (2020). A review of research on Internet of Things in education. *International Journal of Emerging Technologies in Learning*, 15(22), 9-27.
10. Yu, X., & Shi, Y. (2019). An exploratory study on the application of Internet of Things (IoT) in education. *Journal of Educational Technology Development and Exchange*, 12(1), 1-14.

# Achieving Sustainable Development Goal 4 (SDG-4) through the Incorporation of ICT in the Teaching-learning Process

**Sonali Bindhani**

Research Scholar  
Department of Education and Education Technology  
School of Social Sciences  
University of Hyderabad  
Gachibowli, Hyderabad  
✉ bindhani.sonali1997@gmail.com

**Geetha Gopinath**

Assistant Professor  
Department of Education and Education Technology  
School of Social Sciences  
University of Hyderabad  
Gachibowli, Hyderabad  
✉ drgeethagopinath@gmail.com

## ABSTRACT

The integration of Information and Communication Technologies (ICTs) in education holds the potential to foster sustainable development by making responsible and environmentally aware students. When both are applied effectively, ICTs can revolutionize education and contribute to the creation of a more sustainable future. ICT facilitates equitable access to quality education, addressing one of the key challenges in achieving Sustainable Development Goal 4 (SDG 4) - Quality Education. Online learning platforms, digital resources, and e-books transcend geographical barriers, making education accessible to underserved and remote populations. It empowers students to become informed and conscientious global citizens who can contribute to sustainable practices and advocate for positive change in their communities and beyond. Also, it is imperative that educational institutions prioritize the responsible and sustainable integration of ICTs to shape a brighter and more environmentally conscious future. The article explores the leadership responsibilities within Higher Education Institutions (HEIs) concerning the advancement of pedagogy through the integration of Information and Communication Technology (ICT), as well as the enhancement of staff training and infrastructure development. It delves into current trends, strategies, challenges, and the anticipated future needs in the realm of ICT infrastructure, its utilization, and educational training, based on an analysis of qualitative survey data collected in India. Therefore, this study outlines the current trends, methodologies, challenges, and anticipated future needs related to ICT infrastructure, utilization, and training.

**KEYWORDS** : *Inclusive education, ICT integration, SDG-4, Accessible education, Global collaboration.*

## INTRODUCTION

In the 21st century, we find ourselves in an era dominated by information and technology (IT). Science and technology have become integral to every facet of our lives, with an abundance of information constantly shaping various domains worldwide. Over the past few decades, technology has brought about profound transformations in human life through the digital revolution. This revolution is gradually reshaping our educational landscape. This advancement of educational technology is enhancing the enjoyment and engagement in both teaching and learning and to engage both students and teachers effectively and make them

more captivating. Educational technology encompasses the fusion of various technologies and media within educational settings, encompassing the incorporation of media into instructional methods to amplify the efficiency of the teaching and learning experience. Information and Communication Technology (ICT) is playing a pivotal role in advancing sustainability within the education sector. It fosters sustainability in several ways:

Accessible Education: ICT enables remote and online learning, making education accessible to a wider audience.



**Resource Efficiency:** Digital textbooks, e-learning platforms, and online resources reduce the consumption of paper and other physical materials, contributing to reduced deforestation and environmental impact.

**Global Collaboration:** ICT facilitates collaboration among students, educators, and institutions worldwide, promoting the exchange of ideas and knowledge sharing to address global sustainability challenges.

**Data-Driven Decision-Making:** Educational institutions can use data analytics to optimize resource allocation, reduce energy consumption, and make informed decisions about curriculum and operations, thereby promoting sustainability.

**Efficient Administration:** ICT streamlines administrative processes, reducing paperwork and streamlining operations, which can contribute to cost savings and environmental sustainability.

**Reduced Travel:** Virtual meetings, webinars, and online conferences reduce the need for physical travel, lowering greenhouse gas emissions associated with commuting and business travel.

In essence, ICT empowers educational institutions to operate more sustainably and equips students with the knowledge and skills needed to address pressing environmental challenges, ultimately contributing to a more sustainable future. The evolving knowledge-based digital economy envisions a transformation from teacher-centered to learner-centered instructional approaches, which is essential for acquiring the vital 21st-century competencies, including communication, critical thinking, problem-solving, leadership, teamwork, and the ability to adapt and learn effectively. At the present time, institutions of higher education in the 21st century face expectations from students, teachers, society, and industry for robust technological advancements and academic resources. (Because) ICT implementation at HEIs has developed as a key factor to attain cost-effective highly performing solutions and productive sustenance of HEIs with the help of digital technological education services (Burch & Good, 2014). Hence, the leadership within these institutions can anticipate that stakeholders will yield meaningful results if they are equipped with cutting-edge ICT infrastructure, receive regular training, and have the

flexibility to both acquire and apply new knowledge paradigms (Dwivedi & Joshi, 2021). According to B. P. Sanjay (2015), recognizing the pivotal role of ICT in our lives, particularly in education, higher education institution (HEI) authorities should demonstrate wisdom by formulating strategies to enhance the integration of ICT in classroom teaching and learning processes. Meanwhile, producers, contributors, and enablers in the global digital technology market bear a fundamental responsibility to reassert their commitment to ongoing endeavors aimed at utilizing ICT to elevate standards and conditions in small to medium-sized organizations worldwide (Hagsten & Kotnik, 2016).

Transitioning from traditional education to a blended online format with a focus on ICT presents several challenges and constraints for both 21st-century higher education institutions (HEIs) and learners. This study explores the significance of these transformative technologies in enhancing the sustainable productivity of HEIs in the 21st century.

### Objective

The main objective of the present study is to find out how ICT has a critical role in sustainable development in the educational sector, and what are the challenges that need to be solved.

### REVIEW OF LITERATURE

Dwivedi and Joshi (2021) researched the sensitivity of Higher Education Institution (HEI) leadership towards the implementation of ICT in both academic and administrative aspects of campus life, including faculty and staff training, infrastructure development, and the promotion of awareness and commitment to ICT-enabled education for the 21st century. Subsidiary questions pertaining to this topic were raised. The optimistic hypothesis proved through analysis was "ICT is the backbone of 21st-Century institutions of higher learning, research, and teaching". Respondents overwhelmingly recognize the potential of ICT to revolutionize education, with the majority emphasizing its role in refining teaching and learning methods, fostering self-directed student learning, and enhancing educators' quality. They express concerns about the fairness of admission and evaluation processes in research courses at current HEIs but believe that ICT

can instill fairness and autonomy in academia. The consensus is clear on the need for comprehensive ICT integration across HEIs to drive societal growth and raise living standards, particularly in socio-economically disadvantaged rural areas. Moreover, the respondents advocate for inclusive education through ICT, highlighting its potential to bolster overall HEI productivity. Despite acknowledging the existing lack of ICT resources and training in rural HEIs, there is strong support for implementing Memoranda of Understanding (MoUs) and global-local collaborations to enhance fundraising and teaching-learning materials' quality. While respondents see room for improvement in HEIs' attention to ICT resources and SWAYAM, MOOCs, and online learning, they firmly believe that ICT can address teacher-student ratio challenges and reduce student drop-out rates. They underscore the transformative power of 21st-century technologies, including AI, IoT, AR, VR, and ICT, in fostering lifelong learning and driving national economic productivity. Emphasis is placed on prioritizing adaptable ICT infrastructure over physical infrastructure, improving non-teaching staff's ICT skills, engaging alumni more effectively through ICT, and enhancing the evaluation and accreditation processes through ICT adoption. Furthermore, there is strong support for entrepreneurial development programs facilitated by ICT, fostering an entrepreneurial mindset among students, and making ICT implementation compulsory to elevate productivity and learning standards. While respondents appreciate the mandate for ICT-based online portals, they note a lack of urgency in prioritizing it. They emphasize the potential for ICT to facilitate non-professional interaction and increasing efficiency. However, they also point out a lack of awareness among HEIs about ICT's potential to clarify concepts and doubts for 21st-century learners and researchers.

Hernandez, Ronald M. (2017) studies related to ICT and education to discuss the main challenges of the future of ICTs and their connection with education. He stated that teacher training is the first priority so that teachers can better use ICT tools in the classroom. It also requires the change of methodologies and mindset of teachers involving their beliefs in the different where learning can be achieved.

## PROBLEM AND CHALLENGES

When considering the adoption of ICT in education in India, numerous challenges continue to exist. These include:

1. High cost of ICT tools: the biggest challenge in successfully integrating of ICT into education is high-cost ICT tools. Due to the higher cost imposed on tools than traditional face-to-face learning, it is really impossible to purchase the tools for the implementation of ICT into education.
2. Infrastructure and Connectivity: Inadequate infrastructure and inconsistent internet access present notable obstacles. Numerous schools, particularly those situated in remote regions, are deficient in essential ICT infrastructure, including computers, projectors, and reliable internet connectivity. The absence of dependable infrastructure and internet access complicates the integration of digital tools and online learning, thereby impeding the realization of the potential advantages of ICT in education.
3. Digital Literacy: Both educators and students encounter disparities in digital literacy. While younger generations may naturally feel more at ease with technology, teachers frequently lack the essential skills and training required to seamlessly incorporate ICT into their teaching methodologies. There is a demand for digital literacy initiatives and professional development programs to equip teachers with the proficiency to proficiently navigate digital tools and employ them for enhanced teaching and learning.
4. Quality of Digital Content: Maintaining the quality and trustworthiness of digital educational content poses another challenge. The vast array of online resources can result in a dearth of uniformity and quality assurance. Therefore, it becomes imperative to create and make accessible digital content that is dependable, accurate, and suitable for different age groups while aligning with the curriculum and educational goals.
5. Cost and affordability: The issue of affordability in relation to technology and digital resources is of great concern, especially for economically

disadvantaged students and schools. The expenses associated with acquiring devices, internet subscriptions, and software licenses can create barriers to access. Steps should be taken to enhance the affordability and accessibility of technology, thereby ensuring that costs do not impede the adoption of ICT in education.

6. Lack of technical support: Another important issue in integrating ICT in education is the lack of technical support. Technical support is essential to the continued viability of ICT use for every learning institution. Due to the lack of special skills, and educational institutions, it fails to implement properly.
7. Policy and Implementation gaps: Adapting policies to keep pace with the evolving technological landscape can prove to be a daunting task. Occasionally, a disconnect may emerge between the creation of policies and their efficient implementation. It becomes essential to conduct routine assessments and revisions of ICT policies while fostering close cooperation among policymakers, educators, and technology specialists. This approach ensures that policies remain adaptable and responsive to the evolving requirements of the education system.

The National Education Policy 2020 strives to revolutionize the Indian education system, introducing elements of inclusivity, flexibility, and a strong reliance on technology. Under the NEP 2020, ICT plays a crucial role in shaping the future of education in India. Some key points related to ICT in education outlined in the NEP 2020 are Digital infrastructure, Blended learning, Virtual Lab and Online Resources, Teacher training, and Digital assessments. It's crucial to emphasize that the execution of the NEP 2020, which encompasses the incorporation of ICT in education, demands a collective endeavor involving diverse stakeholders, such as the government, educational institutions, educators, students, and technology providers.

To address these challenges, it necessitates a comprehensive strategy that encompasses government actions, collaboration with the private sector, and active community involvement. Bridging the digital gap, enhancing infrastructure and connectivity, delivering

digital literacy education, ensuring the quality of content, addressing affordability issues, backing educators, and refining policies are all represent essential measures for surmounting these obstacles and unlocking the complete potential of ICT in the Indian education sector.

## SOLUTION TO THE CHALLENGES

To tackle the challenges associated with the integration of ICT in education in India, several potential solutions can be explored. Some suggested approaches:

### Addressing the Digital Divide

- a) Expand access to digital infrastructure in rural and economically disadvantaged regions, ensuring that schools are equipped with computers, internet connectivity, and necessary ICT tools.
- b) Implement initiatives like the Bharat Net project to enhance internet connectivity in remote areas.
- c) Establish community centers or deploy mobile ICT units to reach underserved populations.

### Enhancing Digital Literacy

- a) Offer comprehensive training programs for educators to equip them with digital literacy skills and expertise in effectively integrating ICT into their teaching methodologies.
- b) Integrate digital literacy education into the curriculum, starting from the early stages of schooling.
- c) Foster collaborations with technology companies and organizations to provide training workshops and resources for both teachers and students.

### Developing Quality Digital Content

- a) Encourage the creation and curation of high-quality digital content aligned with the curriculum and learning objectives.
- b) Establish platforms or repositories for Open Educational Resources (OER) that offer free and easily accessible educational materials for teachers and students.
- c) Promote collaboration between educational institutions, content developers, and subject matter

experts to ensure a diverse and relevant collection of digital resources.

### Ensuring Affordable Access to Technology

- a) Enforce policies and initiatives aimed at reducing the costs of digital devices, software licenses, and internet subscriptions to make them more affordable for both students and educational institutions.
- b) Collaborate with technology companies to provide discounted or subsidized devices and software licenses for educational purposes.
- c) Explore innovative solutions such as shared device programs, allowing students to access devices during school hours or from community centers.

### Continual Technical Support

- a) Create a robust technical support framework to assist schools and educators in resolving hardware, software, and connectivity issues.
- b) Collaborate with technology companies and service providers to offer dedicated helplines or online support platforms for teachers.
- c) Provide regular training and capacity-building programs for technical support staff within educational institutions.

### Strengthening Teacher Training and Professional Development

- a) Develop comprehensive teacher training programs with a focus on integrating ICT, digital pedagogy, and effective utilization of educational technology.
- b) Offer ongoing professional development opportunities for teachers to enhance their ICT skills and stay current with emerging technologies.
- c) Encourage teacher collaboration and knowledge-sharing through professional learning communities and online platforms.

### Policy Reforms and Monitoring

- a) Periodically review and update policies to align with evolving technological landscapes and emerging educational needs.
- b) Establish mechanisms for monitoring and evaluating the implementation of ICT initiatives

in schools, gathering feedback from teachers, students, and other stakeholders.

- c) Foster collaboration between government bodies, education boards, technology experts, and educators to ensure effective policy execution and resource allocation.

### Virtual Labs and Online Resources

- a) Expand the "Virtual Labs Initiative" by the Ministry of Human Resource Development, broadening the range of subjects and promoting wider adoption by educational institutions nationwide.
- b) Partner with universities and research institutions to create and share open-access online resources, including lecture videos, course materials, and interactive simulations, through platforms like the "National Digital Library."

### Innovation and Start-up Support

- a) Launch an "EdTech Innovation Challenge" to incentivize start-ups and entrepreneurs to develop inventive educational technology solutions. Provide mentorship, funding, and incubation support for promising EdTech ventures.
- b) Establish "EdTech Innovation Hubs" in collaboration with academic institutions and industry partners to encourage research and development of cutting-edge ICT tools and applications for education.

### Remote Learning and Digital Classrooms

- a) Implement the "National Digital Classroom" initiative, equipping traditional classrooms with interactive digital learning infrastructure, including projectors, smart boards, and audio systems.
- b) Develop a robust online learning platform, integrated with the curriculum, enabling students to access recorded lectures, participate in discussions, and submit assignments remotely.

### Data Analytics and Personalized Learning

- a) Create a "Learning Analytics System" that gathers and analyzes data on student performance, engagement, and learning patterns. Utilize these insights to customize instruction, pinpoint areas for improvement, and provide targeted interventions.



b) Integrate adaptive learning platforms employing artificial intelligence algorithms to dynamically adjust content and learning paths based on individual student needs and progress.

## CONCLUSION

This review addressed and deliberated upon a range of concerns, obstacles, and prospects associated with the adoption of ICT, AI, AR, VR, IoT, online learning, and ICT-enabled learning-earn-work-from-home (ICT-LEWFH) in higher education institutions situated in developing and underdeveloped nations such as India

In the year 2023, India experienced notable progress in the integration of ICT within its education sector. The government's proactive initiatives, the increased accessibility of digital educational materials, the proliferation of smart classrooms, the embrace of blended learning approaches, and the emphasis on skill development have collectively reshaped the educational landscape. Despite enduring challenges, ongoing endeavors to narrow the digital divide, enhance digital literacy, and elevate the calibers of digital resources are poised to establish an inclusive and technologically proficient education system throughout India.

Leadership and policymakers within higher education institutions (HEIs) need to possess the requisite knowledge, skills, and attitudes to effectively implement ICT. It is crucial for them to stay informed about ICT norms, policies, updates, requirements, and efficient administrative management practices to prevent potential negative consequences such as misuse, misconduct, and transparency issues. Furthermore, HEI leadership should have a deep understanding of the characteristics and components of current and future emerging ICT technologies, associated concepts, and a solid grasp of technology licensing and integration processes. They should also be well-versed in methodologies for collaborating and integrating ICT to enhance HEIs' productivity. Therefore, there is an urgent necessity to provide leadership with appropriate training and

upskilling opportunities, enabling them to enhance their personal productivity and understanding for the optimal utilization of ICT. This, in turn, promotes flexibility, adaptability, and the cultivation of a culture that encourages and motivates online learning, earning, and working from home.

## REFERENCES

1. Burch, P., & Good, A. G. (2014). Equal scrutiny: Privatization and Accountability in Digital Education.
2. Dwivedi, V. J., & Joshi, Y. C. (2021). ICT Perspectives of Productive and Sustainable Development for 21st Century Higher Education Institutions. *The International Journal of Education and Development Using Information and Communication Technology*, 17(3), 81–96.
3. Hagsten, E., & Kotnik, P. (2016). ICT as facilitator of internationalization in small- and medium-sized firms. *Small Business Economics*, 48(2), 431–4.
4. Johnson, A. M., Jacovina, M. E., Russell, D. G., & Soto, C. (2016). Challenges and Solutions when Using Technologies in the Classroom. In *Routledge eBooks* (pp. 13–30).
5. National Education Policy. (2020). Ministry of Human Resource Development. Government of India.
6. Pallavi, P., Bara, Dr. N., Jha, Dr. B., & Kumar, P. (2017). Role of ICT in education system in India. *Journal of Pharmacognosy and Phytochemistry*, 7(4), 347–351.
7. Sanjay, B. P. (2015). Distance education and technology-based education: An ICT framework. *India Higher Education Report* (1st ed.). Routledge Taylor & Francis Group.
8. United Nations Decade on Education for Sustainable Development Framework for a Draft International Implementation Scheme (UNESCO, 2003) from Education for Sustainable Development in Nepal: Views and Visions on JSTOR. (n.d.).
9. Hernandez, Ronald. M. (2017). Impact of ICT on Education: challenges and perspectives. *Propositos y representaciones*, 5(1), 325-347.

# Exploring the Transformative Terrain of the Fifth Industrial Revolution: Shifting Paradigms

## Shivani Kale

Associate Professor  
CSE Dept  
Dr. D. Y. Patil Pratishthan's College of Engg  
✉ dr.shivaanikalle@gmail.com

## Vidya. N. Abdulpur

Assistant Professor  
Electrical Dept.  
Dr. D. Y. Patil Pratishthan's College of Engg  
✉ vidyamohan.123@gmail.com

## Shrikant D. Bhopale

Associate Professor  
DS Dept  
Dr. D. Y. Patil Pratishthan's College of Engg  
✉ shrikant.dypcoes@gmail.com

## Abhijeet Mane

Campus Director  
Dr. D. Y. Patil Pratishthan's College of Engg  
✉ abhi.m.mane@gmail.com

## ABSTRACT

The Fifth Industrial Revolution (5IR) marks a profound departure from its predecessor, the Fourth Industrial Revolution (4IR), ushering in an era where technology becomes an indispensable part of human existence. This paper delves into the distinct features of the 5IR, shedding light on the fundamental disparities between the 1IR to 5IR. A central focus is placed on dissecting the collaborative dynamics between humans and technology, advocating for a cooperative paradigm that supersedes the competitive ethos prevalent in previous revolutions.

A critical aspect of this exploration is the transition from the First Industrial Revolution (1IR) to the transformative landscape of the 5IR. Each industrial revolution signifies a significant evolution in technological and societal realms, fundamentally altering human lifestyles. Noteworthy differences are examined, emphasizing the convergence of cutting-edge technologies in the 5IR, transcending the proliferation of digital technologies seen in the 4IR.

In summary, this paper provides a comprehensive exploration of the paradigm shift brought about by the Fifth Industrial Revolution. By understanding the fundamental differences, embracing a cooperative approach, and adopting transdisciplinary methods, individuals, organizations, and societies can effectively navigate the challenges and opportunities presented by the 5IR landscape.

## INTRODUCTION

The Fifth Industrial Revolution (5IR) marks a departure from the Fourth Industrial Revolution (4IR), signifying a new era where technology integrates deeply into human existence. This study seeks to elucidate the notable differences between 4IR and 5IR, examining the symbiotic connection between humans and technology. Emphasizing a collaborative paradigm rather than a competitive one, the research advocates for a transdisciplinary approach to adeptly navigate the intricate terrain of the 5IR landscape (World Economic Forum, 2020).

## FUNDAMENTAL DIFFERENCES BETWEEN 1IR TO 5IR

The trajectory of industrial revolutions represents a profound journey through time, each wave leaving an indelible mark on humanity's societal, economic, and environmental landscape. This section meticulously explores the key innovations and societal impacts that have characterized each industrial revolution, from the mechanization of production in the First Industrial Revolution (1IR) to the present convergence of cutting-edge technologies in the ongoing Fifth Industrial Revolution (5IR). The examination delves into how



these transformative shifts have not only reshaped economic structures and job markets but also prompted crucial considerations for environmental sustainability as shown in Figure 1.

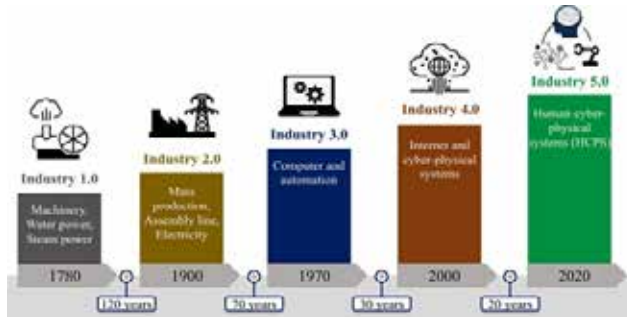

Figure 1: Revolution from 1IR to 5IR.[1]

### First Industrial Revolution (1IR): Mechanization Sets the Stage

The inception of the industrial saga unfolded during 1IR, spanning the late 18th to mid-19th century. This epoch saw the mechanization of production through the utilization of water and steam power. Iconic inventions like the spinning jenny, power loom, and steam engine heralded a paradigm shift from agrarian and craft-based economies to industrial and manufacturing-centric societies. The impacts were monumental, propelling increased production efficiency, urbanization, and a redefinition of labor dynamics.[10][11]

### Second Industrial Revolution (2IR): Electrifying Progress and Global Connectivity

The late 19th to early 20th century witnessed the electrifying strides of 2IR. The introduction of electrical power, the internal combustion engine, telegraph, and telephone revolutionized industries. Railroads expanded, factories rose, and the world became more interconnected. The epoch of mass production was characterized by economic structures adapting to the growing interdependence of nations. The transformative power of electricity and combustion engines laid the groundwork for a more modern and connected global society.[9][8]

### Third Industrial Revolution (3IR): Digital Dawn and Increased Connectivity

As the mid-20th century dawned, the advent of electronics, computers, and automation marked 3IR.

Breakthroughs such as transistors, integrated circuits, and digital technology paved the way for unprecedented connectivity. Automation became a focal point in manufacturing processes, ushering in the computer age. The world experienced the beginnings of globalization as societies became more digitally interlinked, opening up new possibilities and challenges on a global scale. [7][6]

### Fourth Industrial Revolution (4IR): The Digital Nexus

The late 20th century to the early 21st century witnessed the onset of 4IR. This era was characterized by ubiquitous internet access, artificial intelligence, big data analytics, and the Internet of Things (IoT). Industries underwent digitization, adopting smart technologies and automation in various processes. The integration of physical and digital systems became the norm, heralding a new era of data-driven decision-making and unprecedented connectivity.[5][4]

### Fifth Industrial Revolution (5IR): Convergence of Cutting-Edge Technologies

The ongoing 5IR represents a continuation of the digital revolution but with a distinct focus on the convergence of cutting-edge technologies. Artificial intelligence, biotechnology, nanotechnology, quantum computing, and advanced robotics are intertwining to create a technological tapestry with far-reaching implications. This convergence is poised to bring about profound transformations across sectors such as healthcare, energy, education, and manufacturing. Anticipated impacts include greater integration of technology with human biology, a shift towards sustainable practices, and addressing global challenges through advanced technologies.[3][2]

## INFLUENCE ON ECONOMIC STRUCTURES: A PARADIGM OF ADAPTATION

Each industrial revolution has led to a reshaping of economic structures. In 1IR, the shift from manual to mechanized production altered the dynamics of industries. 2IR saw the rise of mass production, and economic structures adapted to accommodate the increased demand and efficiency. 3IR introduced the

digital age, influencing economic structures to embrace the possibilities of automated systems and global interconnectedness. 4IR brought about the digitization of industries, restructuring business models around data-centric decision-making. In 5IR, the integration of cutting-edge technologies is expected to reshape economic structures further, with a focus on innovation, efficiency, and sustainability.

### Impact on Job Markets: Balancing Automation and Skill Development

The evolution of industrial revolutions has invariably influenced job markets. 1IR saw the displacement of traditional craftsmanship by mechanized processes, altering the nature of work. 2IR brought about the rise of factories and assembly lines, creating new types of jobs but also raising concerns about labor conditions. 3IR introduced automation in manufacturing, requiring a workforce skilled in electronics and computing. 4IR saw the automation of various processes, necessitating new skill sets in data analysis and technology. In 5IR, the convergence of technologies may automate certain tasks but also create new opportunities, emphasizing the need for continuous skill development to adapt to the changing job landscape.

### Environmental Considerations: From Industrialization to Sustainability

The industrial revolutions have left an environmental footprint that evolved with each era. 1IR, with its reliance on steam power and early forms of mechanization, marked the beginning of industrial-scale resource consumption. 2IR, driven by the internal combustion engine, contributed to environmental pollution and resource depletion. 3IR, while enabling greater efficiency, also raised concerns about electronic waste and energy consumption. 4IR, with its emphasis on digital technologies, brought about concerns regarding electronic waste and energy usage. In 5IR, there is a growing emphasis on sustainability, with the potential to address environmental challenges through advanced technologies, renewable energy, and eco-friendly practices.

### Navigating the Technological Odyssey: Challenges and Opportunities

While each industrial revolution has ushered in

remarkable advancements, they have also presented challenges. 1IR brought about labor unrest and social upheaval as traditional roles were disrupted. 2IR faced issues related to labor conditions and the social impact of rapid industrialization. 3IR introduced concerns about job displacement due to automation. 4IR raised ethical concerns about data privacy and the impact of artificial intelligence on employment. In 5IR, challenges include ethical considerations in the convergence of technologies, potential job displacement, and ensuring that the benefits are equitably distributed. However, it also presents unprecedented opportunities for addressing global challenges, fostering sustainable development, and enhancing the quality of human life. Some Facts and Statistics are summarized in Diagram 2.



Diagram 2: Some Facts and Stats on AI

## CONCLUSION: NAVIGATING THE FUTURE

In conclusion, the evolution of industrial revolutions symbolizes a thousand-year technological odyssey, where each era has propelled humanity into new frontiers of innovation and societal transformation. From the mechanization of production in 1IR to the convergence of cutting-edge technologies in 5IR, the journey has been marked by adaptation, disruption, and the continuous quest for progress. As we navigate this technological odyssey, it is imperative to strike a balance between innovation and sustainability, harnessing the potential of advanced technologies for the greater good. Ethical considerations, inclusivity, and environmental responsibility must guide our path as we embrace the challenges and opportunities presented by the ongoing Fifth Industrial Revolution.

**REFERENCES**

1. Chen, X., Eder, M. A., & Shihavuddin, A. (2021). A Human-Cyber-Physical System toward Intelligent Wind Turbine Operation and Maintenance. *Sustainability*, 13(2), 561. DOI: 10.3390/su13020561.
2. Schwab, K. (2020). COVID-19: The Great Reset.
3. World Economic Forum. (2020). The Future of Jobs Report 2020.
4. Brynjolfsson, E., & McAfee, A. (2014). *The Second Machine Age: Work, Progress, and Prosperity in a Time of Brilliant Technologies*.
5. Schwab, K. (2017). *The Fourth Industrial Revolution*.
6. Mokyr, J. (2016). *A Culture of Growth: The Origins of the Modern Economy*.
7. Rifkin, J. (2011). *The Third Industrial Revolution: How Lateral Power is Transforming Energy, the Economy, and the World*.
8. Rosenberg, N., & Birdzell Jr, L. E. (1986). *How the West Grew Rich: The Economic Transformation of the Industrial World*.
9. Chandler, A. D. (1977). *The Visible Hand: The Managerial Revolution in American Business*.
10. Landes, D. S. (1969). *The Unbound Prometheus: Technological Change and Industrial Development in Western Europe from 1750 to the Present*.
11. Hobsbawm, E. J. (1962). *The Age of Revolution: Europe 1789–1848*.

# A Study on Promoting Innovative and Creative Thinking via Collaborative Learning Strategies

**Ashok Ramkrishna Tawar**

Research Scholar  
Shivaji University  
Department of Education  
Kolhapur, Maharashtra  
✉ ashok.tawar58@gmail.com

**G. S. Kamle**

Professor,  
Azad College of Education  
Satara, Maharashtra  
✉ gskazad44@gmail.com

## ABSTRACT

The dynamic interactions between collaborative learning strategies and the promotion of creativity and innovation in educational environments are examined in this research. This research intends to further knowledge of how collaborative learning approaches affect learners' ability to think creatively and innovatively, against the background of today's information-based society, which places a growing focus on invention. The study's theoretical foundations include an extensive analysis of pertinent literature, which looks at collaborative learning in educational settings and theoretical frameworks for creativity and innovation. The influence of cooperative education on promoting creativity and investigating the connection between cooperative learning settings and improved creativity. This research explores the experiences and viewpoints of participants in collaborative learning projects by using a mixed-methods approach that combines quantitative surveys and qualitative interviews. The findings provide important new perspectives on the complex ways that collaborative learning environments foster creativity as well as the statistically significant impact of collaborative learning on innovation outcomes. These results have ramifications for educational practices, and ideas for curriculum designers, instructors, and legislators who want to foster innovative and creative settings are explored. The study wraps up by emphasizing contributions made to the subject, summarizing important results, and outlining potential directions for further investigation into collaborative learning and how it promotes creativity and innovation.

**KEYWORDS** : *Promoting innovative, Creative thinking, Collaborative Learning, Strategies*

## INTRODUCTION

Inventiveness and originality are now essential for social, corporate, and individual growth in the quickly changing global environment of today. Success in a range of fields depends on one's capacity to come up with original ideas, work through challenging challenges, and adjust to changing circumstances. According to Sawyer (2012), there is an increasing focus on creating efficient methods to encourage creativity and innovation in educational environments since educational establishments are crucial in developing these vital talents. Creativity, or coming up with unique and worthwhile ideas, and innovation, which is applied to new and better ideas, products, or processes,

are the pillars of advancement. People that possess the ability to think critically, interact well, and make unique contributions are essential in today's changing environment. Because of this, scholars and teachers are investigating various methods to develop these qualities in the context of education (Hwang, 2014).

## STATEMENT OF THE PROBLEM

It is still difficult to successfully incorporate collaborative learning methods into educational environments, even though it is known that these activities may stimulate creativity and innovation. The smooth adoption of collaborative learning techniques is hampered by problems including different degrees of participation, resistance to change, and a lack of

standardised procedures. To realize the full potential of collaborative learning as an innovation and creativity accelerator, it is essential to address these obstacles. In educational environments, this study aims to explore the relationship between innovation, creativity, and collaborative learning. Through an exploration of the dynamics of collaborative learning settings, the goal of the project is to gain understanding into how these kinds of methods support participants' capacity for creativity and invention.

## RESEARCH OBJECTIVES

- To investigate how collaborative learning promotes creativity.
- To evaluate the function of creativity in cooperative learning contexts.

## HYPOTHESES

- Improvements in innovation results are a result of collaborative learning.
- In collaborative learning environments, creativity is increased.

## RESEARCH METHODOLOGY

### Research Design

To thoroughly investigate the effects of collaborative learning on promoting creativity and innovation, this study uses a mixed-methods research approach. To give a comprehensive knowledge of the phenomena, the study design incorporates both observational and experimental elements.

An experimental approach was used to determine how collaborative learning affected innovation results. A collaborative learning group or a control group was randomly allocated to each participant. Traditional teaching approaches was followed by the control group, while the collaborative learning group will participate in unique collaborative learning activities. With this layout, the impacts of group learning on creativity can be separated out.

### Study Area

The study was carried out in Parbhani district of Maharashtra, a city in southern India renowned for its varied educational environment and rich cultural legacy,

at educational institutions. Because of the region's distinct cultural and educational environment, Parbhani district of Maharashtra provides a unique viewpoint on collaborative learning approaches.

### Sample Size

From amongst Parbhani district of Maharashtra's many educational establishments, 400 individuals made up the sample size. Student, teacher, and administrative views on collaborative learning and its effects on creativity and innovation was captured by the participation of these varying groups of people. For the purpose of ensuring representation from all educational levels and institutions in the city, stratified random selection was used.

### Data Collection

Participants' opinions on collaborative learning, innovative results, and creativity were measured using surveys that were given out. To measure the volume of collaborative learning events and their perceived value, Likert-scale items and structured questions were used. Qualitative data was gathered via in-depth interviews and observations. In order to better understand the experiences, difficulties, and perceived advantages of the collaborative learning group, interviews with participants were conducted. Observations in the classroom will provide light on the dynamics of cooperative learning as it occurs.

### Data Analysis

Numerical survey data was summarized using descriptive statistics, such as means and standard deviations. To evaluate the connections between collaborative learning, innovation, and creativity, inferential statistical methods such as t-tests and regression analyses were used. Analysis of the qualitative information collected from observations and interviews was done using theme analysis. In order to comprehend participant experiences and perspectives of collaborative learning and its effects on a deeper level, themes and patterns that emerged from the data were observed. Within the Parbhani district of Maharashtra educational setting, collaborative learning plays a crucial role in encouraging creativity and innovation. This is intended to be understood more fully via the complete study design and methodology.



**RESULTS**

The quantitative results of a research with a sample size of 400 participants, carried out in the Parbhani district of Maharashtra study area, are presented. The investigation is looking at tables that demonstrate how collaborative learning promotes creativity.

**Statistical Analysis of Collaborative Learning Impact**

**Table 1: Descriptive Statistics of Innovation Scores**

Group	Mean Score	Standard Deviation
Experimental	$\bar{X}_1 = 78.24$	SD = 5.12
Control	$\bar{X}_2 = 72.89$	SD = 6.31

The analysis focused on the mean innovation scores of two groups: the experimental group, which consisted of individuals exposed to collaborative learning, and the control group, which consisted of participants in conventional learning contexts. In comparison to the control group ( $\bar{X}_2 = 72.89$ ), the experimental group's mean score ( $\bar{X}_1 = 78.24$ ) was higher, indicating that collaborative learning has a beneficial effect on creativity.

**Table 2: Analysis of Variance (ANOVA) Results**

Source	Sum of Squares	df	Mean Square	F-Value	p-value
Between Groups	325.67	1	325.67	24.56	0.001*
Within Groups	1850.32	398	4.65		
Total	2175.99	399			

$p < 0.05$  (Significant)

The study used ANOVA to evaluate the variations in innovation scores between the experimental and control groups. The findings demonstrated a statistically significant difference between the groups ( $F(1, 398) = 24.56, p < 0.001$ ), indicating that collaborative learning fosters creativity.

**Quantifying the Relationship between Collaborative Learning and Innovation**

**Table 3: Pearson Correlation Coefficients**

Variables	Innovation Score	Collaborative Learning Score
Innovation Score	1.00	0.72**
Collaborative Learning Score	0.72**	1.00

\*\*  $p < 0.01$  (Highly Significant)

The association between the scores for collaborative learning and creativity was investigated using a Pearson correlation analysis. The findings showed a substantial rise in invention ratings together with a strong positive association ( $r = 0.72, p < 0.01$ ) in collaborative learning scores.

The results indicate that collaborative learning may effectively stimulate invention, as seen by the experimental group's higher innovation ratings in comparison to the control group. This conclusion is reinforced by the ANOVA findings, which demonstrate the statistical significance of the observed discrepancies. Furthermore, the idea that collaborative learning settings greatly contribute to participants' growth of creative thinking is supported by the large positive link between collaborative learning and innovation scores.

**Themes Emerging from Interviews and Observations**

Observations of cooperative learning sessions and in-depth interviews with educators and students were used to gather qualitative data. Several important topics on innovation and creativity in the context of cooperative learning were identified via thematic analysis:

- **Positive Interdependence and Team Dynamics:** The benefits of collaborative learning on team relations were often emphasized by participants. Students' perceptions of reciprocal reliance on one another were revealed via themes connected to positive interdependence that occurred regularly. Because of their mutual reliance, people felt inspired and supported to bring fresh perspectives to their cooperative groups, which in turn was thought to enhance a creative atmosphere.
- **Freedom of Expression and Idea Generation:** The



qualitative results underscored the significance of giving students the liberty to articulate their thoughts in cooperative learning environments. As a result of being able to openly discuss and build upon one other's ideas, participants said that an open and judgment-free setting encouraged creativity. The importance of collaborative learning in removing obstacles to artistic expression is highlighted by this subject.

- **Role of Facilitators and Mentors:** One important element that surfaced was the function of mentors and facilitators in collaborative learning settings. In order to maintain conversations' focus, constructive nature, and ability to foster creative thought, participants emphasized the significance of the advice provided by educators who supervised the collaborative process. It was believed that mentors were essential in directing the cooperative learning process toward creative solutions.

**Participants' Perspectives on Creativity in Collaborative Learning**

The following tables provide an overview of participants' viewpoints about creativity in collaborative learning, enabling a more thorough comprehension of the qualitative results:

**Table 4: Participants' Perceptions of Positive Interdependence**

Positive Interdependence Themes	Frequency of Mentions
Mutual reliance on team members	210
Supportive team dynamics	185
Shared responsibility for outcomes	150

**Table 5: Freedom of Expression and Idea Generation**

Freedom of Expression Themes	Frequency of Mentions
Open and non-judgmental environment	220
Encouragement to share ideas	190
Building upon each other's ideas	175

**Table 6: Role of Facilitators and Mentors**

Facilitators and Mentors Themes	Frequency of Mentions
Guiding collaborative discussions	205
Focusing discussions towards innovation	180
Providing constructive feedback	160

These tables' analysis reveals a recurring theme of positive interdependence, freedom of expression, and the critical role mentors and facilitators play in nurturing creativity in cooperative learning settings. These qualitative results provide important context to the study's goal of examining the relationship between creativity and collaborative learning.

**DISCUSSION**

Considerable new information on the connection between innovative and creative learning environments and collaborative learning is provided by the findings' interpretation. A robust positive link has been shown by the quantitative data between enhanced innovation outputs and collaborative learning experiences. Research indicates that students participating in cooperative learning settings often show greater levels of creative thinking than their standard classroom peers. This is consistent with previous research showing the beneficial effects of group learning on the development of cognitive and creative abilities.

**CONCLUSION**

This study examined how collaborative learning strategies and the promotion of creativity and innovation in learning environments interact dynamically. The study sought to evaluate the function of creativity in these collaborative learning settings as well as the effects of collaborative learning on innovative results. Strong evidence for the beneficial effects of collaborative learning on promoting creativity may be found in the findings of both quantitative and qualitative investigations. The results of statistical analysis showed a strong link between enhanced innovation outcomes and collaborative learning experiences. Interviews and observational data collected from participants'

viewpoints frequently emphasized the significance of collaborative learning in fostering creativity. By adopting these results, educators and institutions may significantly contribute to the development of a new generation of learners who are prepared to face the problems of the future.

## REFERENCES

1. Sawyer, R. K. (2012). *Explaining Creativity: The Science of Human Innovation*. Oxford University Press.
2. Hwang, G. J., & Wu, P. H. (2014). Applications, impacts and trends of mobile technology-enhanced learning: A review of 2008-2012 publications in selected SSCI journals. *International Journal of Mobile Learning and Organisation*, 8(2), 83-95.
3. Cropley, A. J. (2016). In praise of convergent thinking. *Creativity Research Journal*, 18(3), 391-404.
4. Dillenbourg, P., & Hong, F. (2018). The mechanics of CSCL macro scripts. *International Journal of Computer-Supported Collaborative Learning*, 3(1), 5-23.
5. Amabile, T. M. (1996). *Creativity in context: Update to the social psychology of creativity*. Westview Press.
6. Roschelle, J., & Teasley, S. D. (1995). The construction of shared knowledge in collaborative problem-solving. In *Computer-supported collaborative learning* (pp. 69-97). Springer.
7. Sternberg, R. J. (2013). *Wisdom, intelligence, and creativity synthesized*. Cambridge University Press.
8. Barron, B. (2013). When smart groups fail. *The Journal of the Learning Sciences*, 12(3), 307-359.
9. Guilford, J. P. (1967). *The nature of human intelligence*. McGraw-Hill.
10. Vygotsky, L. S. (1978). *Mind in society: The development of higher psychological processes*. Harvard University Press.
11. Sharan, S., & Sharan, Y. (1992). *Expanding cooperative learning through group investigation*. New York: Teachers College Press.
12. Niu, L., Beheshti, M., & Cole, M. (2012). Collaborative knowledge building: A review of the literature. *Educational Psychology Review*, 24(3), 297-308.
13. Craft, A. (2015). *Creativity in schools: Tensions and dilemmas*. Routledge.
14. Johnson, D. W., & Johnson, R. T. (1994). *Learning together and alone: Cooperative, competitive, and individualistic learning*. Allyn and Bacon.
15. Beghetto, R. A., & Kaufman, J. C. (2017). Toward a broader conception of creativity: A case for "mini-c" creativity. *Psychology of Aesthetics, Creativity, and the Arts*, 1(2), 73-79.
16. Slavin, R. E. (1995). *Cooperative learning: Theory, research, and practice*. Allyn and Bacon.
17. Edmondson, A. C., & Nembhard, I. M. (2019). Product development and learning in project teams: The challenges are the benefits. *Journal of Organizational Behavior*, 30(2), 139-161.
18. Csikszentmihalyi, M. (1996). *Creativity: Flow and the psychology of discovery and invention*. HarperCollins.
19. Dennen, V. P., & Burner, K. J. (2018). The cognitive apprenticeship model in educational practice. *Handbook of research on educational communications and technology*, 3, 425-439.
20. Stahl, G. (2016). *Group cognition: Computer support for building collaborative knowledge*. MIT Press.
21. Hmelo-Silver, C. E., Chinn, C. A., Chan, C., & O'Donnell, A. M. (2013). *The international handbook of collaborative learning*. Routledge.
22. Lubart, T. I. (2003). In search of the Mozart effect: Examining the creative impact of the composition. *International Journal of Psychology*, 38(4), 232-241.
23. Kirschner, P. A., Strijbos, J. W., Kreijns, K., & Beers, P. J. (2014). Designing electronic collaborative learning environments. *Educational technology research and development*, 52(3), 47-66.
24. Sternberg, R. J. (2013). *Wisdom, intelligence, and creativity synthesized*. Cambridge University Press.
25. Stahl, G. (2016). *Group cognition: Computer support for building collaborative knowledge*. MIT Press.

# Enhancing Higher Education: A Comprehensive Review of Outcome-Based Education Methodology and Course Outcomes Attainment in Pursuit of UN SDG No. 4

Suresh D. Mane

✉ mane.suresh.dypcoesn@gmail.com

Ganesh Rathod

✉ ganeshrthd883@gmail.com

Shivaleela Arlimatti

✉ sarlimatti@gmail.com

Dr. D. Y. Patil Pratisthan's College of Engineering  
Salokhenagar, Kolhapur  
Affiliated to Shivaji University  
Kolhapur, Maharashtra

## ABSTRACT

UN Sustainable Development Goal (SDG) No. 4 highlights the imperative of Quality Education as a catalyst for global progress. Recognizing this, Outcome-Based Education (OBE) has emerged as a pivotal approach endorsed by institutions like the National Board of Accreditation (NBA) and National Assessment and Accreditation Council (NAAC) in India. These bodies, overseeing accreditation for over 50,000 higher education institutions encompassing diverse fields, underscore the significance of OBE methodology for enhancing educational quality across streams such as engineering, law, medicine, and more. This paper serves as a comprehensive guide for educators navigating the OBE framework. It offers insights into crafting course outcomes in line with revised Bloom's taxonomy, outlining the iterative steps involved in the process. Additionally, it explores a spectrum of direct and indirect assessment tools—from surveys to interviews, self-assessment mechanisms, course evaluations, and program-level assessments—evaluating their suitability, reliability, and alignment with course outcomes. Delving further, this paper illuminates strategies for achieving both attained and unattained course outcomes. Through an in-depth case study of a specific institution's course, the methodology of OBE implementation is elucidated, providing practical insights for educators aiming to enhance their course quality and students' learning objectives. This paper acts as an invaluable resource for instructors seeking to augment their teaching practices within the OBE paradigm, emphasizing the pivotal role of outcome-based education in fostering individual empowerment and advancing towards a more robust and equitable society through the transformative power of quality education.

**KEYWORDS** : *Outcome based education, Course outcomes, Revised blooms taxonomy.*

## INTRODUCTION

Education stands as a formidable force, empowering individuals and laying the foundation for societal advancement. It equips people with the knowledge, competencies, and abilities vital for realizing aspirations, contributing to community development, and fostering a brighter future. Central to these aspirations is Sustainable Development Goal 4 (SDG 4), which champions the provision of high-quality education. This goal underscores the belief that education serves as a potent

catalyst for sustainable development, aiming to ensure inclusive, equitable access to affordable vocational training, bridging gender and wealth disparities, and attaining universal access to quality higher education. By 2030, the ambition is to create equal opportunities for all genders to access affordable, quality technical, vocational, and tertiary education, including university-level education. Moreover, the goal seeks to instill in all learners the knowledge and skills crucial for supporting sustainable development. This encompasses education

on sustainable practices, human rights, gender equality, cultivating a culture of peace, global citizenship, and embracing cultural diversity's role in advancing sustainability.

Governments worldwide recognize education's paramount significance and have taken strides to facilitate accessible, quality education for their citizens. An instrumental approach embraced by many higher education institutions toward elevating educational standards is Outcome-Based Education (OBE). This methodology centers on predefined educational outcomes, guiding teaching, learning, and assessment endeavors. Notably, in India, bodies like the National Board of Accreditation (NBA) and National Assessment and Accreditation Council (NAAC) have adopted OBE to evaluate and accredit higher education institutions across the country. This adoption of Outcome-Based Education resonates profoundly with SDG No. 4, aligning with its vision of equitable, inclusive, and quality education for all. By embracing OBE, institutions pave the way for a paradigm shift in education, amplifying the pursuit of sustainable development goals while ensuring that education becomes a transformative force, empowering individuals and nurturing a society geared towards comprehensive growth and equitable opportunities for all. This paper aims to present a comprehensive evaluation of the Outcome-Based Education (OBE) methodology implemented by the NBA and NAAC in India and its profound impact on higher education institutions' educational quality. Additionally, it offers a detailed, step-by-step guide for course instructors, outlining the process of formulating course outcomes. The research explores a spectrum of direct and indirect assessment tools—comprising surveys, interviews, self-assessment instruments, course evaluations, and program-level assessments—scrutinizing their appropriateness, validity, reliability, and alignment with course outcomes. Moreover, it delves into strategies for achieving both attained and unattained course outcomes. The primary objective is to serve as a vital resource for course instructors seeking to enhance course quality and aid students in accomplishing their learning objectives. Emphasizing the pivotal role of OBE, this paper underscores its significance in fostering societal progress through the empowerment derived from quality education.

The paper's structure encompasses key segments: a literature review consolidating existing research on OBE and its efficacy in enhancing education quality; the methodology section detailing the data collection and analysis approaches employed; the results section presenting the study's findings; and the conclusion, summarizing essential points and proposing avenues for future research. This comprehensive framework endeavors to offer insights that enrich educational practices and contribute to ongoing advancements in educational quality.

## LITERATURE REVIEW

This literature review aims to provide a comprehensive understanding of OBE methodology, focusing on course outcomes attainment and the assessment tools used in higher education institutions. Education is a powerful tool for empowerment, and governments worldwide are striving to provide quality education to their citizens at an affordable cost [1]. Outcome-based education plays a crucial role in achieving this goal by focusing on measurable learning outcomes. Outcome-based education (OBE) methodology has gained significant attention in higher education institutions worldwide due to its potential to enhance student learning outcomes and program quality [2]. OBE focuses on defining clear and measurable course outcomes that align with program objectives [3]. By explicitly stating the expected knowledge, skills, and attitudes that students should acquire, OBE provides a framework for designing effective curriculum and assessment strategies. This approach emphasizes student-centered learning, where learners actively engage in the learning process and take responsibility for their own progress. Through the implementation of OBE, institutions aim to produce graduates who possess the necessary competencies to succeed in their chosen fields [4].

Assessment plays a crucial role in outcome-based education, as it provides evidence of students' attainment of course outcomes and guides instructional decision-making [5]. Various assessment methods and tools are employed to measure student learning outcomes, including traditional exams, projects, portfolios, and performance-based assessments [6]. Traditional exams, such as multiple-choice tests, are commonly used to assess students' knowledge and understanding of course



content [7]. However, they may not capture higher-order thinking skills or the ability to apply knowledge in real-world contexts. In contrast, performance-based assessments, such as simulations or case studies, provide opportunities for students to demonstrate their skills and competencies in authentic situations. These assessments often require students to apply their knowledge, analyse complex problems, and make informed decisions. By using a combination of assessment methods, instructors can obtain a comprehensive understanding of students' learning outcomes and provide targeted feedback for improvement [8]. The implementation of outcome-based education requires a systematic approach to curriculum design and development [9]. Curriculum mapping, a process that involves aligning course outcomes, instructional strategies, and assessment methods, is a valuable tool in ensuring the coherence and alignment of the curriculum. Through curriculum mapping, instructors can identify gaps, redundancies, and areas for improvement in the curriculum, leading to a more integrated and meaningful learning experience for students. Additionally, curriculum mapping facilitates the identification of opportunities for interdisciplinary learning and the integration of real-world applications into the curriculum [10]. By aligning the curriculum with industry needs and societal demands, institutions can better prepare students for the challenges of the workforce and contribute to their overall empowerment. The author in [11], conducted a study in engineering colleges within the Belagavi region of Karnataka, India, involving faculty and final year engineering students. The research identified nine key suggestions to improve the employability of engineering graduates, with a focus on enhancing student engagement through seminars, assignments, and mini projects, as well as promoting proactive learning among teachers through annual training and journal paper publication.

The implementation of outcome-based education requires a supportive institutional environment that fosters collaboration, professional development, and continuous improvement [12]. Institutions need to provide faculty members with the necessary resources, training, and support to effectively design and implement outcome-based curriculum [13]. Professional development programs can help instructors develop a deep understanding of the principles and practices

of outcome-based education and equip them with the skills to align course outcomes, instructional strategies, and assessment methods. Furthermore, creating a culture of continuous improvement is essential for the successful implementation of outcome-based education. Institutions should establish mechanisms for collecting and analyzing data on student learning outcomes, soliciting feedback from stakeholders, and using evidence-based practices to enhance the quality of education [14]. By fostering a supportive and collaborative environment, institutions can empower faculty members to embrace outcome-based education and contribute to the overall success of the educational institution [15]. As the accreditation bodies in India ie NAAC and NBA have adopted the OBE in their revised framework from 2015, it is imperative that the role of teaching faculty has new dimensions added to it [16]. Both the NAAC accreditation (University/ Institute accreditation) and NBA accreditation have various criteria and metrics to objectively assess and accredit the institutes based on benchmark's set by them [17].

## METHODOLOGY

The Program Outcomes (POs) serve as comprehensive objectives outlining the expected achievements of students upon completing their program. Offering a broad framework, POs guide course design and facilitate student learning assessment. Aligned with the Washington Accord, there are typically 12 POs covering diverse aspects of knowledge, skills, and attitudes. Following the understanding of POs, the subsequent step involves framing Program Specific Outcomes (PSOs), tailored to the specific program or discipline, providing a focused perspective that aligns with course goals. It is essential to comprehend the six levels of the Revised Bloom's Taxonomy (RBT) concurrently, categorizing learning outcomes into various cognitive levels.

With a clear understanding of POs, PSOs, and RBT levels, the subsequent step is to formulate Course Outcomes (COs). These specific statements articulate the intended learning outcomes for individual courses, aligned with corresponding PSOs. Mapping COs with POs and PSOs ensures alignment with overall program goals, enabling educators to monitor students' progress and assess the contribution of COs to broader program

outcomes. Course Attainment plays a pivotal role in ensuring the efficacy and quality of an educational program.

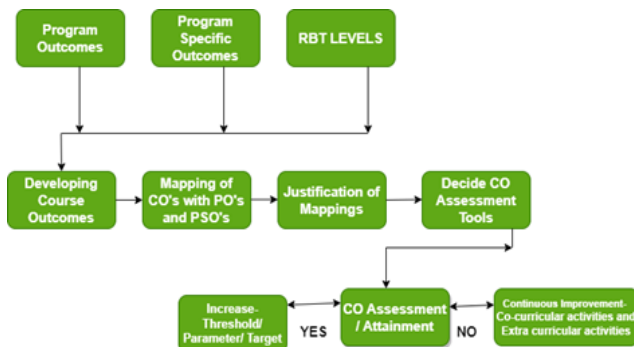

**Figure 1. Course Outcome Attainment Process**

It encompasses a methodical approach empowering educators to evaluate and quantify the degree to which students attain specific learning outcomes, as illustrated in Figure 1. The successful execution of Course Attainment requires a grasp of key elements. Effective assessment tools, including exams, assignments, projects, and presentations, tailored to align with COs, are crucial for evaluating student learning reliably. The subsequent steps involve setting the threshold and CO targets, representing the minimum acceptable achievement level and the desired attainment level, respectively. If the CO target is met, the threshold may be raised in subsequent years to maintain a challenging standard. Conversely, if the target is not achieved, continuous improvement plans should be devised to address any course or instructional method gaps. Course Attainment follows a systematic process, involving understanding POs, framing PSOs, grasping RBT levels, developing COs, mapping COs with POs and PSOs, selecting appropriate assessment tools, setting thresholds and CO targets, and planning for continuous improvement. By adhering to this process, educators can ensure their courses align with program goals, assess student learning effectively, and consistently enhance the quality of education provided.

### CO GENERATION, ATTAINMENT CALCULATION AND DISCUSSION

In OBE based on the POs and PSO defined, various courses are incorporated in the curriculum with fixed number of credits based on the number of teaching

hours. Normally one credit equals 12 to 15 teaching hours and for a 4-credit course there should be 4 to 6 CO developed. Engineering programs offered globally have 150 credits, AICTE in recent years has fixed 4-year undergraduate engineering program to 160 credits but some universities have extended it to 180 or even 200 credits. In view of AICTE approving the examination reforms policy, soon we may see its wide spread application and open book examination will be the norm in years to follow.

### Revised Blooms Taxonomy

In 1956, Benjamin Bloom and his team introduced the framework for categorizing educational goals. The Revised Bloom's Taxonomy, an updated version, surpasses the original model, addressing its shortcomings and aligning with contemporary educational practices. Illustrated in Figure 2, this revised taxonomy organizes cognitive skills into six levels, placing a significant emphasis on active learning and higher-order thinking. At the foundational "Remembering" level, learners are tasked with recalling or recognizing facts, information, or concepts, demonstrating the ability to retrieve knowledge and identify key elements. Progressing to the "Understanding" level, learners showcase comprehension and interpretation by explaining ideas, summarizing concepts, and making predictions. As learners ascend to the "Applying" level, they apply acquired knowledge and skills in new or unfamiliar situations, involving problem-solving and procedural implementation. The "Analyzing" level requires learners to break down complex information, identify patterns, and make connections, organizing and categorizing elements. At the "Evaluating" level, critical assessment and decision-making come into play as learners evaluate information, arguments, or hypotheses based on specific criteria. They assess, critique, justify, and prioritize various elements. Finally, at the pinnacle, the "Creating" level demands originality and creativity. Learners at this stage generate new ideas, design innovative solutions, invent novel approaches, and integrate knowledge and skills to produce unique outcomes.



REMEMBER	UNDERSTAND	APPLY	ANALYZE	EVALUATE	CREATE
This involves recalling information without necessarily understanding it.	Comprehending information by interpreting, summarizing, or explaining	Applying acquired knowledge in new situations or solving problems.	Breaking down information into parts and understanding relationships.	Making judgments based on criteria and evidence.	Synthesizing information to generate new ideas or products.
<b>Example Action Verbs:</b> List, Define, Recall, Identify, Memorize  <i>Example:</i> Recall the names of the capital cities in Europe.	<b>Example Action Verbs:</b> Explain, Summarize, Paraphrase, Describe, Interpret  <i>Example:</i> Summarize the main ideas of a historical speech.	<b>Example Action Verbs:</b> Apply, Solve, Use, Demonstrate, Illustrate  <i>Example:</i> Apply knowledge of grammar rules to edit a paragraph for clarity.	<b>Example Action Verbs:</b> Analyze, Compare, Contrast, Differentiate, Examine  <i>Example:</i> Analyze the motives of characters in a novel.	<b>Example Action Verbs:</b> Evaluate, Assess, Judge, Critique, Prioritize  <i>Example:</i> Evaluate the ethical implications of a decision in a case study.	<b>Example Action Verbs:</b> Evaluate, Assess, Judge, Critique, Prioritize  <i>Example:</i> Create a multimedia presentation to showcase the impact of climate change on ecosystems.

Figure 2. Blooms Taxonomy

The updated taxonomy equips educators with a versatile instrument for crafting instructional strategies, creating assessments, and cultivating higher-order thinking skills in students. Emphasizing action-oriented verbs linked to each level, it underscores the dynamic aspect of learning and the practical application of knowledge. Furthermore, the incorporation of the knowledge dimension acknowledges diverse types of knowledge essential for different cognitive processes. In essence, the revised Bloom's Taxonomy urges educators to involve students in purposeful and stimulating learning encounters, nurturing profound comprehension, critical reasoning, and inventive problem-solving capabilities.

**Develop Course Outcomes (CO)**

The general guidelines for writing course outcomes as follow.

- o Use Action Verbs: Use explicit and quantifiable action verbs, including analyze, evaluate, demonstrate, apply, create, and compare, while crafting Course Outcomes (COs) to accurately articulate anticipated student learning and accomplishments. You may emphasize these action verbs within your course outcomes, as illustrated in Table 1, or assign a numerical prefix starting from 1 to each CO for clarity.
- o Cover Different Cognitive Levels: Ensure COs span various cognitive levels, drawing from Bloom's

Taxonomy, to engage students in diverse thinking processes like remembering, understanding, applying, analyzing, evaluating, and creating.

- o Be Achievable: Craft COs that are realistic and attainable within the course's timeframe, considering the course level, student backgrounds, abilities, and available resources.
- o Be Measurable: Design COs that are observable and measurable, facilitating progress assessment through appropriate evaluations. Avoid the use of two action verbs, like "Differentiate and Analyze," and reframe as needed.
- o Count: Aim for a preferable range of 4-6 Course Outcomes for a 4-credit course.

Illustrating these principles, a case study explores a Computer Science&Engineering program, aligning COs with the Revised Bloom's Taxonomy. The outcomes, represented in Table 1 for the Machine Learning subject, exemplify how action verbs and corresponding RBT levels structure and assess cognitive complexity. Note that actual COs may vary based on specific course objectives. This approach not only enhances learning experiences but also aligns with the educational objectives of providing quality and inclusive education, as emphasized by SDG 4.

**Table 1. Examples of well-written course outcomes**

Upon completion of this course, students will be able to	
PCC-CS 604.1	Explain Machine Learning concepts.
PCC-CS 604.2	Analyze the Machine Learning model
PCC-CS 604.3	Design solution using Machine Learning techniques.
PCC-CS 604.4	Apply Machine Learning concepts and methods to find solution to real-world problems in domain of data mining, information retrieval, computer vision, linguistics and bioinformatics, etc.

**Mapping CO’s with PO’s and PSO’s**

Aligning course outcomes with program outcomes and program-specific outcomes is crucial to guarantee that students acquire the essential skills and knowledge for success in their chosen field. The alignment signifies that courses are meticulously designed to aid students in accomplishing the overarching goals of the program. This synchronization plays a pivotal role in ensuring that upon graduation, students possess the requisite skills and knowledge either to seamlessly enter the workforce or pursue further education. Program-specific outcomes are uniquely tailored to each program's focus. For instance, an engineering program might emphasize outcomes related to designing and constructing structures. When course outcomes align with these program-specific objectives, it signifies that the courses are effectively contributing to students attaining the program's core goals. This strategic alignment safeguards that students graduate with the necessary expertise to excel in their chosen field.

**Table 2. Sample CO-PO-PSO Mapping**

CO	PO1	PO2	PO3	PO4	PO5	PO6	PO7	PO8	PO9	PO10	PO11	PO12	PSO1	PSO2
PCC-CS 604.1	3	3	3	2	2	-	-	-	-	-	-	-	3	2
PCC-CS 604.2	3	3	2	3	3	-	-	-	-	-	-	-	3	2
PCC-CS 604.3	2	3	2	3	3	-	-	-	-	-	-	-	3	2
PCC-CS 604.4	2	3	3	3	2	2	-	-	-	1	-	-	3	3

Above Table 2. shows the correlation matrix of Course Outcomes with Programme Outcomes (CO-PO) for the courses PCC-CS604.1, PCC-CS604.2, PCC-CS601.3, and PCC-CS601.4 The correlation matrix shows the level of correlation between each course outcome (CO) and each program outcome (PO). A correlation of 1 indicates a strong correlation, a correlation of 2 indicates a medium correlation, and a correlation of 3 indicates a low correlation. With this mapping we can identify courses essential for students to learn the skills and knowledge that they need to be successful in their chosen field.

**Justification of Mapping of Course Outcomes with Program outcomes**

The basis behind aligning course outcomes with program outcomes and program-specific outcomes is to guarantee that students acquire the necessary skills and knowledge for success in their chosen field. This alignment allows us to discern how each course contributes to the overall learning objectives of the program. This strategic mapping ensures that students do not enroll in irrelevant courses and, instead, derive maximum value from their educational experience. Program-specific outcomes

are tailored to a specific program or field of study. For instance, a computer science program might include outcomes related to designing and developing software, utilizing computer science techniques to analyze and solve problems, and effectively communicating about computer science concepts. The accompanying image provides a sample illustration of the justification for aligning course outcomes with program outcomes (CO-PO).

**Table 3. Sample CO-PO Justification**

Course Code	Justification
PCC-CS604.1	An in-depth knowledge of mathematics and engineering is required to understand the basics of Machine Learning. (PO1). Only with the fundamentals learnt, problems in the field of Artificial Intelligence can be analyzed and find solutions through ML tools (PO2, PO3, PO4 & PO5).
PCC-CS604.2	A good mathematical and engineering fundamental is required to describe Machine Learning process (PO1) and hence formulate problems on Machine Learning (PO2). By describing ML processes, analyzing given data (PO3) and thereby develop a model (PO4) to find solutions using advanced tools (PO5), can be done.
PCC-CS604.3	A moderate Engineering and mathematical background are essential to assimilate various types of Python libraries (PO1). With the knowledge assimilated, problems related to given data and thereby designing solution, through ML algorithms can be done (PO2, PO3, PO4 & PO5).
PCC-CS604.4	A moderate mathematical and engineering fundamental is required to apply ML concepts (PO1) and hence formulate problems on given data (PO2& PO3). Apply data ML concepts and methods to find solution to real-world problems and communicate these solutions effective with ensure the responsible use of data to benefit society (PO4, PO5 & PO6)

Similarly, a well written proper justification is needed for CO-PSO mapping also.

**Decide CO Assessment Tools**

Two primary categories of assessment tools, namely

Direct and Indirect, are employed to gauge the achievement of course outcomes. Direct assessment tools, exemplified below, directly evaluate students' knowledge, understanding, and application of course content:

- o Exams and quizzes assess theoretical knowledge, understanding, and problem-solving abilities. Performance assessments, such as projects, presentations, simulations, or case studies, enable students to demonstrate skills in real-world contexts.
- o Practical assessments involve hands-on activities, laboratory experiments, or fieldwork to test the application of theoretical knowledge.
- o Observations include direct scrutiny of students' performance in class, discussions, or group activities to evaluate participation, engagement, and interpersonal skills.

In contrast, examples of Indirect Tools, which provide insights through external perspectives, are outlined below:

- o Surveys and questionnaires gather feedback from students, alumni, or employers regarding the perception of course outcome attainment and curriculum effectiveness.
- o Interviews and focus groups collect qualitative data from students, faculty, or stakeholders to gain insights into their experiences and suggestions related to course outcomes.
- o Self-assessment tools, like questionnaires or rubrics, enable students to reflect on their learning, skills, and progress.
- o Course evaluations involve standardized forms or online platforms to gather student feedback on various course aspects, including course outcome attainment.
- o Program-level assessments analyze student performance data, graduation rates, or institutional data to infer course outcome attainment at the program or institutional level.

To calculate Course Outcome (CO) attainment, the paper proposes a simple common assessment tool

outlined in Table 5, emphasizing the importance of aligning assessment tools with the nature of course outcomes and the desired level of evaluation. The proposed method assigns an 75% weightage to direct assessment, covering Continuous Internal Evaluation (CIE), Practicals/Tutorials, and University/Semester End Examinations, and a 25% weightage to indirect assessment, implemented through the Course Exit Survey. This comprehensive approach, incorporating both direct and indirect assessment tools, enhances the understanding of students' learning and course outcome attainment.

**Table 5. Basic Assessment Tools**

Direct (75 %)			Indirect (25 %)	
Tools	Assessment	Assessment Cycle	Tool	Assessment Cycle
CIE -I	Internal	One class test per semester	Course Exit Survey	One per semester
CIE- II	Internal	Second class tests per semester		
Practical's	Internal	Once in a Week		
University Exam	External	One per semester		

**Setting threshold and CO Target**

The course outcomes attainment performance framework encompasses threshold levels, attainment parameters, and target attainment, providing a methodical approach to assess student performance in alignment with a course's learning outcomes. Threshold levels set the minimum performance standards that students are expected to meet, serving as benchmarks for satisfactory understanding and competency. Determined based on factors like the institute's age, student quality, and academic offerings, these levels establish a baseline. Attainment parameters specify the desired percentage of students meeting or exceeding the threshold, offering a gauge of success in achieving learning outcomes. Target attainment signifies the specific performance goal set for students, guiding efforts to reach a desired level of achievement. This framework aids educators

in evaluating teaching methods, curriculum design, and assessments, fostering continuous improvement in course outcomes attainment. An example illustrating the establishment of thresholds and CO targets is provided below.

**Table 6. Basic Example for Setting Threshold & CO Target**

Attainment	Parameter
3.0	86-100% student score more than 40% marks (Direct + Indirect) for CO
2.0	71-85% student score more than 40% marks (Direct + Indirect) for CO
1.0	55-70% student score more than 40% marks (Direct + Indirect) for CO
Target Attainments	
2.0	71-85% student score more than 40% marks (Direct + Indirect) for CO.

The example provided in Table 6 establishes the threshold and CO target for course outcomes attainment. Threshold levels, denoted as 3.0, 2.0, and 1.0, delineate varying ranges of student performance, with higher levels indicating greater performance expectations. Attainment parameters, ranging from 86-100% for a threshold of 3.0, 71-85% for 2.0, and 55-70% for 1.0, specify the percentage of students expected to exceed the 40% threshold in assessments for each course outcome. The target attainment level is set at 2.0, aiming for 71-85% of students to surpass the 40% threshold. This targeted approach facilitates the assessment of course outcomes achievement, highlighting areas for improvement and continuous enhancement in teaching and assessment strategies to meet students' learning objectives.

**CO attainment Calculation**

The CO Assessment process involves several steps. Initially, course outcomes are evaluated through Continuous Internal Evaluation (CIE), University/Semester End Examination, Practicals/Tutorials, and Course Exit Survey to analyze the attainment levels of COs. Subsequently, student performance is calculated based on the achievement of a threshold value (above 40%) in both direct and indirect assessments for each

course outcome. The attainment of COs for individual courses is determined by averaging across all Direct Assessment Tools and Indirect Assessment Tools addressing individual COs.

The overall CO attainment is then calculated by taking 75% of the average direct attainment and 25% of the

average indirect attainment using below formula as shown in Figure 3.

CO Attainment=(Average of Direct Attainment addressing individual CO×0.75)+(Average of Indirect Attainment addressing individual CO×0.25)

CO	Attainment CIE-1	Attainment CIE-II	Attainment Practical	Attainment SUK	Final Direct Attainment (A)	80 % of Direct (A)	Indirect Attainment	20 % of Indirect (B)	Final A+B
CO1	3		3	3	3	2.4	3	0.6	3
CO2	3		3	3	3.0	2.4	3	0.6	3.0
CO3	2	3	3	3	2.8	2.2	3	0.6	2.8
CO4		2	3	3	2.7	2.2	3	0.6	2.8

Figure 3. CO attainment calculation

Finally, the calculation of Program Outcomes (POs) or Program Specific Outcomes (PSOs) through a course involves summing the product of overall CO attainment and CO-PO mapping, divided by the sum of the Maximum PO Mapping Factor. The calculation

methodology is exemplified in the Figure 4, with the highlighted last row indicating the contribution of the specific course to PO attainment

$\sum (\text{Overall CO attainment} \times \text{PO mapping factor}) / \sum (\text{Maximum PO Mapping Factor})$ .

PO		PO1	PO2	PO3	PO4	PO5	PO6	PO7	PO8	PO9	PO10	PO11	PO12	PSO1	PSO2
CO	Attainments														
CO1	3	3	3	3	2	2								3	2
CO2	3	3	3	2	3	3								3	2
CO3	2.8	1.9	2.8	1.9	2.8	2.8								2.8	1.9
CO4	2.8	1.9	2.8	2.8	2.8	1.9								2.8	2.8
Final PO Attainment		2.4	2.9	2.4	2.65	2.4	1.8				0.9			2.9	2.2

Figure 4. CO-PO-PSO attainment of the Course

Action plan for attained and unattained Course Outcomes

The evaluation of Course Outcomes (COs) through a methodical process, outlined in Figure 1, involves both Direct and Indirect Assessment tools. Post internal and external assessments, CO attainment is computed utilizing a predefined formula, with 75% weightage

assigned to Direct Assessment Tools and 25% to Indirect Assessment tools. The achieved CO levels are then assessed against the established threshold for each CO. If the attainment surpasses the threshold, adjustments may be made for subsequent years to sustain a rigorous standard, fostering ongoing improvement and motivating students to aim for elevated levels of accomplishment.

Table 7. Action Plan for Attained Course Outcomes

Course outcome	Target	Attainment	Gap	Attained	Action Plan for Next Academic Year (A.Y)
CO1	2	3	1+	YES	Will set new higher targets or attainment levels for next A. Y
CO2	2	2.2	0.2 +	YES	
CO3	2	2.5	0.5+	YES	
CO4	2	3	1+	YES	



However, in cases where the attainment falls below the established threshold, the course and module coordinators initiate essential measures to bridge the gap. This might include incorporating co-curricular activities, arranging supplementary classes or tutorials

for all students, hosting expert lectures, and delivering remedial classes tailored to the needs of students requiring additional support. These interventions are designed to enrich student learning and promote the achievement of Course Outcomes (COs).

**Table 8. Action Plan for Unattained Course Outcomes**

Course outcome	Target	Attainment	Gap	Attained	Action Plan for Next Academic Year (A.Y)
CO1	2	1	1-	NO	Conduct remedial classes.
CO2	2	1.5	0.5-	NO	Organize Extra classes or Tutorials.
CO3	2	0.8	1.2-	NO	Organize Expert Lectures.
CO4	2	1	1-	NO	Conduct Co-curricular activities

By following this assessment process and taking appropriate measures based on the outcomes, educational institutions can continuously monitor and improve the attainment of COs. This iterative approach ensures that students are equipped with the necessary knowledge and skills, and any shortcomings are addressed to enhance the overall quality of education provided.

**CONCLUSION**

The process of crafting and achieving Course Outcomes (COs) involves a systematic approach integrating Program Outcomes (POs), Program Specific Outcomes (PSOs), and Revised Bloom's Taxonomy (RBT) levels. Effective assessment tools, including exams, assignments, and projects, are pivotal in evaluating CO attainment. This paper introduces a performance framework encompassing threshold levels, attainment parameters, and target attainment, facilitating a structured evaluation of student performance, aligning with the pursuit of Sustainable Development Goal 4 (SDG 4) - Quality Education. Establishing threshold levels as benchmarks enables the identification of satisfactory comprehension and competence in course materials. The assessment process combines direct and indirect assessment tools, with an 80-20 weighted distribution, aiding institutions in gauging the achieved CO levels against set thresholds. This comparative analysis empowers educational entities to gauge attainment levels, enabling strategic interventions for addressing gaps. These interventions encompass diverse approaches like co-curricular activities, supplemental classes, and personalized support for students requiring additional assistance.

This iterative process not only facilitates continuous monitoring but also ensures the enhancement of CO attainment. By employing such an approach, institutions can consistently enhance and fine-tune educational practices, ensuring students acquire essential knowledge and skills while maintaining a challenging academic standard. Ultimately, this paper underscores the critical role of outcome-based education in advancing the quality of education within higher education institutions, directly contributing to the realization of SDG 4's vision of inclusive and equitable quality education for all.

**REFERENCES**

- Jandrić, Petar, Ana Fuentes Martinez, Charles Reitz, Liz Jackson, Dennis Grauslund, David Hayes, Happiness Onesmo Lukoko et al. "Teaching in the age of Covid-19—The new normal." *Postdigital Science and Education* 4, no. 3 (2022): 877-1015.
- Pereira, Diana, Irene Cadime, Gavin Brown, and Maria Assunção Flores. "How do undergraduates perceive the use of assessment? A study in higher education." *European Journal of Higher Education* 12, no. 1 (2022): 1-17.
- MacDonald, Laura, Evan Thomas, Amy Javernick-Will, Jesse Austin-Breneman, Iana Aranda, Carlo Salvinelli, Rita Klees et al. "Aligning learning objectives and approaches in global engineering graduate programs: Review and recommendations by an interdisciplinary working group." *Development Engineering* 7 (2022): 100095.

4. Sugarman, Stephen D. "The Failed Quest for Equal Educational Opportunity: Regulating Education the Way We Regulate Business." *JL & Educ.* 50 (2021).
5. Misbah, Zainun, Judith Gulikers, Wahyu Widhiarso, and Martin Mulder. "Exploring connections between teacher interpersonal behaviour, student motivation and competency level in competence-based learning environments." *Learning Environments Research* (2022): 1-21.
6. Kushari, Berlian, and Lukman Septiadi. "A learning outcome assessment information system to facilitate Outcome-Based Education (OBE) implementation." *Jurnal Pendidikan Teknologi dan Kejuruan* 28, no. 2 (2022).
7. Mukesh, S. "Outcome-based learning: an overview." In *Proceedings of the International Conference on Best Innovative Teaching Strategies (ICON-BITS 2021)*. 2022.
8. Amirtharaj, S., G. Chandrasekaran, K. Thirumorthy, and K. Muneeswaran. "A systematic approach for assessment of attainment in outcome-based education." *Higher Education for the Future* 9, (2022): 8-29.
9. Harden, Ronald M. "AMEE Guide No. 21: Curriculum mapping: a tool for transparent and authentic teaching and learning." *Medical teacher* 23, no. 2 (2001): 123-137.
10. Joyner, Helen S. "Curriculum mapping: A method to assess and refine undergraduate degree programs." *Journal of Food Science Education* 15, no. 3 (2016): 83-100.
11. Suresh. D. Mane S.P. Dodamani. "Measures for Improving Undergraduate Engineering Education: An Emperical Study in the state of Karnataka". *The International Journal Of Engineering And Science (IJES)*, Volume 4, Issue 4, PP 40-46 (2015). ISSN (e): 2319 – 1813 ISSN (p): 2319 – 1805.
12. Erlinger, Allison. "Outcomes assessment in undergraduate information literacy instruction: a systematic review." *College & Research Libraries* 79, no. 4 (2018): 442.
13. Farmer, Elizabeth A. "Faculty development for problem-based learning." *European Journal of Dental Education* 8, no. 2 (2004): 59-66.
14. Sun, Poi Hun, and Sek Yan Lee. "The importance and challenges of outcome-based education-a case study in a private higher education institution." *Malaysian Journal of Learning and Instruction* 17, no. 2 (2020): 253-278.
15. Syeed, MM Mahbulul, A. S. M. Shihavuddin, Mohammad Faisal Uddin, Mahady Hasan, and Razib Hayat Khan. "Outcome based education (OBE): Defining the process and practice for engineering education." *IEEE Access* 10 (2022): 119170-119192.
16. Suresh. D. Mane, "Accreditation of UG Engineering Programmes in India: Enhanced Role of Teaching Fraternity." *International Journal of Scientific Engineering and Applied Science (IJSEAS)* - Volume-1, Issue-6, September 2015, ISSN: 2395-3470.
17. Suresh. D. Mane, "NBA and NAAC Accreditation of UG Engineering Programmes/Colleges in India: A Review". *International Journal of Scientific Engineering and Applied Science (IJSEAS)* - Volume-1, Issue-6, September 2015, ISSN: 2395-3470.

# Best Practices for Educational Sustainable Development

**Sanjana Sanjay Bhalkar**

Ph.D Researcher

Shivaji University

Kolhapur ,Maharashtra

✉ sanjanabhalkar12@gmail.com

**Pratibha Sadashiv Desai**

Principal

Aacharya Javadekar College of Education, Gargoti

Affiliated to Shivaji University

Kolhapur ,Maharashtra

✉ drpratibhadesai@gmail.com

## ABSTRACT

In lecture method students often get destructed to due lack of connection between what teacher is teaching and what student is interested to learn ?what they already knows and what doesn't know at all? And what stimulates his mind to probe further ?By using alternative methods ,internal quality assurance cell can set up an environment, for students to develop new connections ,with a world around him , in a receptive but relaxed state of mind.

Regardless of the complexity of your best practices ,the aim is to make whatever you are doing work out better, faster and more efficiently with fewer problems and mistakes. That is why it is always a good idea to be aware of what the best practices are for what you are trying to achieve. It is a framework for success and minimization of failure.

**KEYWORDS** : *Best practices, Educational sustainable development.*

## INTRODUCTION

**B**est educational practices as the wide range of individual activities ,policies and programmatic approaches to change students attitude or academic behaviours positively.

Current academic standards demand that educators emphasize depth of knowledge by encouraging students to understand a variety of challenging tasks .As they consider problems and create solutions ,students stimulate real world applications .The partnership for 21st century learning has outlined the knowledge ,they have identified the 'Four Cs '(Think critically ,communicate ,create and innovate and collaboration )as fundamental competencies that students must develop critical thinking ,problem solving ,activities ,communication ,collaboration and creativity and innovation.

### Objectives of the study

1. To study the concept of best practices .
2. To study the best practices in foreign countries.

3. To study the India's progress across sustainable development goals.
4. To study the best practices for educational sustainable development.

### Importance of the Study

Present study important for Teacher ,students ,educators ,Researchers for clear the concept of best practices and Educational sustainable development.

### Delimitations of the study

Present study delimited only best practices and educational sustainable development.

And Present study delimited for Teacher, students centred practices only.

### Research Methodology

For the present study, researcher used survey method for appropriate to achieve the objectives of the study.

### Analytical interpretation

Teachers ,Educators and Students are powerful change agents who can deliver the educational response

needed to achieve the Sustainable development goals. Their knowledge and competencies are essential for restructuring educational processes and educational institutions towards sustainability. Teachers must meet this challenges by reorienting itself towards Educational Sustainable Development. The monitoring and evaluation of the educational sustainable development has identified many good things and shown that the support of teachers has been a key condition to the successful adoption and implementing of Educational Sustainable Development.

However, efforts to prepare teachers to implement Educational Sustainable Development have not advanced sufficiently. More work still needs to be done to reorient teacher education to approach Educational Sustainable Development in its content and its teaching and learning methods. That is why is the Grand Academic Portal(GAP)'s priority Action 3 focuses on building capacities of educators. One of the Proposed actions in this area is integrate Educational Sustainable Development into Pre – service and in –service teacher education programmes.(UNESCO, 2014)

In order for teachers to be prepared to facilitate Educational Sustainable Development, they must develop Sustainability Competencies (including knowledge, skills, attitudes, values, motivation and commitment.) But in addition to general sustainability competencies, they also need Educational Sustainable Development competencies, which can be described as a teacher's capacity to help people develop sustainability competencies through a range of innovative teaching and learning practices.

Country examples of good Practices of teacher education programmes integrating Educational Sustainable Development

Jamaica – Pre –service teachers learning through Educational Sustainable Development community action projects

“literature and education for sustainable development is a core course for students pursuing the graduate programme in language education, and an elective for students in the graduate programme for teacher education at the university of the West Indies, Mona,

Jamaica. The course work to introduce students to the concept and principles of sustainable development and to provide them with opportunities to explore the role of Educational Sustainable Development in creating a sustainable world.

There are three components to the course :

1. A global framework in which students examine local and global sustainability challenges.
2. The study of literature as a means to develop empathy, give students a sense of community, clarify values, understand sustainability from multiple perspectives and motivate them to act.
3. Engagement of community action projects. As a major assignments, students are required to address sustainability challenges in their community. students have chosen to address issues of violence, poverty and environmental degradation through peace projects, working with the homeless, school gardening and bee keeping, to name a few. students have found the course most useful as they attend to real world problems and work closely with their communities. They come to understand that they can learn from, as well as help improve the quality of life in their community.

#### **Greece-In –service teacher training**

“The Ministry of Education established 46 centres for environmental education and sustainability under the regional directorates of education all over the country. The projects these centres at running aim at training teachers in order to implement projects related to Educational Sustainable Development in their schools. During the 2011 school year, 184 seminars for 8,745 teachers of primary and secondary education took place. (UNESCO,2014)

These elements of Educational Sustainable Development competencies are described in much more details in a number of different conceptual frameworks of teacher competencies in the field of.

Country examples of good practice of integrating Educational Sustainable Development in policies

Costa Rica-Profile of success in embedding Educational Sustainable Development into sustainable development policies

“in 2006 ,Costa Rica approved the National Commitment on the Decade of education for Sustainable Development ,agreeing to consider education as an indispensable aspect for generating cultural change towards sustainable development, and to promote the incorporation of environmental education into trans-disciplinary subjects. The most recent comprehensive national policy instrument on climate change, the national strategy on climate change ,include capacity – building and public awareness ,education and cultural change ,with the aim of increasing environmental literacy. The example of Costa-Rica shows how sustainable development policies that include Educational Sustainable Development can help to reinforcement and drive changes in education systems.

Kenya- Kenya’s Educational Sustainable Development implementation strategy ,adopted in 2008 ,acknowledges that in order to have ‘quality education and training for development ,’ education should promote the development of productive and socially responsible individuals .This Educational Sustainable Development strategy at promoting teaching and learning that inculcates appropriate values, behaviour and lifestyle for good governance and sustainability among other focuses. In vision 2030 ,Kenya’s roadmap to the realization of sustainable development ,showing the importance of alignment with national sustainable development objectives.

#### Action Projects for Sustainable development in India

The following narrative further encapsulates India’s progress across the Sustainable Development Goals.

Sashakt Bharat - Sabal Bharat (Empowered and Resilient India); Swachh Bharat - Swasth Bharat (Clean and Healthy India);. Samagra Bharat - Saksham Bharat (Inclusive and Entrepreneurial India): India has successfully lifted more than 271 million people out of multidimensional poverty through economic growth and empowerment. Enhanced access to nutrition, child health, education, sanitation, drinking water, electricity and housing, has led to reduced inequalities especially among people in vulnerable situations.

Best practices for Educational Sustainable Development :-

Collaborative real world projects ,such as service

learning projects and campaign for different sustainable development.

Vision building exercise such as future workshops, story telling, science fiction thinking.

Debate issues of environment, sustainable development ,using water, fresh air, etc...

Celebrate the National/International environment day.

Develop an enquiry based project for sustainable development.

Critical and reflective thinking through discussion ,reflective journals etc...

Action based learning ,learners engage in action and reflect on their experiences in terms of intended learning process and personal development .have them help you plant flowers ,trees ,fruits or vegetables in your garden or in planters .Teach them about how plants grow and taking care of nature and waste for best concept.

Teach them about actions they can take to help the environment. Set a good examples by showing them eco- friendly actions such as using reusable water and grocery bags or walking ,using cycle or taking public transportation instead of driving whenever possible.

Read books and watch them videos about the sustainable development.

Classroom best practices are devised through regular training ,brainstorming sessions ,activities, project based learning and group discussion the same are dynamic and revised and revised periodically

#### Conclusion according to objectives

1. To study the concept of best practices .
2. To study the best practices in foreign countries.
3. To study the India’s progress across sustainable development goals.
4. To study the best practices for educational sustainable development.

#### CONCLUSION

Most countries today, including India, find it difficult to balance economic growth and environmental protection. This allows countries to experience economic growth



at the cost of severe environmental degradation and social and economic inequalities. Good practices for Educational Sustainable Development, quality education with effective education policies, is the key to finding a balance between economic growth and environmental protection. In India, the National Education Policy was first drafted in his 1986 and subsequently changed in 1992. Since then, many changes in education policy have been made from time to time in response to the needs and changing nature of the world. It is clear that an effective education policy will always result in quality education in the country. A welcome and exciting reform of the Indian education system towards a modern, progressive and egalitarian system is a national education policy based on the principles of access, equity, quality, affordability and accountability in education. 2020 (NEP 2020). NEP 2020 links India with the 2030 Agenda for Sustainable Development (SD) by making schooling and higher education more inclusive, flexible and adaptable to the needs of the 21st century, making India a dynamic knowledge society and a global knowledge powerhouse.

#### Recommendations of the study:-

1. For Educational Sustainable Development in various subject we have to use best practices along with traditional teaching method.
2. In primary ,higher primary, secondary, higher secondary level best practices teacher must be used for sustainable development of education.

#### REFERENCES:-

1. Best J. W., Khan J., Jha A.R.(2017);Research in Education;pearson in South Asia.
2. Patil.A (2022):National Educational Policy2020-Heart of sustainable development goals 2030,international journal for multidisciplinary research,volume4,issue 5.sep- oct20222 1.8

#### Websites-

3. <https://in one .un /page/sustainable-development goals /quality education in india –sdg-4/> Retrieved on 14 Jan 2024
4. <https://www.unesco.org/en/education/sustainable-development> Retrieved on 14 Jan 2024
5. <https://allforyou.in> 10 jan 2023,Retrieved on 23 Dec2023
6. <https://mpscplanner.com>.25july2021,Retrieved on 20 Dec2023
7. <https://classful.com/best -practices-in education/> Retrieved on 13 Jan 2024
8. [www.researchgate.net](http://www.researchgate.net) Retrieved on 13 Jan 2024

# Educational Leadership in 5 IR : Nurturing Sustainable Innovators

**Shivaji Govind Sawant**

Ph.D. Student  
Interdisciplinary Studies (Education)  
Shivaji University  
Kolhapur ,Maharashtra  
✉ shivajisawant141@gmail.com

**R. K. Shelake**

Associate Professor  
Acharya Jawadekar College of Education, Gargoti  
Shivaji University  
Kolhapur ,Maharashtra  
✉ drrkshelake@gmail.com

## ABSTRACT

The profession of educational leadership has improved significantly. Educators have better understanding on how and what ways, educational leadership has contributed to the student achievement. An increasing base of knowledge from research and practice has depicted that the primary job of the educational leaders is to put emphasis upon student achievement by formulation of challenging, caring and supporting environmental conditions that are conducive to student learning. They develop and support teachers create constructive working conditions.

**KEYWORDS** : *Educational leadership, Education leaders, Students, Emphasis.*

## INTRODUCTION

**E**ducational Leadership : It is a process of enlisting and guiding talents and energies of teachers, students and parents towards achieving common educational aims.

Certain obstacles of educational leadership can be overcome - self assessment technique can help examine equity and justice that affect students diversity, especially with selection of candidates.

During the pandemic, effective leadership was required to address a challenge brought on by a public health crisis.

Educational leadership has often focused on addressing the needs of specific student populations or on making education more accessible to students with learning disabilities or other challenges.

## 5 IR IN EDUCATION

In education industry 5.0 refers to the co-operation between these technologies and educators and students to enhance the efficiency and effectiveness of teaching and learning. Industry 5.0 technologies have the potential to revolutionize the way students learn and teachers teach.

The significant 5 R's are :- Read, Review, Recycle, Reflect and Research.

### Reading

Reading habits are directly proportional to vocabulary growth. Reading is mainly categorized into two types : Extensive and intensive. Both of these types are helpful in developing and strengthening vocabulary skills.

The another way of effective reading is reading by applying word-forms. In this reading and exploring the word's origin, as it becomes easy for learners to learn by understanding the vocabulary base-forms.

### Review

Using themes is one efficient method to level-up and retain vocabulary from varied fields. In this method, learners can use themes such as :- colors, cooking, pets, maths, science, technology etc.

Organising reading and work-making competitions are the smartest ways to review and engross the vocabulary learnt in a term.

### Recycle-

Learners can create boards on web-applications and save the varied vocabulary. Another simple method to

recycle vocabulary is by selecting and saving a list of words that the learner's struggle work.

### Reflecting

Estimated lexical range is collected from the standardized tests, and the scores can be used to reflect on reading habits and to analyse the activities that have been powerful over the previous term.

Reading and learning materials should always be open to all learners as a classroom resource, explanations or learning activities can vary as per their academic levels.

## RESEARCH

Languages are even evolving, and the vocabulary is the main ingredient in this process. To meet the growing demands, learners need to read the latest global news and hot topics in hand. We can guide learners to create their own learning resources based on their needs.

### Principles of Educational Leadership

A teacher is a leader truly, a teacher is many things.

Defining leadership, though is not hard. A leader brings a group from one place to another in a co-ordinated way. We can define leadership as 'leading is primarily about guiding the group that does not work.'

#### Principles-

Clear, simple communication :-

The first principle in educational leadership is effective communication. There are so many ways in which we miscommunicate largely because we know that what we mean and we assume everyone else knows what we mean.

#### Co-ordinate your team-

Keeping your team of students together and pulling in the same direction is at the heart of leadership.

### Long - range Objectives

Lesson - planning is all about connecting the day's lesson to objectives. The teacher as a leader must consider a number of objectives on the horizon and lead the group toward those goals every day, each lesson.

### Prioritization

Hand in hand with long-range objectives is prioritization. The day-to-day life of classroom can be chaotic. As much as we plan. We can get through off that plan quite easily.

### Empower your people-

This is a principle of leadership that operates all levels of school. The teacher much take initiative to achieve the goal of the school. The teacher should empower the students to take the hold of the tools that can enable them to achieve objectives.

### Cultivate Humility

A teacher can be a level five leader. You would see in this kind of person a mix of ambition and quite reserve. The level five leader is driven by the cause.

The teacher must take up all these principles collectively and act efficiently.

### Results for Educational Leadership

By educational leadership, we mean social relationship or interactions tied to the core work of schooling- teaching - that are intended or understood to the influence of the motivation, knowledge and affect educational teachers, students, parents, school and system staff.

## CONCLUSION FOR EDUCATIONAL LEADERSHIP INCLUDING 5 IR

Teacher leadership in schools have become more appearant, there has been a more towards teacher leadership characterized by a form of collective

leadership in which teachers develop expertise by working collaborately. For this purpose teachers use 5 Rs.

### **Read, Review, Recycle, Reflect and Research**

It is concluded that teacher leadership could have been beneficial effects on school improvement, school and teacher effectiveness and teacher motivation and retention, but that the right conditions need to be in place in order for teacher leadership to flourish.

### **REFERENCES :-**

1. [www.researchgate.net](http://www.researchgate.net)
2. Wikipedia - <https://en.m.wikipedia.org>
3. <https://soeonline.american.edu>
4. <https://www.researchgate.net>
5. <https://educationalrenaissance.com>
6. <https://www.sciencedirect.com>

# Tech-Driven Education: Understanding the Impact of 4IR and the Prospects for 5IR Integration with a focus on SDGs

Mercy Fernandez

Pratibha Patankar

Department of Education  
Shivaji University  
Kolhapur, Maharashtra

## ABSTRACT

The current study focused on the impact of 4IR and its effect on the education system and what are the goals of 5IR which can be incorporated into the education system. The Goals of 4IR were cyber-physical systems, Artificial intelligence, Machine learning, Big Data, Internet of Things, which will help increase productivity. The question arises that are this 4IR technology really useful in education or just hype? The 5 Industrial Revolution (IR) saw advancements in activities from the previous 4IR which includes advancement in digital technologies like AI, robots, IoT, cloud computing, big data, and 3D printing, among others highlighting the significance of modern technologies in answering new and urgent requirements in the industrial, social, and environmental setting. The COVID-19 pandemic has affected the way the education system works. Sustainable development is the key concept in Industrial Revolution 5.0. This paper talks about 5IR and how it can be related to sustainable development Goals such as quality education how there is a shift from 4IR to 5IR and why it was necessary. There has been a significant movement in how the education system functioned before and after the pandemic, as there is a need to incorporate new technology in education since the transition in education has just recently changed to online mode, but the way teaching is done remains conventional. NEP 2020 has focused on education, which includes digital education as well, employing different AI, VR, and AR technologies, which are the goals to be achieved by 5IR keeping in mind the ethics related to it.

**KEYWORDS** : 4IR, 5IR, Impact, Education, (SDGs) Sustainable goals, Human-machine collaboration.

## INTRODUCTION

The 4IR and 5IR represent distinct stages in the industrial evolution. The 4th IR focused on the integration of digital technologies such as artificial intelligence, the Internet of Things, robotics, and advanced data analytics, whereas the 5th IR focused on describing the next phase of technological advancement, which included a variety of areas, one of which is sustainable development. The 5IR was built on the foundation of 4IR, having an emphasis on developing improved and sustainable technologies. Datafication of virtually everything created ultimate information in 4IR where the focus shifted towards machines and AIs and here the question also arises whether the jobs of humans would be taken away by machines. The 5IR in which the central point is a collaboration between humans

and technology not only focuses on technological advancement but also addresses environmental and societal issues and concentrates on multiple stakeholders (Society, Company, employee, customers, education etc.). In contrast, the 4IR can be summarised as a competitive one where machine v/s human was the highlight. The most recent impact we can understand is from the covid 19 pandemic. We had technologies that were developed in 4IR but the education system did not keep up with improvements which were in the Fourth Industrial Revolution. While society has progressed from the First Industrial Revolution (1IR) to the present Fourth Industrial Revolution (4IR), most education systems remain in the Education 2.0 period rather than Education 4.0. During the pandemic, we have shifted toward online learning and the use of technology to connect with the world but is it, really up to the date



of 4IR? Certainly not, as the shift was towards the use of online platforms but the teaching and learning mode was still traditional one. Skill gaps among educators can be noticed as the rapid integration of technology has shifted the mode of teaching but the lack of skills of educators to develop and use new tools has been a concern till now. The rise in technology leads to resource depletion and the production of electronic waste which have contributed to pollution and have raised the environmental concern. The automation of certain jobs has led to concerns about unemployment for some time. The advancement in technology such as AI has raised ethical dilemmas, we can think of the example of the Trolley problem (Thomson,1984) which was a thought experiment on ethics and moral philosophy. That explores the ethical dilemma of sacrificing one individual to save many others. This can be understood with an example of automated cars which were the product of 4IR so further advancement in the technology which has solutions to solve the ethical dilemma was necessary this can be done by teaching future engineers and consumers how to train an AI to take the right decision which results in maximum safety of individuals for this the citizens should be informed and this can be done by means of education. Sustainable development means development that meets the demands of the present without compromising the ability of future generations to meet their own needs.<sup>17</sup> sustainable development goals (Gupta,2016) are proposed. The 4th goal of sustainable development is quality education. This goal is the effort to achieve essential improvement to increase the transformative learning need for realising a sustainable future for all. As the 5IR navigates toward the future it is important to impart skills that empower children to be equipped with technology. The following are the skills which should be inculcated in the students for example Creativity, Critical thinking, Adaptability, Communication and collaboration. The 5IR is a shift from a competitive to a cooperative approach where automation and AI will transform the way we live and work. The foremost important thing is that our children must be equipped with skills and the teaching methods should be student-centric for example the activity-based approach, Constructivist approach, Flipped classroom approach, Gamification in education, etc. SDG's 4th goal of Quality education ensures inclusive

and equitable quality education to promote lifelong learning opportunities for all and 5IR along with SDGs will open the door for access and quality in education.

## STATEMENT OF PROBLEM

Tech-Driven Education: Understanding the Impact of 4IR and the Prospects for 5IR Integration with a focus on SDGs.

## METHODOLOGY

The primary approach of this study includes qualitative research, literature analysis using Google, and interpretation based on relevant reviews. This review assisted the researcher in understanding the 4IR and 5IR, which strive to achieve sustainable development, as well as their influence on the education system and the necessary reforms. This study chooses Google as the primary database to collect related information for analysis, so that this study can investigate what is the current state of education in 4IR and what changes are required with the arrival of the 5IR, keeping in mind the SDGs goals, particularly Goal 4 of SDG, which is Quality Education, and how we can incorporate technology.

## LITERATURE REVIEW

The advancement of the Fourth Industrial Revolution (robotics, artificial intelligence, augmented reality, virtual reality, and so on) has resulted in an emerging scenario in which the service of mankind is too frequently overshadowed by the impetus of technology and business. This difficulty has lately been emphasized, as some of the main creators of the Fourth Industrial Revolution have begun to abandon their intellectual property due to the dangers that they face as its owners. These Fourth Revolution captains believe that emerging technologies have the potential to be an "enemy of the people". Meanwhile, our economic engines continue to scream and emit figurative smoke into the atmosphere, while the world's population expands and the aspirations of human flourishing fall short (What the Fifth Industrial Revolution Is and Why It Matters, 2019). AVs are self-driving, crewless vehicles that communicate with other road users using sensors, cameras, light detection, range systems, and artificial intelligence. They can achieve five automation levels,

with the third level achieved in 2020. Advances in computer vision and motion sensor technologies have led to collaborative robots, or cobots, that assist humans in dangerous jobs, predict future movements, and make flexible decisions in manufacturing. Automated Guided Vehicles are examples of such cobots. (Fanoro et al., 2021). The COVID-19 pandemic has hastened the adoption of Fourth Industrial Revolution technology. These technologies assist in limiting the pandemic, protect and supply key services to billions of people, enable remote learning and employment, and restore economic resilience. SDG4 aims to ensure inclusive and equitable quality education and encourage lifelong learning opportunities for everyone. COVID-19 has expedited the digitization of education across all levels. In the future, blended learning, which includes both online and in-person learning, will become the norm. Reskilling and getting updated information are crucial in today's rapidly changing work market and culture of lifelong learning.

4IR innovations can enhance interactions between lecturers and students, including capstone projects with students from different time zones and industry partners, assessment tools, and laboratory-based subjects. Furthermore, sustainability should be included in the education of children, adults, corporate leaders, and policymakers (Ramakrishna).

4IR represents technological advancement that has rapidly changed industries, economies, and social realities with the introduction of smart automation, machine-to-machine communication, and the Internet of Things. With the further expansion of artificial intelligence (AI) and chatbots like ChatGPT, digital technology has unmistakably made itself indispensable to mankind at all levels. While some parts of the world are still mesmerized by IR4.0, others are now moving towards IR5.0 – centring on humans working alongside smart machines. According to the European Commission, IR5.0 adopts a human-centric approach that is complemented by IR4.0 (European Commission) (Abu Kassim, 2023). Augmented Reality (AR) and Virtual Reality (VR) technologies have revolutionized learning approaches through immersive digital experiences, interactive environments, simulation and engagement. Yet, these technologies are in the

developing stage and require massive investment and mass customization to meet the high demand in education (Al-Ansi, 2023). The education industry is changing day by day and accepting new ways to cope with the change occurring in all aspects of life due to the Fourth Industrial Revolution. Professional teachers can help transform school environments to become hybrid learning communities. Organizations need to have a successful strategy and adopt new products of IR 4.0 such as big data, blockchain technology, and artificial intelligence in education instead of traditional procedures. (Joshi, 2022).

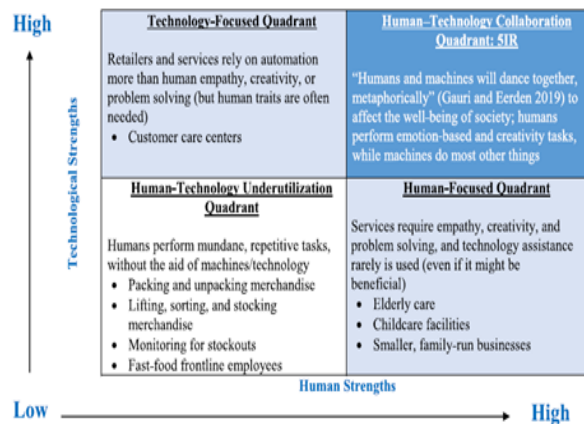

Fig- Maximizing human and technological strengths in the 5IR (Noble, 2022)

Create an enabling environment for learners, academics and practitioners to break barriers, imagine, innovate, create, and collaborate; develop a 4.0-ready ecosystem fitting to institutional contexts; stimulate greater human connectivity through the exchange of students and staff, which is enabled through global and regional networks, and consortium of higher education institutions; incorporate spiritual values, ethics and morality, national identity and a sense of connection to the community, through curriculum delivery and technology transfer; and be mindful of the benefits and risks brought about by the 4th Industrial Revolution. In the future, there will be a lot of changes in ways of teaching and learning. The content of the teaching, roles of lecturers and students. The logic of education systems should be reversed so that it is the system that conforms to the learner rather than the learner to the system. This is the essence of personalisation (Shahroom & Hussin, 2018).

Differences between the 4IR and 5IR.

		4IR	5IR
Human-technology focus	Maximization strategy	<ul style="list-style-type: none"> <li>■ Maximizing the number and scope of technologies and their interconnectedness</li> </ul>	<ul style="list-style-type: none"> <li>■ Maximizing the strengths of <i>both</i> technology and humans by understanding where each excels</li> </ul>
	Competition vs. collaboration	<ul style="list-style-type: none"> <li>■ Humans compete with machines for jobs</li> </ul>	<ul style="list-style-type: none"> <li>■ Humans and machines dance together, metaphorically</li> <li>■ Humans harmoniously collaborate with machines</li> </ul>
Well-being focus	Environmental emphasis	<ul style="list-style-type: none"> <li>■ No environmental emphasis</li> <li>■ Prioritization of technological progress (e.g., smart factories)</li> <li>■ Pursuit of profits</li> </ul>	<ul style="list-style-type: none"> <li>■ Well-being of all of humanity and the planet</li> <li>■ Focus on sustainable and renewable resources</li> <li>■ Pursuit of profits with a purpose</li> </ul>
	Pushing the boundaries of technology	<ul style="list-style-type: none"> <li>■ Need to trust technology</li> </ul>	<ul style="list-style-type: none"> <li>■ Humane uses of technology</li> </ul>

A lot of jobs will disappear, but there will be a lot of new job requirements. It is expected that more than 65% of children entering primary school today will end up working in completely new jobs that currently do not exist when they enter the workplace 15 years from now. (Sun, 2018). Even if there are disadvantages (or negative sides) of IR 4.0, it is important to apply its technologies and products in education to qualify students who have the competencies and skills to understand future challenges and try to solve them (Elayyan,2021). Changes could affect the quality of the graduates if students are not well prepared and there is insufficient investment in resources (Kayembe,2019). Harmonious collaboration in the form of harmony is added as a top layer in the Collaboration pillar. Together with harmony between humans and machines are considerations of ethics, trust, and risk (Van der Poll,2022).

### CONCLUSION

From the reviews of the related literature, the fundamental difference between 4IR and 5IR is clear, 5IR is the advancement in the 4IR goals along with sustainable development as one of the important goals of 5IR. Sustainable development has 17 Goals in which the 4th goal of sustainable development is quality education. This goal is the effort to achieve essential improvement to increase the transformative learning need for realising a sustainable future for all. As the 5IR navigates toward the future it is important to impart skills that empower children to be equipped with technology. The current education system needs to keep up with the new technology and new teaching pedagogy for effective implementation of the new blooming technology in 5IR. Augmented Reality (AR) and Virtual Reality (VR) technologies have the potential to revolutionize the world of education and create a more immersive and engaging learning experience for students. Education can play a key role in training the engineer and students to develop AI with the knowledge about the ethics and dilemma that can be tackled which was one of the limitations for 4IR and understanding the impact of 4IR and the prospects for 5IR Integration for sustainable future.

### REFERENCES

1. Al-Ansi, A. M., Jaboob, M., Garad, A., & Al-Ansi, A. (2023). Analyzing augmented reality (AR) and virtual reality (VR) recent development in education. *Social Sciences & Humanities Open*, 8(1), 100532.
2. Elayyan, S. (2021). The future of education according to the fourth industrial revolution. *Journal of Educational Technology and Online Learning*, 4(1), 23-30.



Fig-5IR Enhancement of Collaboration in Quality 4.0 (Van der Poll,2022)

3. Fanoro, M., Božanić, M., & Sinha, S. (2021, October 21). A Review of 4IR/5IR Enabling Technologies and Their Linkage to Manufacturing Supply Chain. *Technologies* (Basel). <https://doi.org/10.3390/technologies9040077>
4. Gupta, J., & Vegelin, C. (2016). Sustainable development goals and inclusive development. *International environmental agreements: Politics, law and economics*, 16, 433-448.
5. Joshi, Geetanjali, and Pratibha Patankar. "Fourth Industrial Revolution and Education: A Study." *IOSR Journal of Humanities and Social Science (IOSR-JHSS)*, Vol. 27, no. 7, 2022, pp. 20-25, [www.iosrjournals.org/iosr-jhss/papers/Vol.27-issue7/Ser-4/D2707042025.pdf](http://www.iosrjournals.org/iosr-jhss/papers/Vol.27-issue7/Ser-4/D2707042025.pdf), <https://doi.org/10.9790/0837-2707042025>.
6. Kayembe, C., & Nel, D. (2019). Challenges and opportunities for education in the Fourth Industrial Revolution. *African Journal of Public Affairs*, 11(3), 79-94.
7. Noble, S. M., Mende, M., Grewal, D., & Parasuraman, A. (2022). The Fifth Industrial Revolution: How harmonious human-machine collaboration is triggering a retail and service [r] evolution. *Journal of Retailing*, 98(2), 199-208.
8. Ramakrishna, S. Fourth industrial revolution technology for development of SDGs in UN
9. Shahroom, A. A., & Hussin, N. (2018). Industrial Revolution 4.0 and Education. *International Journal of Academic Research in Business and Social Sciences*, 8(9), 314-319
10. Sun, M. (2018). The Impacts of the Fourth Industrial Revolution on Jobs and the Future of the Third Sector. *NICVA*.
11. The Fifth Industrial Revolution (5IR) and how it will change the business landscape - RegInsights. (2022, January 3). RegInsights. <https://www.regenesys.net/reginsights/the-fifth-industrial-revolution-5ir>
12. Thomson, J. J. (1984). The trolley problem. *Yale LJ*, 94, 1395.
13. Van der Poll, J. A. (2022). Problematizing the Adoption of Formal Methods in the 4IR-5IR Transition. *Applied System Innovation*, 5(6), 127.
14. What the Fifth Industrial Revolution is and why it matters. (2019, May 16). The European Sting - Critical News & Insights on European Politics, Economy, Foreign Affairs, Business & Technology - [europeansting.com](http://europeansting.com). <https://europeansting.com/2019/05/16/what-the-fifth-industrial-revolution-is-and-why-it-matters/>

# Exploring the Collaborative Dynamics between Humans and Technology in the 5IR

**Vidya N. A.**

Asst. Professor  
Dr. D. Y. Patil Pratishthan's College of Engg.  
Kolhapur, Maharashtra

**Shivani Kale**

Associate Professor, CSE Dept,  
Dr. D. Y. Patil Pratishthan's College of Engg.  
Kolhapur, Maharashtra  
✉ dr.shivaanikalle@gmail.com

## ABSTRACT

The biggest challenge is at present and future is ability to see what happening in world things can different and much better than past tense and whether we like it or not, we are the one who must navigate it. We need to cover infinite possibilities. Take ownership of the revolution and involved towards the growth of the technology. Here I am contributing through some of literature review paper what industry facing and dynamic changes and challenges.

As technology growing advantages and Disadvantages will be there. At present Computer communication network playing vital role in our day today activities like online banking, marketing, and on line education e.t.c similarly handling big data analysis and cloud computing e.t.c To make network more efficient and secured we are using SDN.SDN has small history before SDN we had Traditional networking method like switching and routing system but as network congestion and increases the traffic it is difficult to handle in traditional method. By using Software define networking (SDN) it is possible to handle network traffic and security. In SDN Data plane and control plane are separated and control plane is powerful plane which carries the signal responsibilities and head to monitor the network with all securities, but we cannot provided complete security system to control plane. As we are concentrating how to protect control plain from smart threats in upcoming mobile technology like 5G and 6G.Where high speed data accessing should be provided with best secured system.

Here we are providing security system to DDOS attacker, where he keeps server young aged and busy type and not finding server e.t.c such type of attacks where common people cannot identify. After providing good admin security we can eliminate or minimize and control such type of threats.

## LITERATURE SURVEY (REVIEW)

The every research behind the story is literature survey which is important to know the identified problem and various solution and failure. All these problems will solved by referring various papers and Technical discussions.

Paper1 :- By Surendra Kumar Keshari<sup>1,2</sup> · Vineet Kansal<sup>3</sup> · Sumit Kumar<sup>4</sup> .” A Systematic Review of Quality of Services (QoS) in SoftwareDefined Networking (SDN)” Springer Science+Business Media, LLC, part of Springer Nature 2020.

In this paper- identified the SDN environment switches are decoupled with controllers and dump switches. For a large size network, all the controller and switches

are active in networks. To enhance the performance in network the controllers' designs as well as the placements of different controllers are still research issues. In various aspects to enhance the network performance other issues like flexibility, scalability, latency, security and consistency are also important, Research Challenges Based on QoS in SDN While research in SDN is growing the QoS is improving but still SDN deserves more research. Efficient controller placement and reliability of networks are biggest challenge which seeking more research effort. As per survey the research challenges to improve QoS in multiple controllers SDN networks are following: Controllers Security As they know controller is a centrally monitoring and managing device therefore the security and protection



of controller is required from any malicious attack. The malicious attacks may disrupt the control plane and data plane communication and also may be the reason of fault tolerance. Disconnection between data plane and control plane due to fault tolerance may cause the network failure. So the reliability consideration is an important issue among multiple controllers in SDN. So, His telling this is also a research area to develop anti malicious attack mechanism. His concluding that SDN is an attractive research area in today's computer networks communication area. But the challenge in this area is QoS in respect of controller management lading. For the large size network controller deployment is difficult to manage. The reliability and scalability are key challenges for QoS in programmable network. This paper investigates the programmable networks (SDN) overviews and briefed the QoS of SDN in respect of controller' schallenges. SDN gives us the opportunity to solve the research towards Quality of Services. This paper also review and tabulated the available controller's summary. With the help of programmable network the efficiency and throughput of network can be improved. In this survey paper theyhave analyzed the current research and summarized the findings of the different controller's performance based on certain QoS parameters e.g. reliability, scalability, consistency and load balancing. Finally, this paper concludes and highlighted some research challenges that may improve the QoS of SDN.

Pape2 :- Danijel Čabarkapa1, Dejan Rančić2 Petar Pavlović1, Miodrag Milićević1 “INVESTIGATING THE IMPACT OF TREE-BASED NETWORK TOPOLOGY ON THE SDN CONTROLLER PERFORMANCE” FACTA UNIVERSITATIS Series: Automatic Control and Robotics Vol. 21, No 1, 2022, pp. 25 – 35.

On his discussion RYU and ONOS are the two most powerful and widely used SDN controllers. There are many researchers currently working on the evaluation and comparison of these controllers. Both of them have their advantages and disadvantages. His telling This paper can help researchers to choose between the RYU and ONOS in different use cases, especially for data centers and complex Tree-Based network environments with a large number of SDN controllers, switches,

and links. The results of the simulation proved that ONOS performs better than RYU based on selected parameters. In total, the ONOS controller was found to outperform RYU in the proposed Fat-Tree topology environment, especially regarding the throughput, time between packets sent to the end hosts, and response received at the Open Flow switch. More sophisticated embedded ONOS algorithms, distributed architecture, and proactive installation of rules on the whole path that the packet will take, certainly lead to an overwhelming behavior of the ONOS controller in his proposed topology.

This research work opens opportunities for many other research directions. In the future, we plan to keep extending this study with the ONOS cluster multi-controller network environment and with some other SBI APIs. Furthermore, there were different sets of experiments that are left for future research. Some of the variations in experiments that can be conducted in the future to expand the scope of the investigations may include varying the size and/or numbers of the files being communicated. Moreover, it would also be interesting to investigate the results with different sizes of data packets and multi-controller topology in the experiments.

Paper3:- Andrés F. Murillo, Sandra Julieta Rueda, Laura Victoria Morales, and Álvaro A. “SDN and NFV security: challenges for integrated solutions” Springer International Publishing AG 2017.

On his discussion SDN/NFV environments resemble operating system environments, where multiple applications make use of shared resources to achieve their goals. They discussed these similarities and analyzed the security challenges that SDN/NFV have in this area. They presented an extended SDN/NFV architecture that implements a reference monitor and a mandatory access control framework. These components enable applications to run on a shared resource platform, ensuring that access to the Resources follows the policies defined by the administrators. Further work is required to propose algorithms that can properly resolve conflict among policies from different applications. The mechanisms used to limit resource distribution among applications and prioritizing certain applications when resources are scarce will also be developed as future

work. The current proposal regarding authorization does not consider information-flow-based policies, like Biba or MLS. While allow rules enable administrators to assign permissions, on SDN/NFV resources, to applications, they are not enough to forbid flows that are contrary to defined flows, like Biba or MLS policies do because these types of policies require the identification of all possible information flows created by all types of operations allowed in the system, and to detect and deny any possible flow in conflict with Policies. A future challenge is how to extend our architecture to offer enforcement for these types of policies.

Paper4:-Sri Ramu DS1, Radhika SN2 “APPLICATIONS OF 5G IN HEALTHCARE SECTOR” On his discussion he identifies the 5G problems and features of 5g. They are as follows. The 5G technology is providing up to 25 Mbps connectivity speed.

- 5G technology offer high resolution for cell phone user and bi- directional large Bandwidth sharing.
- 5G technology is providing large broadcasting of data in Gigabit which supporting almost 65,000 connections.
- The uploading and downloading speed of 5G technology touching the peak
- The 5G technology also support virtual private network.
- The 5G terminals will have software defined radios and modulation schemes as well as new error-control schemes that can be downloaded from the Internet.
- The development is seen towards the user terminals as a focus of the 5G mobile networks. E.g. The advanced billing interfaces of 5G technology makes it more attractive and effective.
- The 5G technology network offering enhanced and available connectivity just about the world
- The terminals will have access to different wireless technologies at the same time and the terminal should be able to combine different flows from different technologies.
- In 5G, each network will be responsible for handling user-mobility, while the terminal will make the

final choice among different wireless/mobile access network providers for a given service. Such choice will be based on open intelligent middleware in the mobile phone The assumption is that the 5G and subsequent generations of wireless communication technologies will provide service now and in the future with exponentially increasing bandwidth (for data/information flow), decreasing latency.

## CONCLUSION

The works along with research opportunities on the networking aspect of 5G and IoT for smart healthcare and industry We firstly presented an architecture for 5G smart healthcare and the essential techniques (i.e., D2D communication, Small cells, Software-defined network (SDN), Network function virtualization (NFV), mm Waves and Edge computing) to enable 5G smart healthcare. Secondly, we presented the taxonomy of 5G smart healthcare, and analyzed the new requirements (i.e., ultra-low latency, high bandwidth, ultra-high reliability and high battery lifetime) and objectives (optimizations of resources, enhancing QoS, reducing interference and improving energy efficiency) for 5G smart healthcare. Thirdly presented a detailed review of network layer solutions, including scheduling, routing, and congestion control, applied to IoT based 5G smart healthcare covering both recent work and future research opportunities.

## REFERENCES

1. Surendra Kumar Keshari<sup>1,2</sup> · Vineet Kansal<sup>3</sup> · Sumit Kumar<sup>4</sup>.” A Systematic Review of Quality of Services (QoS) in SoftwareDefined Networking (SDN)” Springer Science+Business Media, LLC, part of Springer Nature 2020.
2. Danijel Čabarkapa<sup>1</sup>, Dejan Rančić<sup>2</sup> Petar Pavlović<sup>1</sup>, Miodrag Milićević<sup>1</sup> “INVESTIGATING THE IMPACT OF TREE-BASED NETWORK TOPOLOGY ON THE SDN CONTROLLER PERFORMANCE” FACTA UNIVERSITATIS Series: Automatic Control and Robotics Vol. 21, No 1, 2022, pp. 25 – 35.
3. Andrés F. Murillo, Sandra Julieta Rueda, Laura Victoria Morales, and Álvaro A. “SDN and NFV security: challenges for integrated solutions” Springer International Publishing AG 2017.
4. Sri Ramu D S1, Radhika S N2 “APPLICATIONS OF 5G IN HEALTHCARE SECTOR”

# Implications of Shifting from Competitive to Cooperative Paradigms in Educational Restructuring: A Comprehensive Research Analysis

**Shrikant Bhopale**

✉ shrikant.dypcoes@gmail.com

**Shivani Kale**

✉ dr.shivaanikalle@gmail.com

**Rohit Raut**

**Rajesh Gade**

Associate Professor

CSE(DS) Dept

Dr. D. Y. Patil Pratishthan's College of Engg

Saokhenagar

## ABSTRACT

This paper investigates the potential implications of transposing educational systems from a competitive paradigm focused on individual achievement to a cooperative one emphasizing collaborative learning. Analyzing the impact on curriculum design, assessment practices, teacher roles, and student outcomes, we explore the transformative potential and intricate challenges associated with this shift. In this paper, we investigate the potential implications of a paradigm shift in educational restructuring, moving from the traditional focus on individual achievement and competition to a collaborative approach centered on shared learning. Analyzing the impact on curriculum design, assessment practices, teacher roles, and student outcomes, we explore the transformative potential and intricate challenges associated with this transition.

**KEYWORDS** : *Educational restructuring, Cooperative learning, Curriculum design, Assessment, Teacher roles, Student outcomes, 21st-century skills, Equity, Inclusion.*

## INTRODUCTION

Traditional educational systems have long been dominated by a competitive paradigm, driven by standardized testing and individual rankings. This approach, while fostering academic excellence in some students, has been criticized for exacerbating inequalities, stifling creativity, and promoting unhealthy competition. [18] India is geared up to implement the guidelines of National Education Policy 2020 throughout the country to reform and make radical changes in school education and higher education with an objective of creating a new education system which should empower the youngsters and boost their confidence to create new knowledge, new skills, along with human values to solve current and future problems and challenges of the civilized society by means of their enhanced innovative ability and tech-savviness.

It is known that technology which is an application of scientific thinking has the capabilities to improve the quality of life of everyone in this universe and quality education is the foundation for it. With the objective of providing value based, knowledge based, and skill based higher education for everyone in the country, the new education policy has many intrinsic propositions to improve the quality of school and higher education to creating interest in their chosen area to find challenges and converting them into opportunities by discovering innovative solutions to make life comfortable and successful with expected happiness. In response, a growing movement advocates for a shift towards a cooperative paradigm, where collaboration and shared learning become central to the educational experience. This paper analyzes the potential implications of such a shift in the context of ongoing educational restructuring efforts.

**BENEFITS OF A COOPERATIVE PARADIGM**

Four theoretical perspectives on cooperative learning and achievement are presented: Motivational, Social Cohesion, Cognitive Developmental, and Cognitive Elaboration Perspectives[7].

- **Enhanced Equity and Inclusion:** Collaborative learning environments can level the playing field for students from diverse backgrounds by fostering peer support, accommodating different learning styles, and promoting collective understanding. This aligns with current restructuring goals of increasing access and ensuring inclusive learning experiences for all students. Peer support bridges socio-economic disparities, differentiated instruction caters to individual learning styles, and collective understanding fosters a sense of community. This aligns with restructuring goals of ensuring inclusive and equitable access to quality education for all.
- **Development of 21st-Century Skills:** Collaboration fosters essential skills like critical thinking, problem-solving, communication, and teamwork, crucial for success in the interconnected and collaborative world of the 21st century. This resonates with restructuring efforts aimed at preparing students for future careers and challenges. Critical thinking and problem-solving flourish through group projects, communication hones its voice in shared deliberations, and teamwork finds its rhythm in co-created knowledge. This resonates with restructuring efforts aimed at preparing students for an interconnected and collaborative world.
- **Motivation and Engagement:** Working together on projects and solving problems collaboratively can increase student motivation and engagement, leading to deeper learning and a more positive learning experience. Engaging in collaborative projects and solving problems in tandem fuels deeper learning, replacing the anxieties of competition with the joy of collective achievement. This aligns with restructuring goals seeking to combat disengagement and promote student well-being.

- **Building Positive Learning Environments:** A cooperative culture can foster empathy, respect for diversity, and a sense of community, building a more supportive and inclusive learning environment for all students. A cooperative culture fosters empathy, respect for diversity, and a sense of belonging. Shared learning experiences cultivate social responsibility, emotional intelligence, and a supportive school climate. This aligns with restructuring goals seeking to create positive school climates and promote holistic development.

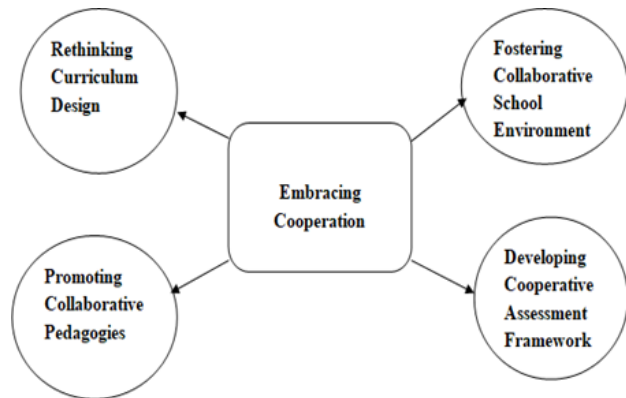

Figure 1. Cooperative Paradigm

**CHALLENGES OF A COOPERATIVE PARADIGM**

- **Curriculum and Assessment Realignment:** Traditional curriculum design often focuses on individual knowledge acquisition and standardized testing, requiring rethinking to integrate collaborative activities and develop assessment methods that evaluate group work and co-created knowledge. Traditional, content-oriented curricula require a transformative dance to integrate collaborative activities. Interdisciplinary modules, community-based initiatives, and group projects need to be choreographed, demanding a rethinking of assessment practices beyond standardized tests to encompass group dynamics, co-created knowledge, and individual contributions.
- **Teacher Training and Support:** Shifting from instructor-centered teaching to facilitating cooperation requires teachers to adopt new pedagogies and have access to adequate training and support in designing and implementing



collaborative learning activities. From the conductor of a solo performance, the teacher in a cooperative classroom becomes the facilitator of an ensemble. New skills in problem-solving, group work orchestration, and peer assessment are paramount. Robust training and support in collaborative pedagogies are crucial for this transformation.

- **Institutional Resistance and Policy Misalignment:** Existing policies and school structures might not be conducive to fostering collaborative learning. Restructuring policies, allocating resources for cooperative initiatives, and promoting knowledge sharing between schools are crucial. Existing policies and school structures, often clinging to the outdated melody of competition, can create a discordant counterpoint to collaborative initiatives. Restructuring policies, allocating resources for collaboration, and promoting knowledge sharing are essential to ensure harmonious implementation.
- **Measuring and Monitoring Progress:** Assessing the effectiveness of cooperative learning requires the development of new metrics that go beyond individual test scores. Focusing on indicators like student engagement, communication skills, and collaborative problem-solving is vital. Assessing the success of collaboration requires moving beyond the single-note test score. New metrics, like student engagement, communication skills, and collaborative problem-solving, need to be developed to accurately capture the symphony of learning in a cooperative environment.

## RECOMMENDATIONS FOR EMBRACING COOPERATION

- **Rethinking Curriculum Design:** Integrate group projects, interdisciplinary learning modules, and community-based initiatives into the curriculum, providing opportunities for collaboration and connecting education to real-world challenges. Reorchestrate the curriculum to include group projects, interdisciplinary modules, and community-based initiatives, providing opportunities for co-creation and connecting education to real-world challenges.
- **Promoting Collaborative Pedagogies:** Teacher

training programs and professional development should emphasize active learning strategies, group work facilitation, and peer assessment methods. Train teachers in the art of facilitating collaboration, equipping them with skills in problem-solving, group work facilitation, and peer assessment. Invest in professional development programs that emphasize collaborative pedagogies.

- **Fostering Collaborative School Environments:** Encourage student leadership, peer mentoring programs, and community partnerships to create a school culture that values collaboration and collective achievement.
- **Developing Cooperative Assessment Frameworks:** Move beyond individual test scores and incorporate group project evaluations, self-reflection exercises, and peer feedback to provide a more holistic picture of student learning within a collaborative context. Move beyond the single-note test score and develop a polyphonic tapestry of assessment methods. Incorporate group project evaluations, self-reflection exercises, and peer feedback to capture the multifaceted nature of collaborative learning.

## CONCLUSION

Shifting from competitive to cooperative paradigms in educational restructuring presents both challenges and opportunities. While concerns about curriculum redesign, assessment methods, and institutional resistance require careful consideration, the potential benefits of collaboration for achieving equity, developing 21st-century skills, and fostering positive learning environments are undeniable. By thoughtfully rethinking curriculum, pedagogies, and assessment, and providing adequate support for teachers and schools, we can leverage the power of cooperation to create a more inclusive, engaging, and future-oriented educational landscape. Shifting from competitive to cooperative paradigms in educational restructuring requires a delicate balance between transformative potential and intricate challenges. While concerns about curriculum redesign, teacher training, and institutional resistance should not be taken lightly, the potential for collaboration to achieve equity, develop 21st-century



skills, and foster positive learning environments remains undeniable.

### FUTURE RESEARCH

- Conducting in-depth case studies of schools successfully implementing cooperative learning approaches to measure their impact on student outcomes and school culture.
- Analyzing specific policy interventions and their role in enabling or hindering the transition to cooperative paradigms.
- Developing and validating robust metrics and frameworks for measuring and monitoring the effectiveness of collaborative learning approaches in achieving educational goals.
- Exploring the potential of technology in facilitating and scaling up collaborative learning experiences across diverse contexts.

### REFERENCES

1. Kohn, A. (2020). The power of not grading. ASCD.
2. Hattie, J. (2018). Visible learning. Corwin.
3. Biesta, G. (2016). Learning democracy: Towards a relational ontology of education. Rowman & Littlefield.
4. Darling-Hammond, L. (2020). A perfect storm: The crisis in education and how the coronavirus makes it worse. Teachers College Press.
5. Johnson, D. W., & Johnson, F. P. (2015). Cooperative learning revisited: New insights for higher education. Routledge.
6. OECD. (2023). Education at a glance. OECD Publishing.
7. Slavin, R. E. (2022). Cooperative learning: Theory, research, and practice. Sage Publications.
8. Dyrud, A. K., & Evjen, R. (2023). Universal design for learning in cooperative learning spaces. SAGE Publications.
9. Ebby, C. G. (2019). Building inclusive classrooms through culturally responsive teaching and cooperative learning. Routledge.
10. Deci, E. L., & Ryan, R. M. (2020). Intrinsic motivation. Guilford Publications.
11. Hmelo-Silver, C. E., & Barrows, H. S. (2023). Facilitating collaborative learning. SAGE Publications.
12. Dweck, C. (2017). Mindset: The new psychology of success. Ballantine Books.
13. Van den Akker, J. (2017). Learning for a sustainable future: The role of emotional intelligence in education. Springer.
14. Biesta, G. (2018). The good school: An education for the common good. John Wiley & Sons.
15. Fullan, M., & Hargreaves, A. (2020). Four fundamental conditions of learning. Corwin.
16. Wiggins, G. P., & McTighe, J. (2019). Understanding by design. ASCD.
17. Creswell, J. W., & Creswell, J. D. (2018). Research design: Qualitative, quantitative, and mixed methods approaches (5th ed.). Sage Publications.
18. Prof. (Dr.) Abhay Kumar, (2022), "Importance Of National Education Policy-2020 In Imparting Education", Journal of Positive School Psychology, Vol. 6, No. 2, 6557-6561.

# Educational Leadership in the 5IR: Nurturing Sustainable Innovators

Nirmale Rekha Laxman

✉ rekhanirmale2107@gmail.com

## ABSTRACT

Educational leadership in the context of the 5th Industrial Revolution (5IR) is pivotal for preparing students to navigate a rapidly changing technological landscape while fostering sustainability and innovation. This abstract outlines the key elements of educational leadership in the 5IR, emphasizing adaptability, technology integration, and the cultivation of sustainable innovators. Leadership strategies encompass promoting adaptability and flexibility within educational institutions, creating a culture that embraces change and continuous learning. The integration of emerging technologies, such as artificial intelligence and augmented reality, into the curriculum is essential, requiring educators to acquire the necessary skills for effective implementation. Cross-disciplinary learning experiences, critical thinking development, and fostering an entrepreneurial mindset contribute to shaping a generation capable of addressing real-world challenges. Leaders emphasize global citizenship, incorporating diverse perspectives and leveraging technology for international collaboration. Ethical considerations play a central role, in guiding students in making responsible decisions within the evolving technological landscape. Despite challenges like adapting traditional education systems, fostering a mindset shift towards lifelong learning, and addressing the digital divide, educational leaders must create relevant, responsive environments aligned with workforce and societal needs. The importance lies in preparing sustainable innovators who balance technological advancement with ethical and environmental considerations. In conclusion, educational leadership not only shapes individual success but also contributes to a more equitable, responsible, and innovative global society in the face of the 5IR.

**KEYWORDS** : *Educational leadership, 5th Industrial Revolution (5IR), Sustainable innovators, Technology integration, Global citizenship.*

## EDUCATIONAL LEADERSHIP

Educational leadership refers to the process of guiding, directing, and influencing individuals or groups within an educational institution. [1] It involves setting a vision, making strategic decisions, fostering a positive learning environment, and promoting the overall success and well-being of students and staff. [2] Educational leaders can be administrators, teachers, or other professionals who play a key role in shaping the educational experience and ensuring effective and equitable learning outcomes.[3]

## EDUCATIONAL LEADERSHIP IN THE 5IR

Educational leadership in the context of the 5th Industrial Revolution (5IR) involves adapting and navigating the challenges and opportunities presented by emerging technologies and changes in the global landscape. Leaders in education during the 5IR focus on preparing students for a rapidly evolving future, emphasizing skills like critical thinking, creativity, adaptability, and digital literacy. [4] They integrate technology into learning strategies, foster innovation,

and collaborate with various stakeholders to ensure education aligns with the demands of the evolving job market and society shaped by the 5IR[5].

### EDUCATIONAL LEADERSHIP IN THE 5IR MEANING

Educational leadership in the 5th Industrial Revolution (5IR) refers to the guidance and direction provided by educational leaders in navigating the transformative challenges brought about by advanced technologies, automation, and global interconnectedness. [4] These leaders are tasked with shaping educational strategies that equip students with the skills necessary for success in a rapidly changing world, emphasizing adaptability, critical thinking, and digital literacy.[6] They play a crucial role in fostering innovation, integrating technology into learning, and creating an environment that prepares students for the demands of the evolving socio-economic landscape driven by the 5IR.[7]

### EDUCATIONAL LEADERSHIP IN THE 5IR: NURTURING SUSTAINABLE INNOVATORS

Educational leadership in the 5th Industrial Revolution (5IR) with a focus on nurturing sustainable innovators involves fostering a learning environment that encourages creativity, critical thinking, and a sense of responsibility toward global challenges. Leaders aim to cultivate a generation of students who not only possess technological skills but also understand the importance of sustainable practices and ethical innovation. This approach involves integrating sustainability principles into the curriculum, promoting interdisciplinary learning, and encouraging students to develop solutions for real-world problems within the framework of a rapidly evolving technological landscape.

#### Adaptability and Flexibility

- Emphasize the importance of adaptability and flexibility in educational leadership to align with the rapidly evolving landscape of the 5IR.
- Encourage leaders to embrace change and instill a culture of continuous learning.

#### Technology Integration

- Prioritize the integration of emerging technologies

like artificial intelligence, blockchain, and augmented reality into the curriculum.

- Equip educators with the necessary skills to leverage technology effectively in teaching and learning processes.

#### Cross-disciplinary Learning

- Promote cross-disciplinary learning experiences to foster a holistic understanding of complex problems and encourage innovative thinking.
- Create collaborative environments that facilitate the exchange of ideas across different fields of study.

#### Critical Thinking and Problem-Solving

- Emphasize the development of critical thinking skills and problem-solving abilities to address real-world challenges posed by the 5IR.
- Encourage educators to design learning experiences that stimulate analytical thinking and creativity.

#### Entrepreneurial Mindset

- Cultivate an entrepreneurial mindset among students, encouraging them to identify opportunities, take risks, and create solutions.
- Integrate entrepreneurship education into the curriculum, providing practical experiences and exposure to entrepreneurial role models. [8]

#### Global Citizenship

- Foster a sense of global citizenship by incorporating global perspectives into the educational framework.
- Use technology to facilitate international collaboration and expose students to diverse cultural perspectives.

#### Ethical Considerations

- Instill a strong sense of ethics and responsibility in the use of technology and innovation.
- Address ethical dilemmas associated with emerging technologies and guide students in making ethically informed decisions.

**Lifelong Learning Culture**

- Establish a culture of lifelong learning, encouraging both educators and students to pursue continuous professional development.
- Provide resources and support for ongoing learning opportunities, adapting to the evolving demands of the 5IR.

**Environmental Sustainability**

- Integrate sustainability principles into the curriculum to raise awareness about environmental challenges.
- Encourage the development of eco-friendly innovations and solutions through project-based learning.

**Collaboration with Industry**

- Forge strong partnerships with industry leaders to align educational programs with the skills and knowledge needed in the workforce.
- Provide students with internships, mentorship programs, and exposure to real-world industry challenges.

**Data Literacy**

- Include data literacy skills in the educational framework to empower students to analyze and interpret data effectively.
- Emphasize the responsible use of data and privacy considerations.

**Continuous Assessment and Feedback**

- Implement continuous assessment methods and provide timely feedback to support students' learning journeys.
- Use data-driven insights to adapt teaching methods and improve educational outcomes.

By incorporating these points into educational leadership strategies, institutions can better prepare students to thrive in the 5IR while fostering a mindset of sustainability and innovation. [9]

**Importance**

Nurturing sustainable innovators through educational

leadership in the 5th Industrial Revolution is crucial for several reasons. Firstly, it addresses the need for individuals who can navigate and contribute to a rapidly changing technological landscape while being mindful of environmental and social impacts. Secondly, by integrating sustainability into education, leaders promote a holistic approach that aligns with global concerns, fostering responsible citizenship. Additionally, cultivating sustainable innovators prepares students to tackle complex challenges, encouraging them to develop solutions that balance technological advancement with ethical and environmental considerations, contributing to a more sustainable and equitable future. [10-11]

**Need**

Educational leadership in the Fifth Industrial Revolution (5IR) involves fostering sustainable innovators by emphasizing critical thinking, adaptability, and interdisciplinary skills. Leaders should promote a curriculum that integrates emerging technologies, encourages collaboration, and addresses global challenges, preparing students to navigate the rapidly evolving landscape of the digital era. [11-12]

**Challenges**

Challenges in nurturing sustainable innovators in the 5IR include adapting traditional education systems to incorporate cutting-edge technologies, fostering a mindset shift towards lifelong learning, addressing the digital divide, and ensuring that curricula are relevant and responsive to the evolving needs of the workforce and society. Additionally, leaders face the task of equipping educators with the necessary skills to guide students in developing a strong foundation in critical thinking, creativity, and ethical decision-making. [11,13]

**Fact**

A crucial fact in educational leadership for nurturing sustainable innovators in the Fifth Industrial Revolution is the recognition that fostering adaptability, resilience, and a commitment to lifelong learning is as vital as imparting specific technical skills. This holistic approach prepares students to navigate the complexities of the 5IR, where innovation is not just about technology but also about sustainability, ethical considerations, and a global perspective. [13-14]

Key issues related to nurturing sustainable innovators in the 5IR:

Industrial Revolution (5IR) involves addressing various challenges and opportunities associated with the rapidly evolving technological landscape. Here are some

Educational leadership in the context of the Fifth

Sr No.	Issues	Challenge	Opportunity
1	Technological Integration	The integration of emerging technologies such as artificial intelligence, blockchain, and the Internet of Things into the educational system can be complex	Educational leaders need to facilitate the seamless integration of these technologies to enhance the learning experience and prepare students for the future job market
2	Curriculum Relevance	Traditional curricula may not keep pace with the rapidly changing skill requirements in the 5IR.	Educational leaders should work towards developing and updating curricula that are relevant, flexible, and aligned with the demands of the 5IR, focusing on critical thinking, problem-solving, and adaptability.
3	Inclusive Education	The digital divide can exacerbate existing inequalities, limiting access to technology and quality education for certain groups.	Leaders must promote inclusive practices, ensuring that all students, regardless of socio-economic background, have access to the necessary tools and resources for 5IR skills development.
4	Teacher Professional Development	Many educators may not be adequately equipped to teach 5IR-related concepts and skills.	Educational leaders should invest in ongoing professional development programs to empower teachers with the knowledge and skills needed to effectively incorporate technology into their teaching methods.
5	Critical Thinking and Creativity	The emphasis on standardized testing may hinder the development of critical thinking and creativity.	Leaders should advocate for educational approaches that prioritize critical thinking, creativity, and innovation, fostering a mindset that encourages students to question, explore, and create.
6	Ethical and Responsible Technology Use	The 5IR brings ethical concerns related to data privacy, security, and the responsible use of technology.	Leaders must instill a sense of ethical responsibility in students, promoting awareness of the potential societal impacts of technology and encouraging the development of ethical innovators.
7	Global Collaboration	Educational systems may be too localized, hindering global collaboration and exposure to diverse perspectives.	Leaders should promote international collaboration, leveraging technology to connect students with peers from different parts of the world, fostering a global perspective and preparing them for a globally interconnected workforce.
8	Lifelong Learning Culture	The pace of technological change requires individuals to adopt a lifelong learning mindset.	Leaders should cultivate a culture of continuous learning, encouraging both students and educators to embrace ongoing skill development and adaptability throughout their lives.



In addressing these issues, educational leaders play a crucial role in preparing students to thrive in the 5IR by fostering innovation, resilience, and a commitment to lifelong learning. [10,13]

**Educational Leadership in the 5IR: Nurturing Sustainable Innovators: Remedies**

To effectively nurture sustainable innovators in the context of the Fifth Industrial Revolution (5IR), educational leaders can implement various remedies. Here are practical strategies to address the challenges and foster an environment conducive to the development of innovative and sustainable skills:

Sr. No	Challenges	Remedy
1	Strategic Technology Integration	Develop a comprehensive technology integration plan that aligns with educational goals. Provide professional development opportunities for educators to enhance their digital literacy and incorporate emerging technologies into the curriculum.
2	Flexible and Adaptive Curricula	Foster curriculum flexibility by regularly reviewing and updating content to align with 5IR skills. Encourage interdisciplinary approaches, project-based learning, and real-world problem-solving to enhance adaptability and creativity
3	Equitable Access to Technology	Implement initiatives to bridge the digital divide, ensuring that all students have access to technology. This may involve providing devices, internet connectivity, and technology training to underserved communities.
4	Continuous Professional Development	Establish ongoing professional development programs that focus on 5IR-related skills for educators. Encourage collaboration and peer learning to create a supportive environment for skill enhancement.

5	Promotion of Critical Thinking and Creativity	Design assessments that emphasize critical thinking, problem-solving, and creativity. Provide resources and training for teachers to integrate inquiry-based learning approaches that stimulate curiosity and innovation.
6	Ethics Education and Responsible Tech Use	Incorporate ethics education into the curriculum to address the responsible use of technology. Create discussions around data privacy, cybersecurity, and the ethical implications of emerging technologies.
7	Global Collaboration Initiatives	Foster partnerships with schools and institutions globally. Implement virtual exchange programs, collaborative projects, and joint initiatives to expose students to diverse perspectives and develop a global mindset.
8	Cultivation of a Lifelong Learning Culture	Instill a culture of continuous learning by integrating lifelong learning skills into the curriculum. Encourage students to pursue interests beyond the standard curriculum and provide opportunities for self-directed learning.
9	Entrepreneurship and Innovation Programs	Establish entrepreneurship and innovation programs that encourage students to develop and implement their ideas. Provide mentorship, incubator spaces, and connections to industry experts to support the development of innovative projects.
10	Community Engagement and Partnerships	Engage with the local community, businesses, and industries to align education with real-world needs. Create internship programs, apprenticeships, and mentorship opportunities to connect students with professionals in relevant fields.

11	Assessment and Recognition of 5IR Skills	Reevaluate assessment methods to measure 5IR skills effectively. Consider alternative assessment formats such as portfolios, presentations, and project-based assessments that showcase practical application of skills.
12	Policy Advocacy and Leadership Development	Advocate for policy changes that support 5IR education. Invest in leadership development programs for educators to empower them to drive innovation within their schools and districts.

By implementing these remedies, educational leaders can create a dynamic and responsive learning environment that equips students with the skills needed to thrive in the 5IR and contribute to sustainable innovation. [11,10,15]

**IMPORTANCE FOR FUTURE ASPECTS**

Educational leadership in nurturing sustainable innovators is essential for future aspects as it cultivates a generation capable of addressing global challenges with creativity and ethical awareness. By instilling a mindset of continuous learning and adaptability, leaders contribute to a workforce ready to embrace evolving technologies and navigate the complexities of the 5IR. This approach not only prepares individuals for career success but also fosters responsible and innovative contributors to a sustainable and interconnected world. [16-17]

**CONCLUSION**

Educational leadership in the 5th Industrial Revolution is paramount for cultivating sustainable innovators. Leaders must prioritize adaptability, integrate emerging technologies, and foster a culture of continuous learning. By addressing challenges such as the digital divide and curriculum relevance, educational leaders contribute to a generation capable of navigating a dynamic technological landscape ethically. The importance lies not only in preparing individuals for career success but also in shaping responsible contributors to a sustainable and interconnected global society. Despite challenges,

effective leadership ensures that education aligns with the evolving needs of the 5IR, creating a pathway to a more equitable and innovative future.

**REFERENCES**

1. Manuel, J. (2022). Educational Leadership.
2. World Health Organization. (2003). Creating an environment for emotional and social well-being: an important responsibility of a health-promoting and child- friendly school. World Health Organization.
3. Jacobs, J., Beck, B., & Crowell, L. (2014). Teacher leaders as equity-centered change agents: Exploring the conditions that influence navigating change to promote educational equity. *Professional development in education*, 40(4), 576- 596.
4. Barrot, J. S. (2022). Curriculum 5.0 for the Twenty-First Century Higher Education: A Way to Move Forward. In *International Handbook on Education Development in Asia-Pacific* (pp. 1-15). Singapore: Springer Nature Singapore.
5. Samuel, O. M., & Moagi, T. (2022). The emerging work system and strategy for skills transition in South Africa. *Management Research Review*, 45(11), 1503-1523.
6. Luna Scott, C. (2015). The futures of learning 2: What kind of learning for the 21st century?
7. Badran, I. (2020). Higher-Education Governance: A Futuristic Outlook. In *Higher Education in the Arab World: Government and Governance* (pp. 321-344). Cham: Springer International Publishing.
8. Penaluna, A., & Penaluna, K. (2021). In search of entrepreneurial competencies: Peripheral vision and multidisciplinary inspiration. *Industry and Higher Education*, 35(4), 471-484.
9. Yanniris, C. (2021). Education for sustainability, peace, and global citizenship: An integrative approach. *Education Sciences*, 11(8), 430.
10. Viljoen, J. P., & Viljoen, R. (2021). Embracing Industrial Revolutions.
11. Ramakrishna, S. FOURTH INDUSTRIAL REVOLUTION TECHNOLOGIES FOR PROGRESS IN UN SDGS.

12. Lang, J. (2023). Workforce upskilling: can universities meet the challenges of lifelong learning? *The International Journal of Information and Learning Technology*.
13. Khajarian, A., Angell, L. C., & Batra, A. (2023). Higher education, skill development, and the evolving graduate employability landscape in the United Arab Emirates. In *Sustainable and Dynamic Graduate Employability* (pp. 45-70). Routledge India.
14. Khare, M. (Ed.). (2023). *Sustainable and Dynamic Graduate Employability: A Comparative Overview Across Geographies*.
15. Van Deventer, A. (2021). *Teacher engagement with the process in Design: policies, problems, and visions* (Doctoral dissertation, University of Pretoria (South Africa)).
16. Wheeler, K. A., & Bijur, A. P. (Eds.). (2000). *Education for a sustainable future: a paradigm of hope for the 21st century* (Vol. 7). Springer Science & Business Media.
17. Abulibdeh, A., Zaidan, E., & Abulibdeh, R. (2024). Navigating the confluence of artificial intelligence and education for sustainable development in the era of industry 4.0: Challenges, opportunities, and ethical dimensions. *Journal of Cleaner Production*, 140527.

# Rankala Lake Water Pollution Physico-chemical Analysis and Remedies

Monica Shinde

✉ monicaofficial.2021@gmail.com

Harshada Vibhute

Dr. D. Y. Patil Pratishthan's College of Engineering  
Salokhenagar, Kolhapur, Maharashtra

## ABSTRACT

Rankala Lake water is now on the radar of pollution because of the many foreign activities which hampers the quality of lake water. The pollution leads to algal growth and eutrophication which adversely affects the aquatic life. The lake is originally used to supply Kolhapur City with drinking water, the lake is now only used for leisure and agriculture. Locals and tourists alike now take pleasure in having picnics at the lake. Due to the lake's central city location, which draws several sewage terminals that discharge sewage into the lake and encourage the growth of aquatic weeds, the lake is severely contaminated. In order to determine the extent of pollution, lake water is extracted and subjected to physico-chemical examination. This process reveals that the majority of the water is becoming contaminated, necessitating ongoing treatment. One cutting-edge and useful technology that is recommended to reduce lake water pollution is the Lake Water Fountain (LWF).

**KEYWORDS** : *Lake water, Pollution, Physico-chemical, Contamination, Lake water fountain (LWF).*

## INTRODUCTION

The Rankala Lake spans 107 hectares in total, with a fan-shaped catchment area of 700 hectares and a depth of 15 m. Its total capacity is 4350.14 ML [8]. On the surface of the globe, freshwater makes up about 2.5 percent, of which only 1 percent is usable. Lakes, which contribute roughly 0.3% of all surface water body sources, are among the most significant water resources in this context. They have been utilized as a source of water for human consumption. As a result of the growing anthropogenic activity around lakes, their conditions have been steadily declining [10]. Long-term degradation of big lakes has left a legacy of ecological and financial costs for future generations, as well as significant problems for management and restoration. In a warmer, more populous future, larger lakes will need more intensive conservation measures to maintain sustainable, high-quality waters. The opportunity presented by this Warning to Humanity is also to emphasize the importance of establishing a long-term network of lake observatories to track and document environmental changes in sizable lake ecosystems [7].

Pollution problem of Rankala Lake is increasing day by day because of increased population and introduction of foreign flows. The levels of pollution are varying with respect to various seasons of the year and also based on climatic conditions. The lake is regarded as somewhat contaminated, which encourages the growth of water weeds such as *Eichhornia crassipes* [11]. The lake is currently only utilized for irrigation and leisure, but it was once used to supply Kolhapur City with drinking water. Nowadays, both locals and visitors enjoy picnicking at the lake. The lake is extremely polluted due to its central city location, which attracts a lot of sewage terminals that release sewage into the lake, causing aquatic weeds to grow [1]. The nature of flows which are adding to the lake water is quiet polluting and this is being introduced in both ways i.e, inflows and surface flows. Being a lake the water is stagnant and as there are no water velocities are available the self-purification of lake water is not happening. Wind velocities floating on the surface of water introduces turbulence in water which adds air oxygen in the lake water. Even while public access to the majority of lakes is banned, people

frequently disregard this limitation and utilize the water for other purposes, such as irrigation, animal washing, the emission of Ganesh idols, etc. The lake is becoming severely contaminated as a result of human activity affecting its biodiversity [9]. Lack and poor quality of water are two of the worst issues that humanity has ever faced. India is not an exception to this global problem; for many years, it has been plagued by severe water scarcity and pollution [12]. Because of pollution of the lake water due to anthropogenic activities its effects on aquatic plants and animals, the disposal of raw wastewater may have detrimental sanitary effects [3]. Due to the various environmental factors, the standard of water quality can vary significantly and can even be positively or negatively impacted by an unbalanced ecosystem [6].



Fig.1: Google map image of Rankala Lake

Because of the above reasons the several dead fishes are found floating on the surface frequently and this problem is increasing. A rotten foul smell now hangs in the air and it has now spread to Sandhya Math area. The tourists as well as local residents are quite upset because of these developments [13].

**MATERIAL & METHOD**

On the account of this above problem our institute has taken this social initiative to analyse the lake water and study the pollution problem in detail. For this the institute Civil Engineering department constituted a committee. The team decided to go with sampling at every three months to get the clear picture of Rankala Lake Pollution throughout the year. So that the remedial measures can be suggested on larger scale. For this first there is need of analysis of lake water sample, so for analysis we take lake water on 3/6/23 at 11.00 am, then after rainy season on 27/9/2023 at 11.00am and lastly at the middle of winter season on 30/12/2023 at 11.00am. from the point Sandhya Math area. The samples collected from the area of Sandhya math because at this point many of the nallas reaches to lake water also many anthropogenic interactions leading to the most of pollution problems.

The sample is tested in our Environmental Engineering Laboratory and results we got as follows:

**Table 1: Water quality analysis of Rankala Lake**

Note: DO Dissolved Oxygen), BOD (Biochemical Oxygen Demand), TS (Total Solids), TSS (Total Suspended Solids), TDS (Total Dissolved Solids).

**Result & Discussion**

Sr. No.	Parameters	BIS Standard Units	Summer Season	After Rainy Season	Winter Season
1	pH	6.5-8.5	8.94	9.35	9.20
2	Alkalinity (mg/l)	120	160	205	182
3	DO(mg/l)	5	5.9	6.2	6.5
4	BOD (mg/l)	5	22.5	56	62
5	TS(mg/l)	500	233	388	396
6	TSS(mg/l)	250	174	256	220
7	TDS(mg/l)	250	59	132	176
8	Hardness(mg/l)	75	46	125	174
9	Chlorides(mg/l)	250	61	75	72



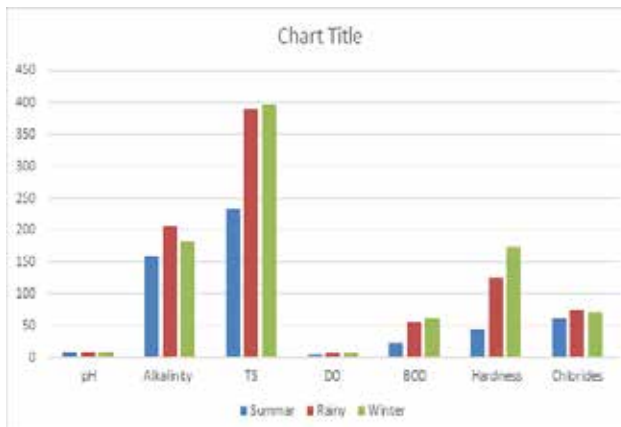

Based on the preceding table, the lake water is deemed to be contaminated. A significant portion of the metrics exceed the BIS safety limits. The bulk of issues can be caused by pH values that are closer to neutral. The water's levels of BOD, hardness, solids, and alkalinity are all over permitted limits when compared to BIS regulations. Furthermore, as a result of seasonal variations, the water's quality is changing and becoming increasingly contaminated throughout the wet seasons. Alkalinity, hardness, and total solids concentrations are higher in the winter months, and the lake water also exhibits pollution-related behavior. Therefore, in order to prevent catastrophes like this one, significant corrective action must be taken.

## REMEDIAL ACTION

With respect to above findings study found that there is need of continuous Dissolved Oxygen engagement with lake water to minimize pollution. So by introducing Lake Fountain Aeration system of suitable capacities in five to six different locations over Rankala Lake can help to overcome the problem because of the following benefits:

This study is focusing on installing a lake fountain aeration system (LFAS) and integrated floating treatment wetlands (FTWs) in order to increase ecological conservation and improve lake water quality [5]. Lake and pond aeration systems induce circulation and add dissolved oxygen throughout the waterbody, helping to mitigate the damage caused by excessive nutrient loading. Floating fountain aerators are visually pleasing additions to any waterbody that offer localized lake aeration and work great for shallow symmetrically

shaped lakes and ponds. Submersed aeration systems release oxygen directly into the water column at precise locations, and work extremely well for circulating large areas of water and increasing oxygen levels in deeper waterbodies, this will leads to the biodegradation process and ultimately helps to minimize BOD levels. Also this technology gives neutralized ranges of pH because of stabilization of concentrated contaminants with respect to DO additions.

## REFERENCES

1. Abhijeet Ghone, Sunil Singhal, (2015). Performance Evaluation of Dewatering Operations Implemented For Conservation of Rankala Lake, Kolhapur, European Academic Research Vol. II, Issue 11.
2. American Public Health Association Standard Methods for Water Quality Analysis.
3. Al-Afify, A.D.G., Abdo, M.H., Othman, A.A. et al. (2023). Water Quality and Microbiological Assessment of Burullus Lake and Its Surrounding Drains. *Water Air & Soil Pollution* vol. 234, 385.
4. Bureau of Indian Standards (BIS) for drinking water quality (2020).
5. Henny, Cynthia & Jasalesmana, Taofik & Kurniawan, Riky & Melati, I & Suryono, T & Susanti, Evi & Pratama Yoga, Gunawan & Rosidah, & Sudiono, BT. (2020). The effectiveness of integrated floating treatment wetlands (FTWs) and lake fountain aeration systems (LFAS) in improving the landscape ecology and water quality of a eutrophic lake in Indonesia. *IOP Conference Series: Earth and Environmental Science*. 535. 012018. 10.1088/1755-1315/535/1/012018.
6. Husain, Intazar & Uddin, Salah. (2020). Analysis of Katraj Lake Water in Pune Region of Maharashtra, India.
7. Jean-Philippe Jenny, Orlane Anneville, et al. (2020). Warning to Humanity: Rapid degradation of the world's large lakes, *Journal of Great Lakes Research*, Volume 46, Issue
8. Kolhapur Municipal Corporation (KMC). "Environmental status report (2015–2016)".
9. Mr. Ketan T. Gejage, Mr. S. M. Bhosale, Dr. H. P. Salunkhe, (2023). Lake Water Quality Monitoring, A Comparative Review and Future Direction: Kolhapur city, *International Journal for Research Trends and Innovation*, Volume 8, Issue 12.

10. Prachi Vasistha, Rajiv Ganguly, (2020). Water quality assessment of natural lakes and its importance: An overview, Materials Today: Proceedings, Volume 32, Part 4.
11. Rasool, S. & Harakishore, K. & Satyakala, M. & Murty, U.S.. (2003). Studies on the physico-chemical parameters of Rankala Lake, Kolhapur. Indian Journal of Environmental Protection. 23. 961-963.
12. Xiuming Sun, Daniel Rosado, Georg Hörmann, Zhenyu Zhang, Lukas Loose, Indumathi Nambi, Nicola Fohrer, (2023). Assessment of seasonal and spatial water quality variation in a cascading lake system in Chennai, India, Science of The Total Environment, Volume 858, Part 3.
13. [http://timesofindia.indiatimes.com/articleshow/100616068.cms?utm\\_source=contentofinterest&utm\\_medium=text&utm\\_campaign=cppst](http://timesofindia.indiatimes.com/articleshow/100616068.cms?utm_source=contentofinterest&utm_medium=text&utm_campaign=cppst).

# Predictive Mechanism for fault-detection in Electric Vehicles: A Sustainable Transport

Uttam S Satpute

✉ uttamsatpute@gmail.com

Suresh D. Mane

✉ mane.suresh@gmail.com

S. S. Deshpande

✉ ssd.manju@gmail.com

Dr. D. Y. Patil Pratishthan's College of Engineering  
Salokhenagar, Kolhapur, Maharashtra

## ABSTRACT

The role of transport in sustainable development has been recognized globally. The anchor points for sustainable transport, in the context of infrastructure, public transport systems, good delivery networks, affordability, efficiency, and convenience of transportation, as well as improving urban air quality and health, and greenhouse gas emissions have been discussed at the global platform – Sustainable Development Summit. This has led to the promotion of Electric Vehicles (EVs) as a sustainable and environmentally friendly means of transportation in the recent past. The Indian Government has set a target of 30 percent electrification of the country's vehicles by 2030. As EV technology progresses, it has become more and more important to ensure the reliability and performance of electric vehicle systems. In point of view safety of Electrical Vehicles with an average of 16 EV and hybrid fires per year, there is a 1 in 38000 chance of fire. The reliability and protection of EV systems are of prime importance. A comprehensive study of predictive modeling and analysis for EV fault finding has been carried out in this paper. The work focuses on the development of a Simulink model of EV system for data collection under different defined faults and study the pattern and predict the fault using machine learning algorithms. Support Vector Machine (SVM), Random Forest, One-vs-Rest (OvR), and Stochastic Gradient Descent (SGD) have been used for the prediction of fault. The result illustrates how predictive analysis may be successfully applied to problem detection and diagnosis highlighting its potential to improve the safety and effectiveness of EV systems.

**KEYWORDS:** Sustainable development goals, Electric vehicles, Predictive analysis, Machine learning algorithms.

## INTRODUCTION

The Sustainable Development Goals (SDGs) adopted by all United Nations Members in 2015 provide a plan for peace and prosperity for people and the planet. The SDGs encompass 17 goals that are urgent for action by all countries. They recognize that health and education must be improved, reduce inequality, and limb economic growth provided tackling climate change and preserve our oceans and forests (<https://sdgs.un.org/goals>).

India is acute in defining the success of the SDGs. At the UN Sustainable Development Summit in 2015, Prime Minister Narendra Modi noted, “Sustainable

development of one-sixth of humanity will be of great consequence to the world and our beautiful planet. It will be a world of fewer challenges and greater hope; and, more confident of its success”. NITI Aayog has been entrusted with coordinating the SDGs, planning schemes related to the SDGs and fixing targets, and ascertaining ministries for each target. In addition, the Ministry of Statistics and Programme Implementation (MoSPI) has been developing national indicators for the SDGs (<https://india.un.org/en/sdgs>).

The use of EVs is one of the means to attain sustainable transport i.e. one of the SGDs' goals. The Indian government has set a target of 30% of electrification by 2030. In recent times EV technology has been

progressing at an exponential rate. As EV technology advances, it becomes imperative to guarantee the security and reliability of electric vehicle systems. To correctly anticipate and perceive failures in EV components is a crucial factor in this respect.

Methods for predictive analysis provide hopeful ways to identify possible faults in advance, allowing preemptive maintenance and raising the safety and effectiveness of EV operations. This paper aims to investigate the use of predictive analysis for fault detection in electric vehicles.

The application of machine learning techniques for predictive fault analysis has been studied by most of researchers (Y. Sun et al., 2019, M. Kalycioglu et al., 2020). Their work displays how well the technique works for detecting issues with electric vehicle systems. (M.

Kalycioglu et al., 2020) compared the various machine learning techniques to defect and diagnose electric vehicle engines. A fault detection technique in electric battery management system packs using adaptive LASSO and support vector machines (SVM) is also proposed by (Wang, L. Liu et al., 2019). In addition, (B. Li, L. Yu et al., 2018) define an unsupervised learning approach for diagnosing electric vehicle faults. Also, (K. Krishnamurthy, V. Devi et al., 2012) propose a hybrid deep learning technique for diagnostics in electric car batteries. Contributions to the field of diagnosis of electric vehicle faults have been also made by (Wen, W. Xie et al., 2019, S Liu et al., 2018). A diagnostic technique based on correlation analysis and a dynamic clustering algorithm for electric vehicle failures is presented in (Xu, Z. Wei et al., 2019). (Y. Liu et al., 2021, Huang et al., 2021) displays on failure prediction and diagnostics of electric vehicle batteries using machine learning algorithms.

The paper intends to add information that is developing in the arena of fault diagnosis for electric vehicles. More precisely the paper presents the development of a Simulink model of EV system for data collection under different defined faults and studies the pattern and predict the fault using machine learning algorithms. Support Vector Machine (SVM), Random Forest, One-vs-Rest (OvR), and Stochastic Gradient Descent (SGD) have been used for the prediction of fault. The results of

this study help to develop proactive maintenance plans for electric vehicles, which would eventually increase their dependability and driving pleasure.

## METHODOLOGY

### Data Collection

Here data indicates the condition of the vehicle over a long period before the fault.

Sensors, onboard diagnostic systems, and maintenance logs are just a few of the places where data on electric vehicles can be gathered. Voltage, current, temperature, and operational circumstances are only a few of the many characteristics covered by the data. The data can be collected through experiments on EV but in this paper simulation data has been adopted. For that, a Simulink model of EV in MATLAB has been developed and data is collected through various sensors such as voltage, current, temperature, velocity, slip, etc.

The simulation model has been developed for a 4-wheeler electric vehicle with the specifications given in Table 1.

**Table 1: Specification of Electric Vehicle**

SL No.	Block	Parameters	Settings
1	Vehicle	Mass	600kg
		Number of wheels per axle	2
		Horizontal distance from CG to	1.4m
		Horizontal distance from CG to rear	1.6m
		CG height above ground	0.5m
2	Tire	Rated vertical load	3000N
		Peak longitudinal at rated load	3500N
		Slip at peak force at rated load	10
3	Differential	Crown gear located	To the right of centerline
		Center to driveshaft teeth ratio	4

4	H Bridge	Power supply	Internal
		Simulation mode	Averaged
		Regenerative breaking	Depends on REV flag and
		Load current characteristics	Smooth
5	Simple gear	Follower to base teeth ratio	2
		Outer shaft rotates	In the same direction as
6	Longitudinal	Control type	PI
7	DC motor	Armature inductance	12μH
		No load speed	14000rpm
		Rated load	50kW
		Rated DC voltage	50V
8	Controlled PWM	PWM frequency	1000Hz
9	Battery	Nominal voltage	50V
		Rated capacity	50Ah
		Initial state of charge	100%
		Battery response time	30 sec

conditions and data obtained after 400 sec represents abnormal conditions.

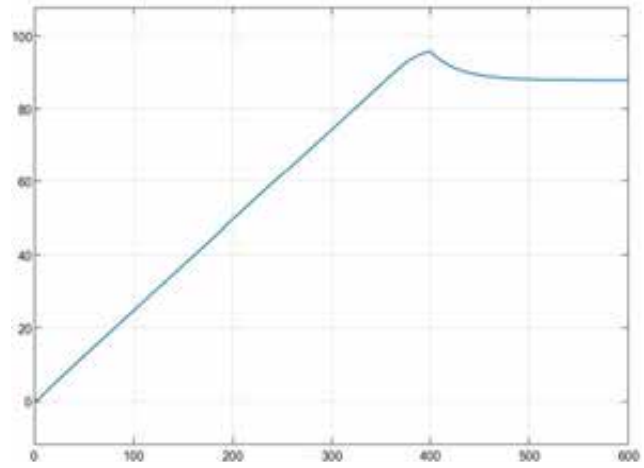

(a)-Velocity

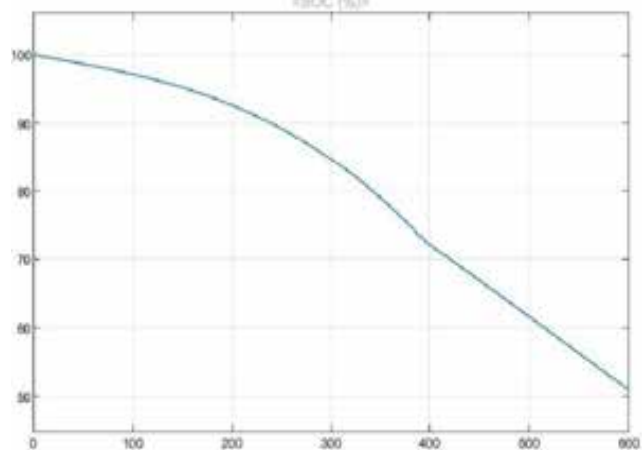

(b) - SOC

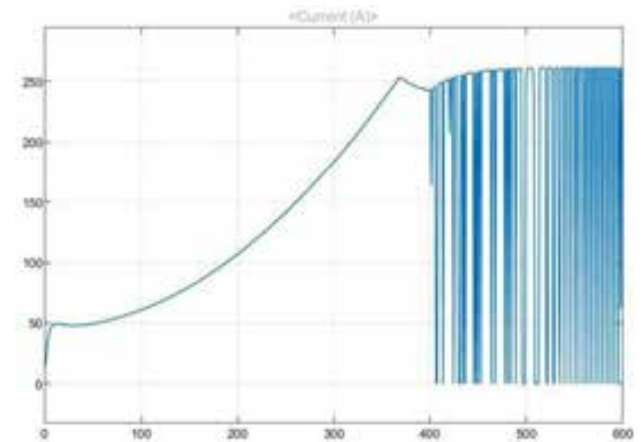

(c)-Voltage

The Simulink model is shown in Figure 1.

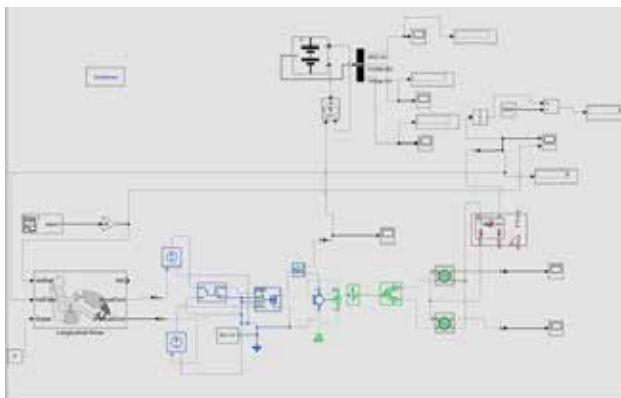

**Figure 1: Simulation Model of Electric Vehicle**

The vehicle velocity, battery current, voltage, state of charge (SOC), and tire slip have been recorded for the armature winding open fault that is introduced at 400sec from the start of the vehicle as shown in Figure 2(a) to 2(f). The data up to 400 sec represents normal



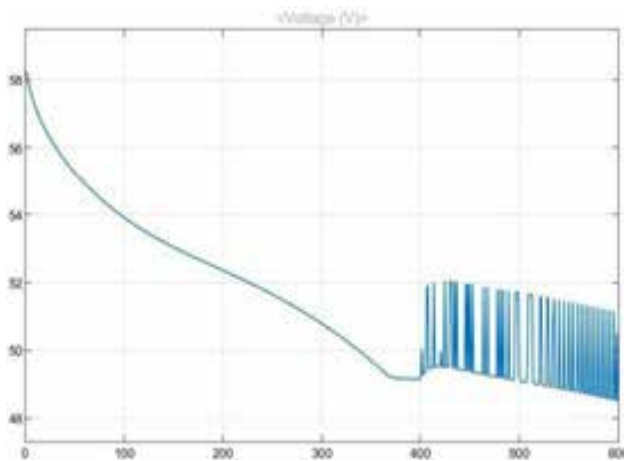

(d)-Current

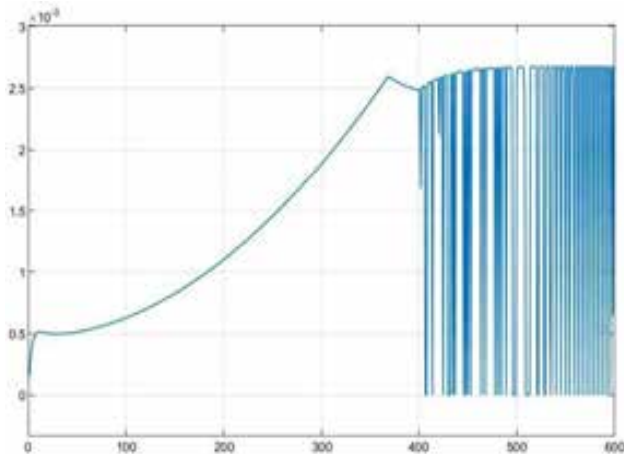

(e)-Slip 1

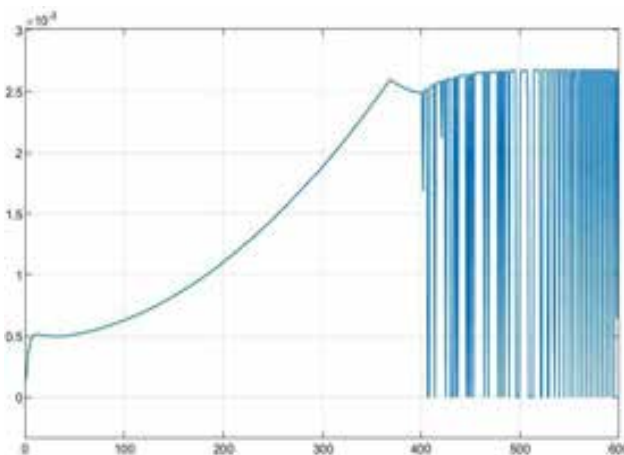

(f)- Slip 2

Figure 2: Sensor output: velocity, SOC, voltage, current, slip

## MACHINE LEARNING SYSTEM

The set of data obtained from the sensors provides the symptom of a particular type of fault that is likely to occur. The objective of the machine learning algorithm is then to identify the type of fault based on the given instant of data. The problem is merely classifying the fault and it can be accomplished through classification algorithms such as Support Vector Machine (SVM), Random Forest, One-vs-Rest (OvR), and Stochastic Gradient Descent (SGD), etc.

## DATA VISUALISATION AND PREPARATION

There is a big list of probable faults: motor failure, motor controller failure, failure between motor controller and motor lines, motor power supply failure, and motor communication failure.

As previously discussed in data collection, in this paper only armature winding open fault has been considered to establish the concept of fault detection and diagnosis. Table 2 gives the statistics of data obtained for armature winding open fault.

Table 2: Statistics of armature winding fault data

	Velocity	Current	SOC	Tout	Voltage
Count	600.00	600.00	600.00	600.00	600.00
Mean	65.5	148.72	80.78	202.16	51.55
Std	33.29	91.42	15.46	148.49	2.31
Min	0.24	0.00262	50.94	0.00	48.50
25%	37.49	61.60	66.95	53.75	49.34
50%	74.50	142.58	84.71	203.50	51.41
75%	100.00	249.193	95.23	353.25	53.02
max	100.00	261.53	99.99	400.100	58.25

Because the data has been obtained through simulation, there are no missing data or outliers, so data cleaning is not required. Similarly, there is no necessity for any sort of standardization because all the sensor output values are in close range.

## IMPLEMENTATION OF MACHINE LEARNING ALGORITHMS AND RESULTS

In this paper only two sets of data have been considered: one corresponding to normal conditions and another

related to abnormal conditions i.e. armature winding open fault. So the problem is an example of a binary classifier. Support Vector Machine (SVM), Random Forest, One-vs-Rest (OvR), and Stochastic Gradient Descent (SGD) have been implemented.

The SGD is capable of handling very large datasets efficiently. It deals with training instances independently, one at a time, which also makes SGD more suitable for online learning. All the algorithms are implemented using Scikit-Learn in the ANACONDA integrated development environment. The classes used include: SGDClassifier, RandomForestClassifier, SupportMachineClassifier, and OneVsRestClassifier. The Random Forest and One-v/s-Rest are capable of handling multiclass natively and can be effectively used if all the faults are considered. The prediction accuracy is obtained as shown in Figure 3.

**Figure 3: Prediction accuracy of machine learning algorithms**

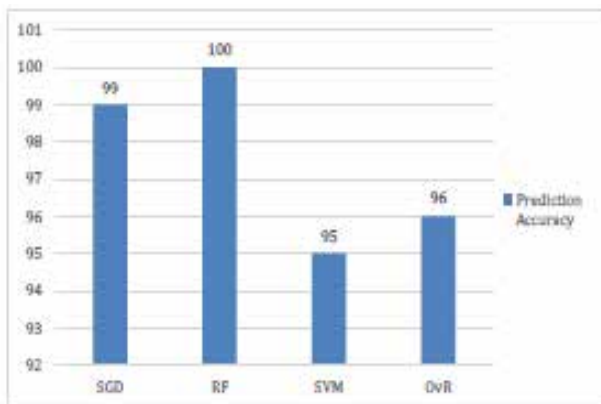

It can be seen that the SGD and RF algorithm gives better predictions. The RF gives 100% result, it is suitable for the present problem because it uses the prediction probability method for classification.

## CONCLUSIONS

The paper has presented a predictive mechanism for fault detection in electric vehicles using machine learning. The data indicating the symptoms of the fault has been obtained through simulation which is the novelty of the paper. Various supervised classification machine learning algorithms have been presented for predicting the fault. The result indicates that Random Forest gives better results because of its inherent capability. The

study helps to develop proactive maintenance plans for electric vehicles, which would eventually increase their dependability and driving pleasure. The present work can be extended by including all other probable faults and implementing other advanced machine-learning algorithms. Moreover, the fault data can be obtained from actual sensors employed in electric vehicles.

## REFERENCES

1. Y. Sun, Y. Zhang, and Y. Wang, "Predictive Fault Analysis of Electric Vehicle Based on Machine Learning" 2019 IEEE International Conference on Applied System Innovation (ICASI), 2019, pp. 1-5, doi: 10.1109/ICASI.2019.8724005.
2. M. Kalaycioglu and M. Yildirim, "A comparative study of machine learning algorithms for fault diagnosis in electric vehicle powertrains" 2020 10th International Conference on Power Electronics and Drive Systems (PEDS), 2020, pp. 586-590, doi: 10.1109/PEDS49568.2020.9212216.
3. Wang, L. Liu, and X. He, "Fault Diagnosis of Electric Vehicle Battery Pack Based on Adaptive LASSO and SVM" 2019 IEEE 3rd International Conference on Intelligent Transportation Engineering (ICITE), 2019, pp. 10-15, doi : 10.1109/ICITE.2019.00007.
4. B. Li, L. Yu, and L. Guo, "A novel method for electric vehicle fault diagnosis based on unsupervised learning" 2018 IEEE Transportation Electrification Conference and Expo (ITEC), 2018, pp. 263-267, doi: 10.1109/ITEC.2018.8450091.
5. K. Krishnamurthy, V. Devi, R. Balaji, and N. K. Goyal, "A Hybrid Deep Learning Model for Fault Prediction and Diagnosis in Electric Vehicle Batteries" 2021 International Conference on Communication and Signal Processing (ICCS), 2021, pp. 0174- 0179, doi: 10.1109/ICCS51398.2021.9413303.
6. Wen, W. Xie, Y. Wang, X. Xie and H. Xie, "Fault Diagnosis and Prognosis of Electric Vehicle Battery Systems: A Review" in IEEE Transactions on Vehicular Technology, vol. 68, no. 5, pp. 4286- 4305, May 2019, doi: 10.1109/TVT.2019.2904313.
7. S. Liu, J. Zhang and H. Huang, "Predictive control for electric vehicle driving with fault diagnosis and compensation" 2018 IEEE International Conference on Applied Superconductivity and Electromagnetic

- Devices (ASEMD), 2018, pp. 1-4, doi: 10.1109/ASEMD.2018.8629052.
8. Xu, Z. Wei and Y. Fan, "A prediction method of electric vehicle fault based on correlation analysis and dynamic clustering algorithm" 2019 10th International Conference on Mechanical and Aerospace Engineering (ICMAE 2019), 2019, pp. 20-23, doi: 10.1109/ICMAE48765.2019.8994663.
  9. Y. Liu, H. Ma, and G. Li, "Electric Vehicle Fault Diagnosis Based on Convolutional Neural Network" 2021 International Conference on Electrical, Electronics and Communication Engineering (ICEECE), 2021, pp. 1-5, doi: 10.1109/ICEECE52020.2021.9495839.
  10. Huang, Q. Xu, and Y. Zhang, "Fault Prediction and Diagnosis of Electric Vehicle Battery Based on Machine Learning" 2021 International Conference on Intelligent Transportation, Big Data and Smart City (ICITBS), 2021, pp. 36-40, doi: 10.1109/ICITBS51087.2021.00016.

# Achievement of Sustainable Development Goals and Fifth Industrial Revolution Among the School Teachers: A Study

**Ranjit Hanmantarao Desai**

Assistant Teacher  
Guru. D. J. Sardeshpande Adhyapak Vidhyalay  
Rajapur-Kodavali  
Ratnagiri, Maharashtra  
✉ ranjitsetnet2020@gmail.com

**Yuvraj Yashwant Pawar**

Associate Professor,  
Smt Putalaben Shah College of Education, Sangli  
Shivaji University  
Kolhapur, Maharashtra  
✉ yuvarajypawar@gmail.com

## ABSTRACT

The present study is aimed at studying the achievement levels of Primary, secondary and higher secondary school teachers on sustainable development, 4IR, 5IR and difference between 4IR and 5IR. For conducting the present study survey method is used. It is conducted on a sample 20 primary school teachers, 20 secondary school teachers, 20 Higher Secondary School teachers of Rajapur Taluka. Total 60 school teachers is used for this research. The sample of the study is selected through convenient sampling method. Achievement test is used for data collection. The obtained data are analysed by using the statistical technique like percentage, mean and bar graph. A three-point scale is used to present the finding of the research like more medium and lower.

**KEYWORDS** : *Achievement, Sustainable Development Goals, 4IR, 5IR.*

## INTRODUCTION

Sustainable Development Goals are the blueprint to achieve a better and more sustainable future for all. They address the global challenges we face, including those related to poverty, inequality, climate change, environmental degradation, peace and justice. Addressing global challenges requires embracing change for the better in the future. Man has achieved great success in all fields by using his intelligence. A good example of this is all the five industrial revolutions. The principle of 5IR considers development through the cooperation of technology and human beings. The combination of technology and humans will lead to quality work, increases capacity, problem solving, and pleasant life. The 5IR will be used to fulfil the individual's needs with quality. Through teacher training programs, discussion with teacher on Sustainable development and the 5IR has been taken. From this discussion it was realized that school teachers have little knowledge about sustainable development and the fifth industrial revolution. Therefore, relevant research has been undertaken with the aim of sensitizing school

teachers at Primary, Secondary and Higher Secondary level about sustainable development and the 5IR.

## STATEMENT OF THE PROBLEM

Achievement of sustainable development goals and fifth industrial revolution among the school teachers: A study

## OBJECTIVES OF THE STUDY

1. To study the achievement of sustainable development goals among the school teachers of Primary, Secondary and Higher Secondary level.
2. To examine the achievement of 4IR and 5IR among the school teachers of Primary, Secondary and Higher Secondary level.
3. To suggest the remedies.

## NEED AND IMPORTANCE OF THE STUDY

The Government and Educational Institutes will be aware of the current situation in the context of

Sustainable Development and 5IR . the remedial action programs will be implemented accordingly.

2. In a keeping with the changes in the fifth industrial revolution, the organization will continue to drive and the government will continue to productive in providing physical facility in schools, teacher training, digital classrooms and enthusiastic climates etc.
3. Within the collaboration of human and technology, there will be increases in sustainable development and capability in 4IR and 5IR. centered curriculum development, qualitative teaching learning process, all round evolution process, qualitative teacher etc.
4. Educational Institutes and governments will realize that they will evaluate themselves to change in behavior according to time and social educational challenges.
5. Enable teachers to be aware of the changing abilities needs of students. make school teachers aware of their own potential and challenges with time.
6. Understand the need for innovative technologies and collaborative environment of human beings.

### LIMITATIONS OF THE STUDY

1. The research is limited to Achievement of sustainable development, 4IR and 5IR.
2. The present research is for school teachers in primary, Secondary and Higher Secondary Schools.
3. The present research is for school of Marathi medium in Rajapur Taluka of Ratnagiri district.

### SAMPLE SELECTION

Present study was delimited to the Primary secondary and Higher Secondary School teachers in Rajapur Taluka. Therefore, the population of the study was compared teachers' achievement from above subject. Sample was selected by convenient sampling technique. Sample of the study consisted of 20 primary teachers, 20 secondary teachers and 20 Higher Secondary teachers who were teacher in Rajapur Taluka Ratnagiri district. it was convenient to the research.

### ASSUMPTIONS

1. Change in the industrial revolutions leads to more achievement in various fields.
2. Competencies in sustainable development, 4IR , 5IR have been Implemented into School curriculum to enhance teacher and student achievement level.

### METHODOLOGY

Survey method was adopted to conduct the investigation. variables include in the research are achievement skills of sustainable development, 4IR and 5IR among the primary Secondary and Higher Secondary teachers.

### TOOLS USED AND DATA COLLECTION ACHIEVEMENT TEST

Achievement test was used for data collection of the present research. The achievement test includes basic objective questions based on sustainable development, 4IR, 5IR for primary, secondary and higher secondary school teachers. Achievement test was created though Google Form. Achievement test was made up to 20 marks. In achievement test 5 questions on sustainable development, 7 questions on 4IR , 8 questions on 5IR . The present achievement test was checked and finalized by experienced primary, secondary add Higher Secondary teachers in Rajapur Taluka.

### DATA ANALYSIS, INTERPRETATION AND CONCLUSION

Statistical techniques such as Percentage, Mean, Bar Graph etc. have been used. A five-point scale of excellent, good, satisfactory, unsatisfactory, less was used to draw the observation and interpretation. the scale is given as Excellent: 81-100, Good :61-80 , Satisfactory: 41-60 , Unsatisfactory : 21-40 ,Less:0-20. The conclusion was presented range of three points like high, medium, low. The scale is as More -:71-100, Medium: 41 – 70, Low: 0-40.

### DATA ANALYSIS

**Table 1. Achievement of School Teachers**

Sr. No.	Teachers School Level	Result of Teachers			
		No of Pass Teachers	%	No of Fail Teachers	%
1	Primary School Teachers	7	35	13	65



2	Secondary School Teachers	5	25	15	75
3	Higher Secondary School Teachers	4	20	16	80
	Average	5	27	15	73

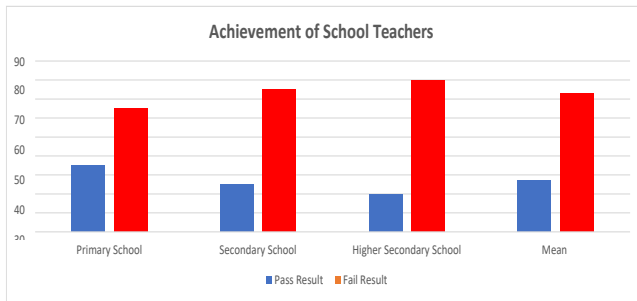

**Observation and Interpretation**

1. Achievement of Primary school teachers about sustainable development, 4IR and 5IR is 35 %. That

- means achievement of Primary school teachers about sustainable development ,4IR and 5IR is unsatisfactory .
2. Achievement of Secondary school teachers about sustainable development ,4IR and 5IR is 25%. That means achievement of Secondary school teachers about sustainable development,4IR and 5IR is unsatisfactory.
  3. Achievement of Higher Secondary school teachers about sustainable development,4IR and 5IR is 20% . That means achievement of Higher Secondary school teachers about sustainable development,4IR and 5IR is Less.
  4. Mean of Achievement for Primary, Secondary, Higher Secondary school teachers about sustainable development, 4IR and 5IR is 27 % . That means mean of Achievement for Primary, Secondary, Higher Secondary school teachers about sustainable development, 4IR and 5IR is unsatisfactory.

**Table 2: Achievement of School Teacher in SDG, 4IR and 5IR**

Sr. No.	Teachers School Level	Achievement Areas	Number Of Responses			
			Correct Responses (Out of 20 )	%	Incorrect Responses (Out of 20 )	%
1	Primary School Teachers	Achievement in SDG	6	30	14	70
		Achievement in 4IR	8	40	12	60
		Achievement in 5IR	9	45	11	55
		<b>Average</b>	8	38	12	62
2	Secondary School Teachers	Achievement in SDG	4	20	16	80
		Achievement in 4IR	9	45	11	55
		Achievement in 5IR	7	35	13	65
		<b>Average</b>	7	33	13	67
2	Higher Secondary School Teacher	Achievement in SDG	6	30	14	70
		Achievement in 4IR	7	35	13	65
		Achievement in 5IR	5	25	15	75
		<b>Average</b>	6	30	14	70

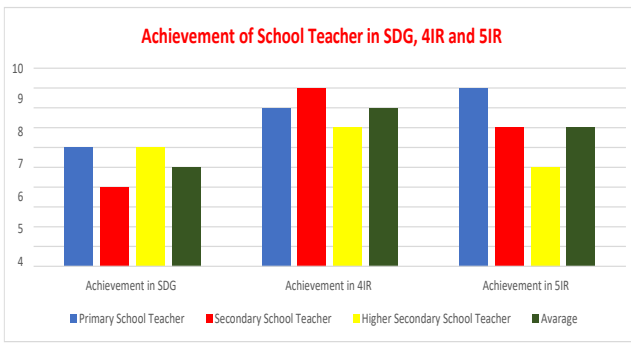

## OBSERVATION AND INTERPRETATION

1. Achievement of primary school teachers about sustainable developments is 30% , 4IR is 40 % and 5IR is 45 % . Achievement mean of primary school teachers is 38 % . That means achievement of primary school teachers about sustainable developments and 4IR is Unsatisfactory. Achievement of primary school teachers about 5IR is satisfactory. Achievement mean of primary school teachers is Unsatisfactory.
2. Achievement of secondary school teachers about sustainable developments is 20%, 4IR is 45 % and 5IR is 35 % . Achievement mean of secondary school teachers is 33 % . That means achievement of secondary school teachers about sustainable developments is Less. Achievement of secondary school teachers about 4IR is Unsatisfactory. Achievement of secondary school teachers about 5IR is satisfactory. Achievement mean of secondary school teachers is Unsatisfactory.
3. Achievement of higher secondary school teachers about sustainable developments is 30%, 4IR is 35 % and 5IR is 25 % . Achievement mean of higher secondary school teachers is 30%. That means achievement of higher secondary school teachers about sustainable developments ,4IR and 5IR is Unsatisfactory. Achievement mean of higher secondary school teachers is Unsatisfactory.
4. Achievement of primary school teachers, secondary school teachers, higher secondary school teachers about sustainable developments, 4IR and 5IR is Unsatisfactory.

## CONCLUSIONS

1. Achievement of primary school teachers about sustainable developments and 4IR is Low. Achievement of primary school teachers about 5IR is Medium.
2. Achievement of secondary school teachers about sustainable developments, 4IR is Low. Achievement of secondary school teachers about 5IR is Medium.
3. Achievement of higher secondary school teachers about sustainable developments ,4IR and 5IR is Low. 4. Achievement of Primary school teachers, Secondary school teachers, Higher secondary school teachers about sustainable developments, 4IR and 5IR is Low.

## RECOMMENDATIONS

1. Government should arrange Seminar, training programs, workshops to aware teachers about the theoretical aspects of Sustainable development and fifth industrial revolution.
2. The government should provide manuals workbooks, reference books and study material to school teacher for effectively use of sustainable development and 5IR in the educational process. .
3. The government should provide innovative technology and physical facilities in the school to meet the modern change for the quality growth and development of the school.
4. School administrator and principal of School should organize guest lectures, seminar, workshops and conference by various experts or sensitives teachers about sustainable development and change of the industrial revolution.
5. School teachers should use a variety of reference sources basic information on sustainable development and current changes of the 5IR
6. Teacher should empower themselves to meet the challenges of sustainable development and change of the fifth industrial revolution.

7. Acquiring content knowledge and Current Knowledge is essential for school teachers and principal to be able to meet the effectful change and challenges.
8. There is a need to create awareness at the school level about sustainable development , 4IR and 5IR.

## REFERENCES

1. Achyut Godbole (2022 Jun 14 ): 4IR Future Technology and its Implementation. [Video].YouTube. <https://youtu.be/kXRpYTimhLA?si=Ib9zM4nR3L-roLGe>.
2. Ajishnu Roy, Kousik Pramanick(2019):Analyzing progress of sustainable development goal 6 in India :Past,present,andfuture. Volume232, ,Pages1049-1065: <https://doi.org/10.1016/j>.
3. Aadesh Singh (2023 Sep. 22):Industrial Revolution | World History | Lecture - 5 | UPSC | GS History. [Video].YouTube. [https://youtu.be/\\_NO7kA4-LZc?si=tIjp79sx-G\\_-6dHF](https://youtu.be/_NO7kA4-LZc?si=tIjp79sx-G_-6dHF).
4. Babarsie Classes (2024 Jan.19):Industrial Economics Class 12: Environment & Sustainable Development – Chapter 9. [Video].YouTube. [https://youtu.be/1kT9S3cE7k0?si=jzbrygkr\\_UjtlCDA](https://youtu.be/1kT9S3cE7k0?si=jzbrygkr_UjtlCDA).
5. Dr.kiran Desale(2020 Sep. 23):Economics(7) Sustainable Development MPSC Sustainable Development [Video].YouTube. <https://youtu.be/puFGuvWgMW4?si=0wy-VHgcHpnIJJQi>.
6. Kothari. C. R, (2009):Research Methodology, New Age International Publishers.
7. M. Prabhakar Christopher David (March 2018): Sustainable Development Goals (SDGs)-Challenges for India, Department of Business Administration, School of Management studies, Vels University, Polavaram, Chennai. Vol 9,No.3 DOI Number: 10.5958/0976-5506.2018.00172.9.
8. Rajat Arora (2023 March.14): Environment and Sustainable development[Video].YouTube. [https://youtu.be/fv5INudepMQ?si=18wpCGW\\_g7bS8Dlq](https://youtu.be/fv5INudepMQ?si=18wpCGW_g7bS8Dlq).

# Creative Metrics for Evaluating the Avoidance of Ill-beings & Promotion of Well-beings

**Amey V. Diwan**

Assistant Professor  
Civil Engineering  
Dr. D.Y.Patil Pratishthan's College of Engineering  
Salokhenagar, Kolhapur, Maharashtra  
✉ ameyvdiwan@gmail.com

**Vinayak V. Diwan**

Formerly Head  
Dept. of Civil Engineering  
New Polytechnic, Unchagaon  
Kolhapur, Maharashtra  
✉ diwanvv@gmail.com

## ABSTRACT

In the era of globalization, privatization & liberalization in most of the countries all over the world, are changing drastically towards highest growth of automation. As a result, the fastest developments in the field of Electronics, Computers, Information Technology, .Internet, Automation, Robotics, Artificial Intelligence [AI], Machine Learning [ML], Data Science [DS] etc. there are revolutions in industries from Industry 3.0, Industry 3.5, Industry 4.0 & now entering in to Industry 5.0 with the help of AI.

There are many doubts & challenges in the implementation of AI in reality. This papers mainly deals with five challenges in AI like

- 1] Facing technology-related problems in the development process of AI
- 2] Inaccurate assumptions done about AI capabilities
- 3] Ethical challenges in the adoption of AI
- 4] Failures in reproducing laboratory results in prototype [in the real world]
- 5] Scaling AI system.

They are discussed in details with few examples along with solutions over each of them to avoid ill-beings & to have sustainable development for well-beings.

## INTRODUCTION

**P**roblems about the artificial intelligence [AI] are from a misunderstanding of what is exactly AI? What are the capabilities of AI? Whether implementation of AI makes sense in particular situations? How many companies lack an infrastructure for integrating the technology into their processes and quality data for AI model training. Industries & business house, institutes are willing to explore generative AI services with the help of .ChatGPT and other foundation AI models.

## HISTORICAL BACKGROUND

Industry 1.0 – Started around 1780, 1st revolution

focused on industrial production based on machines, operated by steam and water instead of human or animal power.

Industry 2.0 – Started around 1870, 2nd industrial revolution was based on electrification and took place with mass production through assembly lines.

Industry 3.0 – Started around 1970, 3rd industrial revolution saw automation through the use of computers and electronics. This was enhanced by globalisation (Industry 3.5), involving offshoring of production to low-cost economies.

Industry 4.0 - Currently living in 4th industrial revolution,

which is based around the concept of digitalisation and includes automation, artificial intelligence (AI) technologies, connected devices, data analytics, cyber-physical systems, digital transformation, and more.

Industry 5.0 – Now entering in 5th industrial revolution with a focus on man and machines working together in collaboration. . Based upon personalisation and the use of collaborative robots, workers are free to deliver value-added tasks for customers. This latest iteration goes beyond manufacturing processes to include increased resilience, a human-centric approach, and a focus on sustainability. e.g. Use of AI-powered chatbots, face swap apps, and robot dogs only became a viable reality a couple of years ago. Neither businesses nor their technology partners have a tried and true formula for developing and deploying AI systems company wide.

## OBJECTIVES OF THE STUDY

- 1] Finding out major challenges in implementation of Artificial Intelligence [AI].
- 2] Searching for solutions of challenges in AI.
- 3] Checking transdisciplinary approach in implementation of AI.

## DATA COLLECTION AND ANALYSIS

Following are the challenges in AI related to five critical issues:

- 1] Facing technology-related problems in the development process of AI
- 2] Inaccurate assumptions done about AI capabilities
- 3] Ethical challenges in the adoption of AI
- 4] Failures in reproducing laboratory results in prototype [in the real world]
- 5] Scaling AI system.

Let us now consider these challenges one by one along with the likely solutions on them during implementation of AI in industrial Revolution – 5.0

- 1] Facing technology-related problems in the development process of AI

### Poor architecture choices

Programming for AI must have not only accurate

predictions, but also have things you should expect from an AI solution. In multi-tenant AI as a service (AIaaS) applications are serving thousands of users at a time, performance, scalability, and effortless management are equally important.

When the system reaches its maximum capacity, you will be left with an app that is too big and complex to manage effectively.

### Lack of AI explainability

Explainable artificial intelligence (XAI) is a concept about providing enough data to our client / user to clarify how AI systems come to decision making.

### Inaccurate or insufficient training data

AI systems' performance depends mainly on the quality of the data received. Companies struggle very hard to provide a substantial volume of quality data to train AI algorithms. In the field of criminal investigations, the defendant are misguiding the data investigators, similarly in the field of healthcare, data of patient like X-ray images and CT scans is difficult to obtain due to privacy reasons. It was observed that @ 85% of artificial intelligence projects delivering inaccurate or vague results due to lack of quality of input data.

### Solutions

To avoid technology-related artificial intelligence challenges, we must insist on starting artificial intelligence project with a discovery phase and create an AI proof of concept.

To map the solution requirements against your business needs, eliminate technology barriers, and plan the system architecture with the anticipated number of users in mind.

Select a technology partner who has hands on experience & knows how to overcome the data-related challenges of artificial intelligence.

For accuracy v/s explainability trade-off, the vendor of your choice should have hands-on experience.

### Inaccurate assumptions done about AI capabilities

Certain companies earn fantastic benefits of AI while others do not. The cyber-physical system performed poorly in its early days. But by learning from human



experts who had years of experience, the results improved dramatically.

Many companies are influenced by the media hype around AI and begin ambitious projects without adequate assessment of their needs, AI development costs, legal and ethical implications of the technology etc.

### **Solution**

If complete automation and reduction in employees lie at the heart of your AI strategy, you are likely to fail. Algorithms need human knowledge to eventually make accurate predictions. Smart machines would not replace the human workforce totally in future.

### **Ethical challenges in the adoption of AI**

#### *Bias in algorithmic decision making*

Data prepared by human engineers and bears the mark of social and historical inequities. e.g. US law enforcement agencies used a facial recognition system, is more likely to identify a non-white people as if criminal.

#### *Moral implications*

Few companies prefer to replace human workers with highly productive, always-on robots. Even though two-thirds of business executives believe AI will eventually create more jobs than it is going to kill,

#### *Limited transparency and explainability*

An advanced black-box used in AI, do deep learning networks fail to explain the reasoning behind their decisions. It also helps in case of system errors and inflicted harm. I still remember the “Automatic meal feeding machine shown in the movie Modern Times by Charlee Chaplain in middle of 20th the century.” Horrible news leaked recently after about 1½ year from a leading company manufacturing AI based Robot. The robot had an attempt to kill an engineer on shop floor, who was in hospital for couple of months, and saved by switching off the said robot by workers.

### **Solution**

Solve most ethical artificial intelligence problems by creating balanced training datasets that include images of people representing different ethnic, gender, and age groups. e.g. AI-powered HR management software can

scan more resumes than human specialists and identify potential candidates based on education and working experience.

Develop a set of ethical guidelines and principles to reflect commitment to fairness, transparency, privacy, and accountability.

Regular ethical audits of AI systems to identify and address potential ethical issues.

Training programs for employees involved in AI development and deployment to raise awareness of ethical issues and best practices.

### **Failures in reproducing laboratory results in prototype [in the real world]**

The problem with AI is, most of the industries fail to reproduce their laboratory results in to the actual production or service to heir clients effectively. Many wel-known blue chip companies are not willing to share complete research findings and source code as their trade secrets with fellow scientists and AI developers.

### **Solution**

In industries, many points may help to achieve the prototype results matching with laboratory trials using AI are like variations, understand the constraints, and unpredictability of the real world that can affect the performance of the AI system

Use data augmentation techniques like adding noise, introducing variations,

Pre-training AI model on a vast, comprehensive dataset, and subsequently refine it by fine-tuning with domain-specific data

Configure AI systems to update and retrain themselves with new real-world data.

Establish feedback loops with real-world users or operators

Monitoring and debugging tools to identify and address issues that arise in real-world

In case of lacks the skills and expertise to reset/upgrade, take help of experts in AI.

### **Scaling AI systems**

Software scalability issues haunt various IT projects

regardless of their technology including AI. About 53% of AI projects successfully transition from prototypes to production. This statistic indicates a lack of technical expertise, competencies, and resources needed to deploy intelligent systems at a large scale.

Other factors behind AI scalability challenges include:

Size of data sets for algorithm training and the quality of their data

Utilization of significant computing resources for AI model training and deployment

Increasing complexity of present-day AI models

Need to expand the underlying cloud infrastructure to accommodate for the AI model evolution and implementation across multiple use cases

Need to integrate AI models with other systems within IT infrastructure

### Solution

Continuous knowledge transfer might be a viable solution to the AI scalability problems.

Many companies rely on third-party vendors to build smart systems with AI. They must ensure their pilot projects help transfer knowledge from vendors to the operating staff. Assess AI infrastructure to identify any potential bottlenecks and establish clear.

### CONCLUSIONS

There are five major challenges in the implementation of Artificial Intelligence [AI] almost in all the field for quality, reliability, transparency, accountability, economy and sustainable development.

To overcome challenges in AI systems effectively in reality, we need

- a. Start from a discovery phase and create an AI proof of concept.

- b. Use of hands on experience & knows to tackle data-related challenges of AI.
- c. For accuracy v/s explainability trade-off, the vendor must have hands-on experience.
- d. Smart machines would not replace the human workforce totally in future.
- e. Creat balanced training datasets
- f. Set ethical guidelines and principles for transparency, privacy, and accountability.
- g. Regular ethical audits of AI systems
- h. Training programs for employees involved in AI development
- i. Use AI with variations, understand the constraints, and unpredictability.
- j. Use data augmentation techniques like adding noise, introducing variations,
- k. Pre-training AI model on a vast, comprehensive dataset, and subsequently refine it.

Transdisciplinary approach in the industry will be most useful for effective implementation of Ai like Allrounder player in Cricket.

### LIMITATIONS

- 1] The authors are engineers but not from the branches like Computer, IT, ETC, AI, ML, or Data science etc.
- 2] Being civil engineers, not related directly with machinery for productions or related.
- 3] The branch Artificial intelligence is still under developing stage in India.
- 4] Access of Internet and it's speed is still fluctuating at many places.

# Collaborative Strategies for 5th Industrial Revolution

**Minal Vijay Patil**

Lecturer

Shri.Chh.Shahu Junior College of Education

Rukadi

✉ mdesai15092015@gmail.com

**P. B. Darade**

Associate Professor

Acharya Javadekar college of Education

Gargoti

✉ prabhadarade7571@gmail.com

## ABSTRACT

We all want to give our future generation the best luxurious, privilege and quality life. But it is only possible when we prepare people for 5th industrial revolution which is a combination of technological development and sustainable development. Industry 5.0 refers to the collaboration of advanced technologies such as robotics, and intelligent solutions with humans to improve efficiency and performance. Collaboration has become a 21st century skill and trend. This research paper explores 7 collaborative strategies which will be useful in 5th industrial revolution. Also by using these strategies educational institutes can develop sustainable goals for future needs. Hence Educators, administrators, parents and employers must be aware and conscious about their role about sustainable development goals which are necessary for 5th industrial revolution.

**KEYWORDS** : Collaborative strategies, 5th Industrial Revolution, Remote collaboration, Cross functional Collaboration, Open innovation, Co-creation, Virtual collaboration, Agile collaboration, Community collaboration.

## INTRODUCTION

We all want to give our future generation the best luxurious, privilege and quality life. But it is only possible when we prepare people for 5th industrial revolution which is a combination of technological development and sustainable development. Industry 5.0 refers to the collaboration of advanced technologies such as robotics, and intelligent solutions with humans to improve efficiency and performance (Al-Emran Mustafa, Al-Sharafi Mohammed, Dec 2022). Also the 5th industrial revolution incorporates concepts such as sustainability, human centeredness and concern for the environment. There are 17 goals of sustainable development. The 5th industrial revolution will give us opportunities new business of recycling product and making profit with progress. Nowadays we are standing in front of 4th industrial revolution that is featured by a great range of new ideas and advanced technology that influences all the domains of economics and industries. This revolution affects the environmental problems like plastic waste, e-waste, garbage. We affect all our natural resources like tree, land, water etc.

Solid waste management is a multifaceted problem comprising environmental aspect. Due to exponential urban growth, it has become one of the most significant issues. (Justice Kofi Debrah, Diogo Guedes Vidal, Maria Alzira Pimenta Dinis -2021). Making people aware transformative sustainability learning is implemented in waste education center within the largest waste treatment facility in Israel. So it is necessary to aware people about sustainable development. And for that we have to use new learning approaches and strategies. From these all new strategies collaborative approach is one of them. Collaboration has become a 21st century skill and trend. Collaboration learning is an educational approach to teaching and learning that involves groups of learners working together to solve a problem, complete a task, or create a product. (Laal Marjan, Laal Mozghan).

## STATEMENT OF PROBLEM

Collaborative Strategies For 5th Industrial Revolution.  
Objectives of Research:

1. To find out collaborative Strategies For 5th industrial revolution.

## 2. Future Implementation of Collaborative Strategies in Educational Institutions.

### RESEARCH METHODOLOGY

The researcher has made the use of secondary data like reference books, booklets, journals, websites to collect the relevant data and information for study.

Collaborative Strategies for 5th Industrial Revolution

There are new collaborative Strategies that will emerge in 5th industrial revolution. These are as follows-

### REMOTE COLLABORATION

Remote Collaboration is the process by which geographical distance is removed as a deterrent to teamwork; it facilitates communication and productivity among a dispersed team of employers, wherever they are, to achieve a common goal. Remote collaboration includes video conferencing, project management, Software and collaborative platforms enable real time communication and document Sharing.

### Cross Functional Collaboration

Cross Functional collaboration is the process where individuals from different departments in an organization with different areas of expertise come together to achieve a common goal. Cross functional collaboration brings together individuals to work on common goals ,leading to innovation and improved problem solving.

### Open Innovations

Open Innovations means organizations use resources' and knowledge for innovation from multiple external sources (such as customer feedback, competitors, external agencies, public ect.)This approach allows organizations to tap into a broader pool of knowledge and expertise, accelerating innovations and reducing time to market.

### Co-creation

Co-creation is the practice of collaborating with other stakeholders to guide the design process. Participants with different roles align and offer diverse insights, usually in facilitated workshops. Designers can therefore get more holistic views of what a product or service should include.

### Agile Collaboration

Agile Collaboration is an approach to work that aims to maximize flexibility and visibility while eliminating as many barriers to getting things done as possible .It does this through a combination of processes, people and technology.

Agile methodologies, commonly used in software development, emphasize interactive and collaborative approaches, cross –functional team work closely together, frequently communicate and adapt their plans based on feedback and changing requirements.

### Virtual collaboration

Virtual collaboration is defined as a technologically –mediated method of communication, in which the sharing of information between team members is done entirely online. This type of collaboration mostly used to facilitate engagement in remote and hybrid workplaces. These technologies create immersive virtual environments where team members can interact, visualize data and work on project together, regardless of their physical locations.

### Community collaboration

Community based collaboration is the process by which citizens, agencies ,organizations and businesses make formal. Sustained commitments to work together to accomplish a shared vision. Organizations are building communities of customers, partners and stakeholders to foster collaboration and co innovations. These communities provide a platform for sharing knowledge, exchanging ideas and collaboratively solving challenges.

All these collaborative strategies depends on industries, organizations size, specificgoals, industries should assess their unique needs and rearrange this strategies that align best with their objectives.

Future Implementation of Collaborative Strategies in Educational Institutions.

Integrating environmental Science is easy to integrate SDGS.

Take seminars ,Workshops online through video conferencing, project management,

Use software and collaborative platforms enable real time communication and document Sharing.

Give students project which are collaborate with different departments and different field like climate change observations, Global Warming etc.

Take interschool and college competitions for innovations and creativity Make hybrid workplaces

Universities have adopting bicycles and electrical vehicles into campus lifestyle Paperless Digital Work.

Ancient Sustainable health practices like Ayurveda, Yoga and Naturopathy have gained attention and are slowly getting integrated into campus life.

Eco School programs in Indian Ocean Commission ISANDS like gardening, composting etc Craft exercise from waste to best classroom tea- fin and food composting

Energy consumption like solar panels, wind mills etc.

Collaboration for zero Hunger by using donation of food, cloths, money Health remedied programs laughter club, friend group for loneliness ect. Industrial collaboration for skill based labor for sustainable reproduction.

Partnership with Industries for Sustainable development by using Corporate Social Responsibility.

Participation of local clean up program.

Staff training professional development in sustainability education.

Lead a green club-Student who are more interested in S.D and tae activities.

## CONCLUSION

The sustainable development is a major subject in today world. So we have to create ability to face future challenges. It is necessary to develop teaching learning process. This research paper explores 7 collaborative

strategies which will useful in 5th industrial revolution. Also by using these strategies educational institutes can develop sustainable goals for future needs. Hence Educators, administrators, parents and employers must be aware and conscious about their role about sustainable development goals which are necessary for 5th industrial revolution.

## REFERENCES

1. Al Emran Mostafa ,Al –Sharafi Mohammed (Dec 2022), :Revolutionizing Education Challenges and Future Research Agendas ,International Journal of Information Technology and Language studies, Vol,6, Issue 3,(2022), pp,I-5, <https://journals.sfu.ca/ijitls>.
2. Justice Kofi Debrah, Diogo Guedes Vidal, Maria Alzira Pimenta Dinis(2021), Raising Awareness on Solid Waste Management through Formal Education for Sustainability :A Developing Countries Evidence review , Recycling 2021 ,6,6.<https://doi.org/10.3390/Recycling6010006>.
3. Kinga Polynczuk-Alenius (2015), Creativity For Sustainable development? ,Journal of Cultural Science, University of Helsinki ,Finland Vol.8,No.1
4. Laal Marjan, Laal Mozghan (2012),Collaborative Learning :What is it ?,Procedia –Social and Behavioral Sciences 31 (2012)491-495.
5. Report on Sustainable Development Goal 17,Partnership for Goals ,Shiv Nadar, Institutte of Eminence Deemed University, New Dehli.
6. <https://article.murata.com/en-sg/article/what-is-fifth-industrial-revolution>.
7. <https://www.britannica.com/science/recycling>
8. <https://www.cognizant.com/us/en/glossary/remote-collaboration>
9. <https://www.iisd.org/mission-and-goals/sustainable-development>.
10. <https://www.interaction-design.org/literature/topics/co-creation>



# Performance Analysis of Regenerative Braking of BLDC Motor using PID Controller

Awadhut B. Chougale

✉ awadhutchougale@gmail.com

Aniket A. Prabhavalikar

✉ prabhavalikaraniket@gmail.com

Assistant Professor  
Electrical Engineering Department  
Dr. D. Y. Patil Prathistan's College of Engineering  
Salokhenagar, Kolhapur, Maharashtra

## ABSTRACT

Regenerative braking gives a viable method for expanding the driving scope of battery powered electric vehicles. This proposed methodology presents the equivalent power circuit and activity standards of an EV utilizing regenerative braking control innovation. Amid the braking time frame, the exchanging succession of the power converter is controlled to backwards the yield torque of the three-stage brushless direct-current motor, with the goal that the braking vitality can be come back to the battery. Contrasted and the introduced techniques, this innovation can accomplish a few objectives: vitality recuperation, electric braking, ultra-calm braking and expanding the driving reach. Benefits and disadvantages of various braking control methodology are additionally explained. State-space model of the EVs under vitality regenerative braking activity is built up, taking into account that parameter varieties are unavoidable because of temperature change, estimated blunder, un-demonstrated elements, outside unsettling influence and time-differing framework parameters, a sliding mode robust controller is structured and executed. Stage current and DC-interface voltage are chosen as the state factors, individually. The comparing control law is additionally given. The proposed control conspire is contrasted and a customary proportional- integral (PI) controller. A research facility EV for analysis is setup to check the proposed plan. Test results demonstrate that the drive scope of EVs can be enhanced about 17% utilizing the proposed controller with energy regeneration control.

**KEYWORDS** : *Regenerative breaking, Electrical Vehicles, Sliding mode robust controller, Proportional integral controller.*

## INTRODUCTION

With the development of vitality emergency, methods for lessening air-contamination have turned into the incredible test. These days, fossil-powered vehicles have turned into the real transportation instruments. Automakers have tried to discover green, vitality sparing and zero contamination transportation devices. Hence, electric vehicles have developed at a quickened pace of late [1–3]. Notwithstanding, a portion of the fundamental challenges for commercialization of EVs, for example, driving extent still remain. Long time for charging battery pack and short separation of driving reach are the real issues for EVs. Successful

battery usage and propelled engine control have turned into an imperative issue for EVs [4– 6].

A pure electric vehicle contains three noteworthy parts: the power battery pack, the driving engine, brushless direct- current motor and switched reluctance motor (SRM) [7] and the power converter controller. Among all the driving engines, the brushless direct-current (DC) motor has numerous favorable circumstances over other brush DC motors, IMs and switch reluctant motors. It has the benefits of straightforward structure, high proficiency, electronic commutating gadget, high beginning torque, quiet activity and fast range, and so on. Consequently, the brushless DC motor has been

generally utilized in EVs [8, 9]. Regular EVs utilize mechanical brakes to build the rubbing of the wheel for deceleration purposes. Therefore, the braking active vitality is squandered. In view of this issue, this paper will talk about how to change over the dynamic vitality into electrical vitality that can be energized to the battery pack. Thus, regenerative braking can understand both electric braking and vitality reserve funds.

## LITERATURE SURVEY

Up until now, numerous articles have shown the regenerative braking strategy of EVs [2, 3, 10, 11]. Khastgir [12] displayed a novel technique for actualizing a regenerative brake methodology without changing the current mechanical stopping mechanism of an ease traditional vehicle which is changed over to a minimal effort crossover electric vehicle (HEV) for front pivot applications, i.e., without including complex electronic frameworks like enemy of bolted slowing mechanism (ABS). The outcomes demonstrate a capability of 30% of brake vitality recuperation with the proposed procedure. Sankavaram [13] proposed efficient information driven process for recognizing and diagnosing deficiencies in the regenerative slowing mechanism of HEVs. Their outcomes show that exceptionally exact blame determination is conceivable with the example acknowledgment based strategies. A hearty H<sub>2</sub>/H controller is advanced for a battery EV [14, 15], the trial results show that the driving reach can be enhanced 4% when utilizing H<sub>∞</sub> controller rather than customary relative necessary (PI) controller, which exhibit that H<sub>∞</sub> controller can recuperation more vitality than PI controller under similar tasks. Be that as it may, the execution of H<sub>∞</sub> controller needs complex mathematic calculations. Thinking about the unverifiable parameters while demonstrating the framework, a hearty state input H<sub>∞</sub> controller is likewise given [13].

Regenerative braking is acknowledged by utilizing the extra vitality putting away parts (ultra-capacitor pack) to ingest the immediate braking vitality. In this way, the battery pack and ultra-capacitor shape a half and half power supply framework (HPSS), and the depictions of HPSS can be found in [8– 12]; (2) so as to enhance the DC-interface voltage of the power converter, a bidirectional DC-DC control converter is utilized

for boosting control [12,13]; (3) braking vitality is recouped by utilizing the driving force converter itself for charging control, the vitality recovery control is accomplished by utilizing distinctive control technique, this can be found in [12,13]. For Category (1), the extra vitality putting away parts should be charged and released by means of a DC-DC control converter, status of the ultra-capacitor, (for example, full charged or under-voltage) should be procured, along these lines, voltage and current sensors must be introduced in the controller, thusly, the braking vitality is briefly put away in the ultra-capacitor pack, this plan makes the entire framework increasingly confused, also, because of the high cost of ultra-capacitor pack, the expense of the controller would be more costly than a traditional controller. For Category (2), since the back electromotive power is much lower than the battery's terminal voltage, even at fast, subsequently, the BEMF likewise should be supported for charging the battery pack. A portion of the controllers accomplish this objective by including an extra buck-help controller. The most ideal way, as we would like to think, to understand this objective, is by utilizing the controller itself.

## METHODOLOGY

To abridge the previously mentioned strategies, this paper will focus on the methods for acknowledging regenerative braking innovation by utilizing a strong sliding mode controller. Contrasted and regular control techniques, parameter varieties and aggravation are considered in the structure of the proposed powerful controller. Correlations on the driving scope of EVs utilizing diverse controllers have been executed. The yield of the controller decides the exchanging condition of the power transistors in the converter. The below figure 1 shows the block diagram of proposed methodology.

Square outline of the BLDC motor with regenerative braking consolidate with AT89c52 microcontroller, BLDC motor, 48v battery, Hall sensor, switch for regenerative braking appears in fig 1.

### System overview

BLDC motors are pretty much like the synchronous motors. This demonstrates the attractive field created by the stator and the attractive field delivered by the

rotor pivot at a similar recurrence. Fig.2 demonstrates the constructional perspective of BLDC.

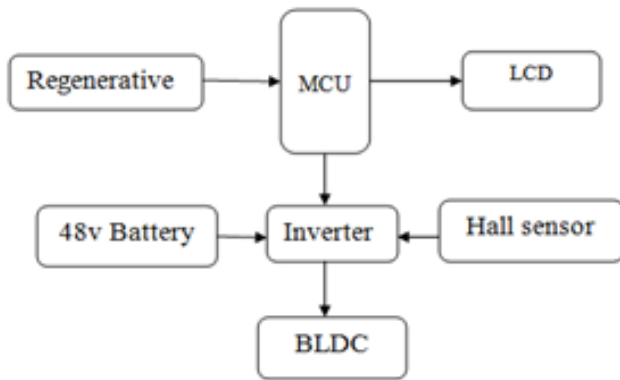

Fig. 1 Block Diagram of Proposed Methodology

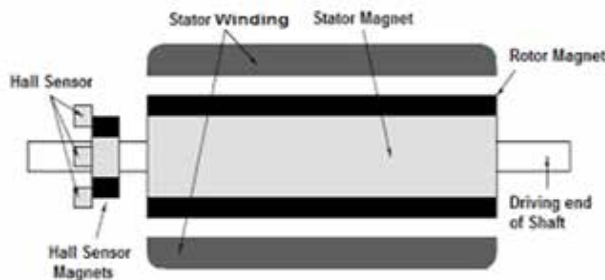

Fig.2 Stator, Rotor, and Hall sensors of PMBLDC motor

**Stator**  
 The stator of a BLDC motor is made of stacked steel overlays with windings orchestrated in the openings that are cut along the inward fringe. Most BLDC motors have three stator windings connected in the star. Every one of these windings is collected alongside different curls interconnected to drive a winding. The curls are kept in the openings and they are interconnected to frame a winding. Every one of these windings is disseminated over the stator fringe region to frame even quantities of posts.

**Rotor**  
 The rotor is shaped from the lasting magnet and can modify from two to eight post sets with exchange North and South poles. A reasonable attractive material is picked to shape the engine relying on the required field thickness in the rotor. At present, uncommon earth combination Magnets are utilized to make permanent magnets.

**Hall Sensors**

To turn the BLDC motor, the stator windings should be invigorated in an arrangement. It is basic to realize the rotor position so as to realize which winding will be invigorated. Corridor sensors implanted into the stator on the non-driving end of the motor see the Rotor position. At the point when the rotor shafts go close to the Hall Effect sensors, they give a high or low flag dependent on which the correct request of replacement can be known. For appropriate replacement, the current must change its extremity each time a magnet shaft goes by the sensor. In the brushed DC motor, the commutator and brushes play out the extremity inversion. In the BLDC motor, the extremity inversion is performed by power MOSFETS, which must be exchanged in synchronism with the rotor position. Table 1 depicts the changing arrangement to get stage flows. To turn the BLDC motor, the stator windings ought to be energized in a grouping. Every recompense grouping empowers one twisting to positive power and the second winding is invigorated to negative and third winding non-stimulated. It is essential to realize the rotor position for choosing empowering grouping.

Table 1. Swich Table of the Power Converter in Which Two Power Mosfet’s Conducted at the Same Time in Each Sectro

Switching Interval in Degree	Position Sensor			Switch Closed		Phase Current		
	H1	H2	H3			A	B	C
0-60	1	0	0	S1	S1	+	-	OFF
60-120	1	1	0	S1	S6	+	OFF	-
120-180	0	1	0	S3	S6	OFF	-	-
180-240	0	1	1	S3	S2	-	-	OFF
240-300	0	0	1	S5	S2	-	OFF	-
300-360	1	0	1	S5	S4	OFF	-	-

**Theory of operation**

For Each compensation grouping, one winding is invigorated to positive, the other winding is empowered negative and the following is in a non-stimulated condition.[5] Torque is delivered because of the

collaboration between the two attractive fields produced by the stator curls and the perpetual magnets. In a perfect world, the pinnacle torque is seen when these two fields are in quadrature to one another. So as to keep the motor running, the attractive field created by the windings should move their situation, as the rotor moves to make up for lost time with the moving stator field.

### Commutation Sequence

For each 60° of pivot, one of the Hall Effect sensors changes the state in this manner the recompense grouping. It finds a way to complete a cycle. Be that as it may, one electrical cycle may not finish a mechanical insurgency of the rotor. The quantities of electrical cycles rehashed demonstrate total one mechanical pivot signified by the rotor post sets. A three-stage connect inverter is utilized to work the BLDC motor. There are six switches and these switches are turned ON or OFF contingent on Hall sensor inputs. The Pulse Width Modulated (PWM) methods are utilized to turn ON or OFF the switches. So as to change the speed, these signs ought to be PWM at an a lot higher recurrence than the motor recurrence.

### Mathematical Modeling of BLDC Motor

In demonstrating a BLDC motor a, b, c, stage variable model is favored as the common inductance among stator and rotor is non-sinusoidal. Before planning the conditions following suppositions are made in demonstrating the BLDC motor.

- The motor is not saturated.
- Resistances of all the stator windings are equal, self and mutual inductances are constant.
- The power semiconductor devices are ideal.

There are two conceivable techniques to show a BLDC motor, one is a, b, c stage variable model and the other is d-q pivot demonstrate. BLDC motor has the changeless magnet with trapezoidal back EMF while synchronous motor has sinusoidal back EMF. [4]-[5]-[6] So changing to d-q hub does not give any additional advantage, in this manner a, b, c stage variable model is picked. The comparable outline of the BLDC motor is as appeared in the fig 3.

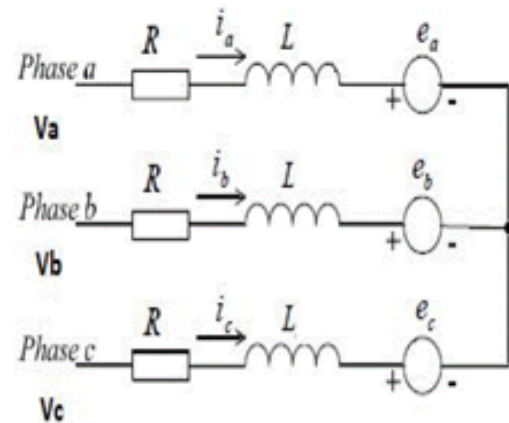

Fig. 3 Equivalent circuit of BLDC motor

The voltage equations of BLDC motor are:

$$V_a = R_a i_a + \frac{d}{dt} L_a i_a + E_a \quad (1)$$

$$V_b = R_b i_b + \frac{d}{dt} L_b i_b + E_b \quad (2)$$

$$V_c = R_c i_c + \frac{d}{dt} L_c i_c + E_c \quad (3)$$

Where,  $L_a=L_b=L_c=L$ , is the self inductance.  $V_a, V_b, V_c$ , is the per phase stator voltages.  $R$  is the per phase stator resistance.  $i_a, i_b, i_c$ , are the per phase stator currents.  $E_a, E_b, E_c$ , are the induced back-emf.

The created back emf is trapezoidal fit as a fiddle because of perpetual magnet straddling on the rotor and its expression is given below.

$$E_a = K_e * \frac{d}{dt} (\theta) * \omega_r (t) \quad (4)$$

$$E_b = K_e * \frac{d}{dt} (\theta - 2\pi/3) * \omega_r (t) \quad (5)$$

$$E_c = K_e * \frac{d}{dt} (\theta + 2\pi/3) * \omega_r (t) \quad (6)$$

Where,  $K_e$  is the back emf constant and  $\omega_r$  is the mechanical speed of the rotor. The electromagnetic torque equation is given by.

$$T_e = 1/\omega_r (e_a i_a + e_b i_b + e_c i_c) \quad (7)$$

Where,  $T_e$  is the electromagnetic torque. Equation for motion is given by.

$$J \frac{d}{dt} (\omega_m) + B \omega_m = T_e + T_l \quad (8)$$

Where, B is damping constant, J is moment of inertia of the drive, Tl is load torque.

## REGENERATIVE BREAKING

In electric vehicles, for the braking to be done superbly and easily, electric braking ought to be in conjugation with mechanical braking utilized. These is finished by applying electrical braking to back off the electric vehicles to a lower speed and after those mechanical brakes are connected to convey the vehicle to the stop. [7]-[8] Electrical braking diminishes the wear of the brake shoes and gives a higher rate of braking hindrance, subsequently conveys the vehicle rapidly to rest and abbreviates the running time to a significant degree.

There are two potential outcomes if the info current is in stage with back emf, motoring torque is produced generally in the event that the information current is in out of stage with back emf, braking torque is created. [9] The electromagnetic torque created in stage 'an' is: To charge the battery amid regenerative braking there are two conditions that must be fulfilled. First is that the voltage delivered or the back EMF must be more noteworthy than the provided voltage. Second is the current must alter its course and spill out of motor to the battery.

To accomplish the above condition the motor must keep running at the speed more noteworthy than the evaluated speed. On account of BLDC motors as the main condition is beyond the realm of imagination so the motor must keep running at speed more prominent than appraised speed to charge the batteries. This can be accomplished just if the vehicle is running down a declining inclination. In this way, to control or lessen the speed of the vehicle on downhill we should utilize the regenerative slowing mechanism.

The equation for the proportional feedback is given by

$$u = K_e * e \quad (10)$$

Where, e is the error and Ke is proportional gain. The definition of the integral feedback is given by.

$$u = K_i \int e \, dt \quad (11)$$

Where, Ki is integration gain factor. The definition of the derivative feedback is given by.

$$u = K_d \, d/dt (e) \quad (12)$$

Where, Kd is derivative gain factor. In the PID controller, we have a combination of P, I and D control, that is

$$u = K_e * e + K_i \int e \, dt + K_d \, d/dt (e) \quad (13)$$

## RESULT ANALYSIS

### Simulink model

Figure shows the main model of the three phases BLDC motor which is designed in MATLAB/Simulink environment in accordance with a mathematical model derived previously.

This Model consists of four sub-blocks named as battery supply system, BLDC motor block, H-bridge Inverter block, PID controller and PWM switching for gate signal. The feedback of actual speed is given to the PID controller along with reference speed. The PID controller adjusts the duty cycle of the power electronics devices MOSFET. The various logic operators and pulse width modulated signals provide the switching logic signals that are fed to the MOSFET'S gate input.

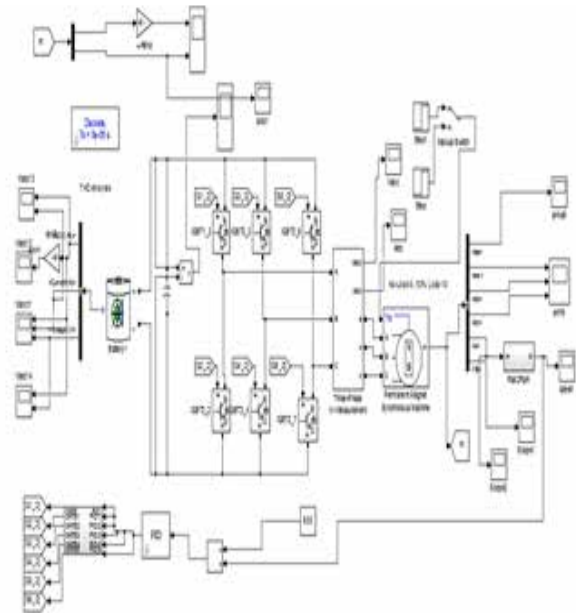

Fig.5 Simulink model of BLDC Motor

Figure 6 shows the input signals obtained from hall sensors and modulated to obtain gate signals for switching purpose.



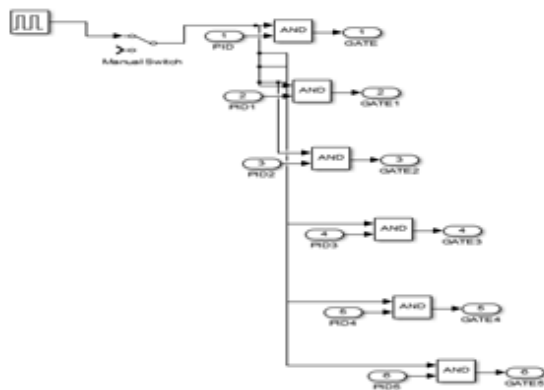

Fig. 6. Switching Logic of Simulink Model

**Simulation Results**

This section depicts simulation results for four starting, running and braking of a BLDC drive. Some of the graphs for speed, torque, current and back emf (Fig.7-13) waveforms have been shown in the following section. From the figure, it is clear that the actual motor speed catches up with the reference speed.

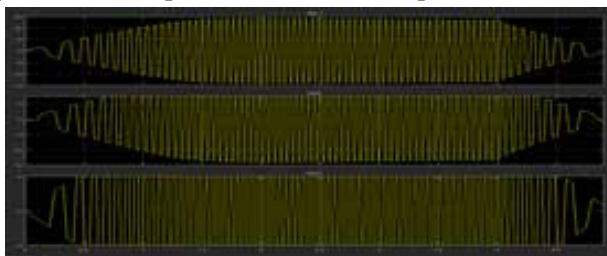

Fig. 7. Back EMF

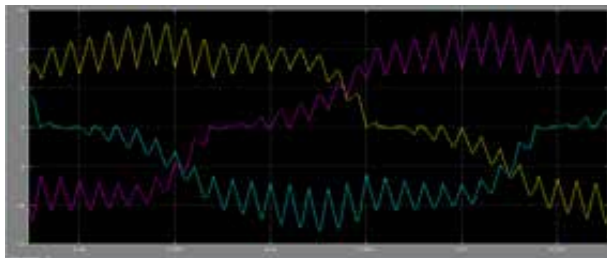

Fig. 8. Stator Current

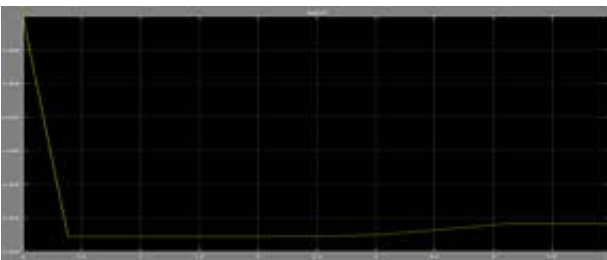

Fig. 9. Battery SOC

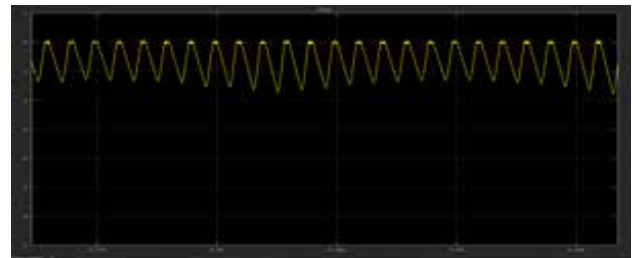

Fig. 10. Electromagnetic torque

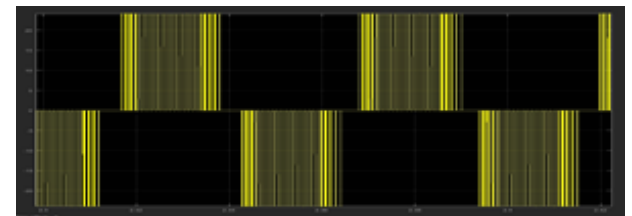

Fig. 11. Line to Line Voltage

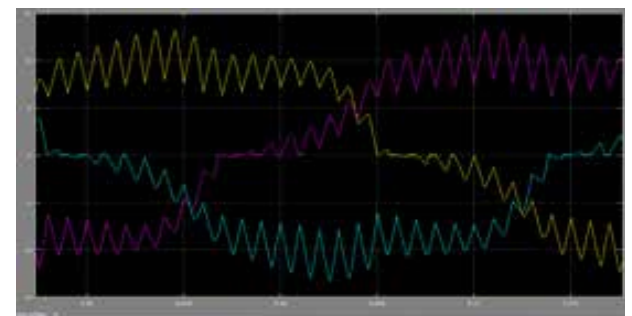

Fig. 12. Stator Current

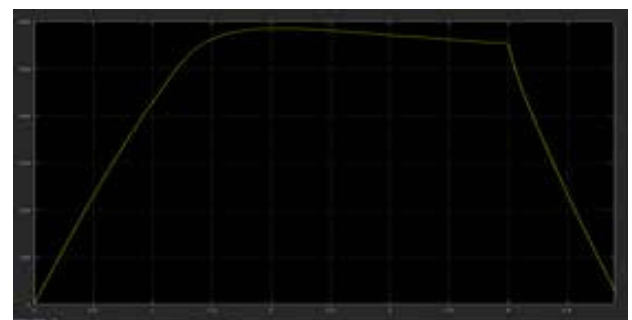

Fig. 13. Rotor Speed graph with regenerative brake applied

**CONCLUSIONS**

The demonstrating of BLDC Motor utilizing a PID controller is exhibited in this paper. Hypothetical examination has checked that the cruising separation, braking torque, and unwavering quality can be enhanced viably inside a variable braking control as indicated

by the driving conditions. All the reenactment results are of hypothetical angle and can be used for down to earth execution of BLDC motor. The criticism flag and substitution component use speed, the situation of the rotor and stator current. From the reproduction results examination, regenerative braking (electric braking) is progressively helpful as no power is squandered however this procedure is costlier as this requires some outside hardware for recovery.

## REFERENCES

1. P. J. Grbovic, P. Delarue, P. Le Moigne, and P. Bartholomeus, "A bi-directional three-level dc-dc converter for the ultra-capacitor applications," *IEEE Trans. Ind. Electron.*, vol. 57, no. 10, pp. 3415–3430, Oct. 2010.
2. F. Wang, X. Yin, H. Luo, and Y. Huang, "A series regenerative braking control strategy based on hybrid-power," in *Proc. Int. Conf. CDCIEM*, 2012, pp. 65–69.
3. N. Mutoh and Y. Nakano, "Dynamics of front-and-rear-wheel-independent-drive-type electric vehicles at the time of failure," *IEEE Trans. Ind. Electron.*, vol. 59, no. 3, pp. 1488–1499, Mar. 2012.
4. M. Cheng, W. Hua, J. Zhang, and W. Zhao, "Overview of stator-permanent magnet brushless machines," *IEEE Trans. Ind. Electron.*, vol. 58, no. 11, pp. 5087–5101, Nov. 2011.
5. Y. Wang and Z. Deng, "Hybrid excitation topologies and control strategies of stator permanent magnet machines for dc power system," *IEEE Trans. Ind. Electron.*, vol. 59, no. 12, pp. 4601–4616, Dec. 2012.
6. C. Sheeba Joice, S. R. Paranjothi, and V. J. Senthil Kumar, "Digital control strategy for four quadrant operation of three phase BLDC motor with load variations," *IEEE Trans. Ind. Informat.*, vol. 9, no. 2, pp. 974–982, May 2013.
7. A. Sathyan, N. Milivojevic, Y.-J. Lee, M. Krishnamurthy, and A. Emadi, "An FPGA-based novel digital PWM control scheme for BLDC motor drives," *IEEE Trans. Ind. Electron.*, vol. 56, no. 8, pp. 3040–3049, Aug. 2009.
8. N. Keskar, M. Batello, A. Guerra, and A. Gorgerino, "Power Loss Estimation in BLDC Motor Drives Using iCalc," *International Rectifier, El Segundo, CA, USA, Rep. AN-1048*, Feb. 2010.
9. K. Yoong, Y. H. Gan, G. D. Gan, C. K. Leong, Z. Y. Phuan, B. K. Cheah, and K. W. Chew, "Studies of regenerative braking in electric vehicle," in *Proc. IEEE Conf. Sustainable Utilization Develop. Eng. Technol.*, Nov. 20/21, 2010, pp. 40–41.
10. J. M. J. Yang, H. L. Jhou, B. Y. Ma, and K. K. Shyu, "A cost-effective method of electric brake with energy regeneration for electric vehicles," *IEEE Trans. Ind. Electron.*, vol. 56, no. 6, pp. 2203–2212, Jun. 2009.
11. N. Mutoh, "Driving and braking torque distribution methods for front-and rear-wheel-independent drive-type electric vehicles on roads with low friction coefficient," *IEEE Trans. Ind. Electron.*, vol. 59, no. 10, pp. 3919–3933, Oct. 2012.
12. C.-H. Huang, W.-J. Wang, and C.-H. Chiu, "Design and implementation of fuzzy control on a two-wheel inverted pendulum," *IEEE Trans. Ind. Electron.*, vol. 58, no. 7, pp. 2988–3001, Jul. 2011.
13. P. J. Grbovic, P. Delarue, P. Le Moigne, and P. Bartholomeus, "The ultra-capacitor based controlled electric drives with braking and ride-through capability: Overview and analysis," *IEEE Trans. Ind. Electron.*, vol. 58, no. 3, pp. 925–936, Mar. 2011.

# Professional Commitment and Spiritual Intelligence of Teachers on the Basis of Age: A Study at the Schools of Kullu and Mandi Districts of Himachal Pradesh

## Jyotika Guleria

Assistant Professor  
Chitkara College of Education  
Punjab  
✉ jyotika.guleria@chitkara.edu.in

## Sangeeta Pant

Dean  
Chitkara College of Education  
Punjab  
✉ sangeeta.pant@chitkara.edu.in

## Parul Sood

Assistant Dean  
Chitkara College of Education  
Punjab  
✉ parul.sood@chitkara.edu.in

## Vani

Assistant Professor  
Chitkara College of Education  
Punjab  
✉ vani.parwez@chitkara.edu.in

## ABSTRACT

The study was designed to examine the relationship of professional commitment and spiritual intelligence of school teachers with regard to age. The sample of the study included 300 school teachers of Kullu and Mandi districts of Himachal Pradesh. The ANOVA was used to prove the hypothesis statistically. The findings of the study revealed statistically significant difference in the Professional Commitment of teachers on the basis of age. However, no significant difference was found in the spiritual intelligence of school teachers on the basis of age.

**KEYWORDS** : *Spiritual intelligence, Professional commitment, Teachers.*

## INTRODUCTION

Commitment of the teachers which is popularly known as 'dedication' influence school children's growth to a great deal. The positive attitude of teachers towards teaching helps the learners to achieve their objectives and goals. Devotion and commitment of the teachers to their profession help the nation to build their future citizens. Right from the elementary to higher level of teaching, competent and engaged teachers are in a continuous endeavour to deliver the quality education. . Therefore, professional commitment not only affects teachers but the educational system as a whole. It is the need of the hour in order to bring refinement and quality in education. (Azkiya, 2016).

In recent years, the construct spiritual intelligence has become to be known as an important part of one's personal and professional life. Spirituality is considered as one of the key factors for the success of the educational

organizations and ultimately for the professional life of the teacher. The spiritual perspective is causing shift in the workplace values promoting cooperation rather than fear at the workplace (Labbs, 1995). Giacalone (2004) stated spirituality in the workplace as a framework that not only provides a value system in an organization creates a culture rich in spiritual values. In the view of Rego and Cunha (2008) when people have high spirituality in the workplace, they may be more responsible and have more loyalty for the organization.

### Professional Commitment

The phrase "professional commitment" consists of two parts that is "professional" and "commitment". The term "profession" as originated in the European literature dates back to the 18th century and refers to the nature or type of profession while "commitment" can refer to someone who is caring, loyal, dedicated, obliged, and devoted to their profession.

The following five significant aspects of teachers' professional commitment have been identified by NCTE (1998).

- **Commitment to the learner:** This dimension includes love for the learner, willingness to assist learners, and care for the learner's overall development.
- **Commitment to Society:** This aspect involves understanding and caring about how teachers contribute to the progress of the society which includes families, communities, and the country.
- **Commitment to the Profession:** This component entails accepting on an internal level the obligations and role of the teaching profession, regardless of how one came to be in it.
- **Commitment to Achieve Excellence:** This dimension covers areas like care and concern for doing everything in the classroom, in the school and the community in the best possible manner. It also includes teacher's involvement in various professional development activities.
- **Commitment to Basic Human Values:** It includes the role model aspect comprising genuine practice of professional values such as impartiality, objectivity, intellectual honesty, national loyalty etc. with consistency.

### Spiritual Intelligence

The philosophical foundation of spiritual intelligence lies in day-to-day dealings or activities. Emmons (2000a, 2000b) viewed spiritual intelligence as an intelligence that predicts the functioning and adaptability of an individual. According to Ingersoll (1998), spirituality is starting to be acknowledged as a concept separate from religion. It is challenging to pin down the ethereal idea of spirituality. Spirituality cannot be fully understood by its definitions. A broad concept, spirituality encompasses many different metaphors such as breath, wind, vigor, and courage. According to Swinton's (2001) conceptualization, it is the bringing and enlivening of spirit in one's life, and it is perceived as an active, passive process. Its foundation is the "breath of life," an individual's affirmation of transcendental connectivity.

Spiritual Intelligence is the ultimate intelligence which we address and solve problems of meaning and

value the intelligence with which we can place our actions and our lives in a wider, richer, meaning-giving context, the intelligence with which we can assess that one course of action or one life path is more meaningful than another (Zohar and Marshall, 1999). Spiritual intelligence has been classified into six dimensions according to Zohar and Marshall (1999). The Inner Self, The Inter-self, Biostoria, Life Perspectives, Spiritual Actualization and Value Orientation.

### Rationale of the study

The present study aimed to find out the dimension wise analysis of professional commitment and spiritual intelligence of school teachers with regard to their age. The study's findings would add a new perspective to stakeholders' understanding of how to choose teachers and delegate responsibilities to them while taking their age into consideration. This would enhance the efficiency of the employees by putting the right person at a right place.

### Statement of the problem

PROFESSIONAL COMMITMENT AND SPIRITUAL INTELLIGENCE OF TEACHERS ON THE BASIS OF AGE: A STUDY IN THE SCHOOLS OF KULLU AND MANDI DISTRICTS OF HIMACHAL PRADESH

### Objective of the study

1. To study the difference in Professional Commitment of teachers on the basis of Age in the select schools of Himachal Pradesh
2. To study the difference in Spiritual Intelligence of teachers on the basis of Age in the select schools of Himachal Pradesh

### 1.5 Hypothesis

1. There is no statistically significant difference in the Professional Commitment of teachers on the basis of Age in the select schools of Himachal Pradesh
2. There is no statistically significant difference in the Spiritual Intelligence of teachers on the basis of Age in the select schools of Himachal Pradesh

### Delimitations of the Study

The study is limited to the schools of Kullu and Mandi districts of Himachal Pradesh.

## LITERATURE REVIEW

Sharma (2016) conducted a study on a sample of 321 teacher educators of Panjab University, Chandigarh to examine the professional commitment of on the basis of age. The study included age groups; below 30 years, between 30-45 years and above 45 years. The study revealed that there was no significant difference between the teachers belonging to the age group below 30 years and between 30-45 years. Furthermore, the study also revealed that there was no statistically significant difference between teacher educators belonging to the age between 30-45 years category and above 45 years category. However, high age group level had high professional commitment as compared to low age group level.

Nayci (2021) examined the professional commitment of primary and secondary school teachers on a sample of 341 teachers Descriptive survey model was used in this research. The sample of the study consisted of 341 teachers in the villages of a province of Southeast region. The data was collected during COVID-19 Pandemic situation and the results revealed that the high professional commitment of primary and secondary school teachers. also, the level of professional commitment differed according to gender, educational qualification of teachers. Moreover, no statistically significant difference according to the school level, seniority, age and marital status was observed.

Mahajan and Kout (2022) conducted a study on the professional commitment of secondary school teachers of Mahja, Malwa and Doaba districts of Panjab. The sample of the study included 960 teachers form government and private schools. The results of the study revealed that private school teachers teaching secondary classes were more committed as compared to the government school teachers teaching same classes in all the dimension of professional commitment; commitment to own profession, commitment to attain excellence, commitment to the learner, to the society and basic human values.

Fischbaugh (2017) conducted a study with aim to investigate whether teacher who attend professional development courses are more committed towards the profession and, are more actively or extensively involved in instructional planning and institutional

development. Though recent studies have indicated a direct link between teacher commitment, school climate, and instruction, professional development activities are traditionally organized and led by school principals. In an attempt to foster teamwork, public school administrators give teachers greater authority.

Hanlon (2006) conducted a multivariate analysis of data collected from U. S. workforce. The study aimed to find out a relationship between age and work commitment with respect to the length of service. The results of the study revealed that there is decline of the work ethics among young employees and the ones expecting retirement in near future.

Gedela, Sharma and Kang (2022) studied the impact of spiritual intelligence on resilience. The sample of the study included 160 students of Panjab Agricultural University, Ludhiana. Equal number of males and females were selected for the study. Moreover, the construct resilience was found to be high in case of female students as compared to males.

Chakma, Majid and Vijaya Lakshmi (2023) conducted a study on 1266 students and 330 teachers. the results revealed that the number of teachers and students falling in low, medium and high levels of Spiritual Intelligence was nearabout equal. Furthermore, there was no relationship between level of spiritual intelligence and designation of the participants. Moreover, significant influence on designation on some of the dimensions of spiritual intelligence was found for which age and educational qualifications might have paled some influence.

Chhabra and Rathore (2022) This paper is an inquiry into the development of spiritual intelligence among teacher educators in order to make them effective. It focuses on the current practices in the realms of teacher education useful in developing spiritual intelligence.

Altalha (2020) conducted a study that aimed to find out effect of spiritual intelligence, gender, age, and specialization on the mental health. The sample of study included 349 male and 643 female students of King Saud University, Riyadh. The results revealed a significant positive relationship between mental health and spiritual intelligence. Furthermore, a positive conjoint effect of spiritual intelligence, gender, age and specializations on mental health was found.



## METHODOLOGY

### Sample

The sample comprised of the 300 teachers from the schools of Kullu and Mandi districts of Himachal Pradesh.

### Research Design

The present study adopted the descriptive study design, which describes the nature of variables under study and their relationship. The study analysed the dimension of Professional Commitment and Spiritual Intelligence on the basis of Age.

### Research Tools

1. Roquan Spiritual Intelligence Test by Zainuddin and Ahmad (2005)
2. Professional Commitment Scale developed by the investigator herself

### Statistical Techniques used

The hypotheses were tested using descriptive and inferential statistics through SPSS mode. ANOVA analysis was carried out to test the statistical significance of hypothesis.

## ANALYSIS AND INTERPRETATION OF DATA

**Table 2: Difference in Professional Commitment on the basis of Age of the respondents (ANOVA)**

	Age	N	Mean	Std. Deviation	F-value	p-value
Moral Code of Conduct	<=30	27	118.778	25.867	2.458	.063
	31-40	125	126.520	17.401		
	41-50	104	124.808	21.110		
	>50	44	118.000	25.000		
Commitment to the Learner	<=30	27	83.370	25.563	3.249	.022*
	31-40	125	96.768	20.148		
	41-50	104	93.827	19.833		
	>50	44	91.000	24.188		
Commitment to the Society	<=30	27	61.926	16.930	2.784	.041*
	31-40	125	68.192	11.984		
	41-50	104	67.058	12.687		
	>50	44	63.273	13.845		

## Descriptive Analysis

**Table 1: Age wise distribution of the respondents**

Age		
	Frequency	Percent
<=30	27	9.0
31-40	125	41.7
41-50	104	34.7
>50	44	14.7
Total	300	100.0

Source: Primary data

**Figure-1 showing Age wise distribution of the respondents**

Table 1 and figure 1 clearly indicate that majority of respondent i.e. 41.7% belonged to 31-40 years age group, 34.7% belonged to 41-50 years age group, 14.7% belonged to more than 50 years age group whereas 9% belonged to <30 years age group.

## Inferential Analysis

The first objective of the study was to study the difference in Professional Commitment of teachers on the basis of Age in the select schools of Himachal Pradesh and the hypothesis was;

There will be no statistically significant difference in the Professional Commitment of teachers on the basis of Age in the select schools of Himachal Pradesh

Commitment to the Profession	<=30	27	93.815	20.805	2.178	.091
	31-40	125	100.448	20.832		
	41-50	104	99.317	17.768		
	>50	44	92.864	19.828		
Commitment to Achieve Excellence	<=30	27	85.185	22.968	2.330	.074
	31-40	125	90.304	16.624		
	41-50	104	92.712	17.536		
	>50	44	85.455	20.576		
Professional Commitment	<=30	27	443.074	68.107	6.725	.0001**
	31-40	125	482.232	49.078		
	41-50	104	477.721	48.487		
	>50	44	450.591	69.338		

Source: Primary data

\*The mean difference is significant at the 0.05 level.

Table 2 indicated that there is no significant difference in the Moral Code of Conduct (F-value 2.458), Commitment to the Profession (F-value 2.178) and Commitment to Achieve Excellence (F-value 2.330) as dimensions of Professional Commitment.

Table 2 also indicated there is a significant difference in the Commitment to the Learner (F-value 3.249), Commitment to the Society ((F-value 2.784) and the overall Professional Commitment (F-value 6.725) as dimensions of Professional Commitment.

Furthermore, Table 2 also indicates that in case of overall Professional Commitment, mean scores and standard deviation for <30 years age group of school teachers were 443.07 and 68.10, mean scores and standard deviation for 31-40 years age group of school teachers were 482.23 and 49.07, mean scores and standard deviation for 41-50 years age group of school teachers were 477.72 and 48.48 and mean scores and

standard deviation for >50 years age group of school teachers were 450.59 and 69.33. The F-value 6.725 which is significant at 0.01 level. When mean scores were compared, it was found that 31-40 years age group was doing better in overall Professional Commitment in comparison to other age groups of school teachers.

Therefore, the hypothesis 1 'There is no statistically significant difference in the Professional Commitment of teachers on the basis of Age in the select schools of Himachal Pradesh' is rejected.

The second objective was to study the difference in Spiritual Intelligence of teachers on the basis of Age in the select schools of Himachal Pradesh and the hypothesis was;

There is no statistically significant difference in the Spiritual Intelligence of teachers on the basis of Age in the select schools of Himachal Pradesh

**Table 3. Difference in Teacher – Spiritual Intelligence on the basis of Age (ANOVA)**

		N	Mean	Std. Deviation	F-value	p-value
The Inner-self	<=30	27	35.407	5.793	3.106	.027*
	31-40	125	38.104	5.158		
	41-50	104	38.673	4.838		
	>50	44	37.909	4.108		

The Inter-self	<=30	27	78.519	6.986	.551	.648
	31-40	125	80.224	8.382		
	41-50	104	79.913	8.049		
	>50	44	78.886	6.962		
Biostoria	<=30	27	22.481	4.501	1.482	.220
	31-40	125	24.264	3.781		
	41-50	104	23.913	4.336		
	>50	44	24.045	3.403		
Life Perspectives	<=30	27	41.296	4.513	2.125	.097
	31-40	125	43.120	4.232		
	41-50	104	42.558	4.478		
	>50	44	41.568	4.834		
Spiritual Actualization	<=30	27	87.185	9.560	1.151	.329
	31-40	125	90.416	8.822		
	41-50	104	90.058	9.506		
	>50	44	88.727	8.940		
Value Orientation	<=30	27	50.481	5.287	3.505	.016*
	31-40	125	50.464	5.839		
	41-50	104	52.567	4.942		
	>50	44	52.159	4.680		
Spiritual Intelligence	<=30	27	315.370	26.682	1.606	.188
	31-40	125	326.592	27.798		
	41-50	104	327.683	27.483		
	>50	44	323.295	26.785		

Source: Primary data

\*The mean difference is significant at the 0.05 level.

Table 3 indicated that there is no significant difference in the Inter-self (F-value .551), Biostoria (F-value 1.482), Life Perspective (F-value 2.125), Spiritual Actualization (F-value .329) as dimensions of Spiritual Intelligence and overall Spiritual Intelligence (F-value 1.606) on the basis of age.

Table 3 also indicated there is a significant difference in the Inter-self (F-value 3.106) and Value Orientation (F-value 3.505) as dimensions of Spiritual Intelligence.

Furthermore, Table 3 indicated that for overall Spiritual Intelligence, mean scores and standard deviation for <30 years age group of school teachers were 315.37 and 26.68, mean scores and standard deviation for 31-

40 years age group of school teachers were 326.59 and 27.79, mean scores and standard deviation for 41-50 years age group of school teachers were 327.68 and 27.48 and mean scores and standard deviation for >50 years age group of school teachers were 323.29 and 26.78. When mean scores were compared, it was found that 41-50 years age group was doing little better in overall Spiritual Intelligence in comparison to other age groups of school teachers.

Therefore, Hypothesis 2 There is no statistically significant difference in the Spiritual Intelligence of teachers on the basis of Age in the select schools of Himachal Pradesh is not rejected.

## RESULTS AND CONCLUSIONS

### Professional Commitment

The results of the study revealed that there was no significant difference in the Moral Code of Conduct, Commitment to the Profession, Commitment to the Society, and Commitment to Achieve Excellence as dimensions of Professional Commitment of school teachers of various age groups. When mean scores were compared, it was found that 31-40 years age group was doing better in these dimensions of Professional Commitment in comparison to other age groups of school teachers.

The study revealed a significant difference in the Commitment to the Learner as a dimension of the Professional Commitment the overall Professional Commitment of school teachers of various age groups and 31-40 years age group was doing better in overall Professional Commitment in comparison to other age groups of school teachers. So, it was concluded that Professional Commitment of teachers teaching in schools was influenced by their age.

### Spiritual Intelligence

The results of the study revealed that there was no significant difference in The Inter-self, Biostoria, Life Perspective and Spiritual Actualization as a dimension of Spiritual Intelligence of school teachers of various age groups.

The results revealed that there was a significant difference in The Inner Self, Value Orientation as a dimension of Spiritual Intelligence of school teachers of various age groups. In addition, there was no significant difference in the overall Spiritual Intelligence of school teachers of various age groups. However, it was found that 41-50 years age group was doing little better in overall Spiritual Intelligence in comparison to other age groups of school teachers. So, it was concluded that Spiritual Intelligence of teachers teaching in schools was not influenced by their age.

## EDUCATIONAL IMPLICATIONS

- Teachers falling in the category below 30 years of age group should be mentored by their seniors to develop interest in the profession of teaching.

- Teachers falling in the age group between 31-40 should be assigned most of the important responsibilities of teaching profession as they have zeal and energy to carry out a variety of tasks and are more committed towards their profession as compared to other age groups.
- Teachers falling in the age group between 41-50 years should be made mentors and guides to their juniors to solve day-to-day challenges that they face in their profession
- Teachers falling in the age group between 41-50 years should be made buddy teachers to senior age group teachers so as to develop healthy inter-personal relationship and in turn learn from their vast experience.
- Teachers in the age group 'above 50 years' should be relieved from such academic and administrative duties which involve tiresome physical work.
- Teachers in the age group above 50 years should be given the role of mentors, guides, subject experts etc.

## REFERENCES

- Altalha, G. S. S. (2020). The Role of Spiritual Intelligence, Age, Gender, and Specialization in Predicting University Students' Mental Health. Retrieved from [https://www.eimj.org/uploade/images/photo/The\\_Role\\_of\\_Spiritual\\_Intelligenc e..pdf](https://www.eimj.org/uploade/images/photo/The_Role_of_Spiritual_Intelligenc e..pdf)
- Azkiya, W. (2016), "Professional Commitment of Secondary School Teachers in Relation to Their Gender and Area: A Comparative Study", *Global Journal for Research Analysis (GJRA)*, Vol. 5, Issue 7, pp. 264-265.
- Chakma, C., Majid, I., & Vijaya Lakshmi, Y. (2023). Spiritual Intelligence of Teachers and Students. *Education and Society*, 21-27. Retrieved from [https://papers.ssrn.com/sol3/papers.cfm?abstract\\_id=4390707](https://papers.ssrn.com/sol3/papers.cfm?abstract_id=4390707)
- Chhabra, M. & Rathore, M. (2022). Developing Spiritual Intelligence among Teacher Educators: Current Practices in Teacher Education. *Educational Resurgence Journal* 5 (1). Retrieved from <https://www.coed.dypvp.edu.in/educational-resurgence-journal/documents/july-2022/7.pdf>

5. Emmons, R.A. (2000) Is Spirituality an Intelligence? Motivation, Cognition, and Psychology of Ultimate Concern. *International Journal for the Psychology of Religion*, 10, 3-2. Retrieved from <https://psycnet.apa.org/record/2000-03802-001>
6. Emmons, R. (2000b). Spirituality and Intelligence: Problems and Prospects. *International Journal for the Psychology of Religion*, 10 (1), 57-64. doi . org/10.1207/S15327582IJPR1001\_6
7. Fischbaugh, R. (2017). How Are School Climate, Teacher Commitment, and Instruction Valued through Teacher-Led Professional Development. Retrieved from <http://d-scholarship.pitt.edu/33151/1/RFdissertation8.19.17.pdf>
8. Gedela, Sharma, S. & Kang, T. K. (2022). Relationship of spiritual intelligence on resilience among male and female university students: A comparative study *Navya. The Pharma Innovation Journal* 2022; SP-11(12): 1198-1202.
9. Hanlon, M. D. (2006). Age and Commitment to Work: A Literature Review and Multivariate Analysis. doi 10.1177/0164027586008002006.
10. Ingersoll R. E. (1998). Refining Dimensions of Spiritual Wellness: A Cross- traditional Approach. *Journal of Counselling and Development*, 42, 3. doi . org/10.1002/j.2161-007X.1998.tb00421.x
11. Ingersoll, R. E. (2000). Spirituality, religion, and counseling: Dimensions and relationships. *Counseling and Values* 38, 98-111. <https://doi.org/10.1002/J.2161-007X.1994.TB00827.X>
12. King, D. B. (2010). Personal meaning production as a component of spiritual intelligence. *International Journal of Existential Psychology and Psychotherapy*, 3 (1). Retrieved from <https://www.meaning.ca/web/wp-content/uploads/2019/10/147-13-509-1-10-20171212.pdf>
13. Labbs, J.J. (1995). 'Balancing Spiritually at work', *Personnel Journal*, vol 74. No.9., 60-76.
14. Nayci, O. (2021). Examination of professional commitment levels of primary and secondary school teachers during Covid-19 pandemic period. *International Journal of Curriculum and Instruction* 13(2), 1825–1844. Retrieved from ERIC database EJ1292151.
15. National Council for Teacher Education (1998). Competency Based and Commitment- oriented Teacher Education for Quality School Education. Retrieved from <https://ncte.gov.in/Website/PDF/AnnualReport/1998-99.pdf>
16. Rego, A., & Pina e Cunha, M. (2008). Workplace spirituality and organizational commitment: An empirical study. *Journal of Organizational Change Management*, 21(1), 53–75. <https://doi.org/10.1108/09534810810847039>
17. Sharma, S. (2016). A comparison of professional commitment of low age group (Below 30 years), average age group (30-45 years) and high age group (Above 45 years) of teacher educators belonging to Panjab University, Chandigarh. Retrieved from <https://www.allresearchjournal.com/archives/2016/vol2issue3/PartL/2-12-118-124.pdf>
18. Swinton, J. (2002). Spirituality and Mental Health Care: Rediscovering a 'Forgotten' Dimension. <http://dx.doi.org/10.1192/pb.26.3.118>
19. Zohar, D., Marshall, I. N., & Marshall, I. (2000). *SQ: Connecting with Our Spiritual Intelligence*. London, USA: Bloomsbury Publishing. Retrieved from <https://www.alisonmorgan.co.uk/Books/Zohar%202000.pdf>



# Integration of Sustainable Tourism Centered Curriculum at High School Level in Goa

**Pranjali .U. Dhargalkar**

Assistant professor

Post Graduate and Research Department in Education

GVM's Dr. Dada Vaidya College of Education

✉ prajdhargalkar7@gmail.com

## ABSTRACT

Goa, a small state situated on the west coast of India, between the border of Maharashtra and Karnataka is famous for its beaches and places of worship. Tourism is its primary industry. Foreign tourists, mostly from Europe, arrive in Goa in winter, whilst the summer and monsoon seasons see many Indian tourists. While the people of Goa can be justifiably proud of the vast social and economic progress achieved over the last five decades, there is an observable rapid environmental destruction along with several other challenges at this point of time. Goa being a small State, has limited carrying capacity in terms of its size, the facilities available and ecological fragility. Therefore the policy makers in Goa and elsewhere in the world are realising the need for sustainable tourism development. Many educational institutions around the globe aim to integrate sustainability into their tourism and hospitality curricula following the need for sustainable tourism development. Teaching and learning methods play an important role in promoting sustainability in tourism education. The aim of this paper is to discuss how sustainability related to tourism can be implemented into higher education curriculum and what changes are necessary within the school strategy, organizational structure as well as within the curricula and teaching strategies. Learning for sustainable tourism is not about getting equipped with knowledge about theories related to sustainable tourism but changing mind sets and engaging students actively in matters relating to sustainable future in tourism. It is concluded that most learning takes place through the "hidden" curriculum. Staff and educators act as role models for education for sustainable development and students become inspired and motivated by their actions related to sustainability.

**KEYWORDS** : *Sustainable tourism, Curriculum development, Holistic education, Values-based education, Tourism centred curriculum, High school.*

## INTRODUCTION

Tourism is one of the fastest growing industry in the world. In the 60's, tourism was adopted as a key sector for Goa's development, primarily because of its potential to generate employment in a State with an educated workforce and limited industrial growth. Today, almost one third of Goa's population is engaged in tourism related activities. Major tourist attractions in Goa include Bom Jesus Basilica, Fort Aguada, and a heritage museum. The Churches and Convents of Goa have been declared a World Heritage Site by UNESCO. Other than the tourist attraction Goa is also known to be the party hub of India.

Tourism has transformed Goa into a cosmopolitan city. The conservation of social heritages, cultural events, and skills, first-hand knowledge about foreign cultures, improvement in the infrastructure, Economic growth, employment opportunities etc., are the positive impacts of tourism on the society of Goa. However, tourism also has adverse impact that are in multifold. The influx of foreign tourist has led to increased cost of living and increased property prices which has made it difficult for locals to afford to live in the state. It has also led to degradation of natural and cultural resources. Goan youth is affected by the influence of western culture. Commercialization and vulgarization of local folk

traditions including art, culture, and festivals has led to gradual destruction of the purity and originality of these unique traditional assets. Tourist destinations especially coastal areas have become a safe place to cover up things such as money laundering, drugs, prostitution, and trafficking in women and children. Tourism development in Goa has caused the forcible eviction of coastal communities especially the vulnerable indigenous groups from their traditional lands, .

Young kids and the future generations of Goa are at the receiving end of the adverse effects of tourism. Therefore there is a need to promote more responsible and sustainable tourism. Sustainable tourism is a form of tourism that aims to minimize the negative impacts and maximize the positive benefits of travel on the environment, society, and economy. It is a growing trend in the tourism industry, as more travellers and destinations become aware of the need to protect the planet and its people. The only way to target the young minds into opting for sustainable development is education. The goal of this study is to discuss and suggest strategies for sustainable tourism centred curriculum at the high school level. The question addressed is whether or not it is now necessary to change or adapt our teaching strategies to be able to teach sustainable tourism at educational institutions.

**GROWTH OF TOURISM IN GOA**

In Goa, tourism started post liberation with discovery of pristine silver sand beaches of Goa by the ‘Hippies’ in late 1960’s. The Hippies who came to Goa were willing to adjust on bare minimum resources, facilities and infrastructure. The State government sensed the economic potential of tourism and promoted tourism as an industry in 1980s. This led to creation and improvement of infrastructure related to tourism in Goa. The number tourist visiting the State have significantly increased from 7,75,212 in 1975 to 31,21,473 in 2013.

**Table I**  
**Average Growth Rate to Tourist Inflow**

	Domestic	Foreign	Total
1985-90	2.67	2.59	2.66
1990-2000	2.2	12.9	3.61
2000-2010	8.4	4.5	7.5
2010-2013	5.5	7.1	5.4

As far as country wise tourist inflow is concerned the largest number i.e 33.05 percent of tourist visiting Goa are from Russia (33.05% followed by U.K (29.53 %), Germany (9.43 %) Finland (5.2 %) France (4.19 %) and rest are from other countries of the world.(see Table II)

**Table II**

**Country-wise % Tourist Visiting Goa in 2013**

Sr. No.	Countries	No. of tourist Arrived	%
1	U.K.	145431	29.53
2	Russia	162746	33.05
3	Germany	46472	9.43
4	Finland	25643	5.2
5	France	20618	4.19
6	Others	91412	18.6

Source: Dept of Tourism, Goa

**Table III**

**Arrivals by charter flights season**

Year	No.of flights	Passengers
1985-86	24	3568
1990-91	41	5815
1995-96	337	75694
2000-01	419	116992
2005-2006	719	180310
2010 - 2011	900	171367
2011 - 2012	910	169006
2012 - 2013	996	215304
2013 - 2014	1128	261452

Source: Dept of Tourism, Goa

The Goa state tourism has welcomed 10 million visitors since March, surpassing pre-pandemic levels. The projected number of visitors for 2023 is expected to be 30% higher than the 8.1 million tourist’s arrival in 2019.

**OVER TOURISM AND ITS EFFECTS**

The environmental challenges faced by Goa are numerous. The over-utilized waste management system, lack of education and awareness about environment conservation, dumping of solid and liquid wastes, limited enforcement of deterrent measures against

beach pollution, water bodies, and ecologically sensitive areas, and violation of coastal zone regulation are some of the pressing challenges of Goa tourism. Mass tourism in Goa exceeded carrying capacity and the tourist destinations are overcrowded, water resource in many coastal areas is stressed and vegetation is destroyed due to tourism-related activities, The indiscriminate construction activities along the coastal areas have led to the problem of loss of sand dunes, increasing tidal waves, soil erosion, and deposition. The scarce land and land resources are extracted and exploited at a large scale for tourism in Goa. The heritage sites have almost lost their value and identity due to the absence of adequate mechanisms for the conservation and development of heritage sites.

Tourism puts pressure on transportation infrastructure and the Government is not able to meet the travel requirements of both the local community and tourists. The absence of an efficient public transport system has led to the growth of motorbikes and cars substantially, which in turn has aggravated environmental pollution such as air pollution and noise pollution. Waste generation and littering have become major problems in Goa and there is no mechanism existing in Goa for managing and recycling huge quantities of liquid and solid waste generated by the tourism industry, The government has initiated setting up waste recycling plants in Saligao and South Goa and Central Goa.

## EDUCATION AND TOURISM

It is widely agreed that education and training are important to the achievement of sustainable tourism. Children at school who may assume the roles in the future tourism industry or otherwise should be the prime focus when imparting knowledge regarding sustainable tourism. They are likely to have a different perspective on the definitions of terms, moral arguments and scientific evidence in ways which support their existing view of the problems and priorities of tourism. There is uncertainty and contestation, even about the meaning of "sustainable tourism," and it is likely to persist for the foreseeable future. Therefore, environmental education and training which helps to create and support sustainable tourism is the need of the hour. Environmental educators and trainers must address variety of preconceived ideas relating to tourism and tourism development. Education

relating to Tourism at high school level can help in acquiring the knowledge, skills, and attitudes to plan, operate, and manage tourism activities and enterprises. This education can be essential in promoting and implementing sustainable tourism practices. It equips students with the competencies and values to understand the complex and interrelated impacts of tourism on the environment, society, and economy.

It is necessary to change or adapt our teaching strategies to be able to teach sustainable tourism at educational institutions. There are two important aspects to consider when addressing education for sustainable development. First, there are several definitions of the concept of sustainability, but there are still no ideal strategies which would guarantee achieving the optimum state sustainability. Yet, we still have to explore our tactics towards more sustainable futures as "there is international consensus that achieving sustainable development is essentially a process of learning" Second, sustainable development "requires a shift in the mental models which frame our thinking and inform our decisions and actions" It is necessary to question the assumptions on which our current thinking is based, and to contemplate different approaches.

## SUSTAINABLE TOURISM CENTRED CURRICULUM

It is necessary to change or adapt our teaching strategies to be able to teach sustainable tourism at educational institutions. There are two important aspects to consider when addressing education for sustainable development. First, there are several definitions of the concept of sustainability, but there are still no ideal strategies which would guarantee achieving the optimum state sustainability. Second, sustainable development "requires a shift in the mental models which frame our thinking and inform our decisions and actions". It is necessary to question the assumptions on which our current thinking is based, and to contemplate different approaches.

Tourism management education can use various methods and approaches to foster sustainable tourism practices among students. Incorporating sustainability as a core value and an important theme in the curriculum and learning outcomes is essential, along with providing

theoretical and practical knowledge on the concepts, tools, and best practices of sustainable tourism. Experiential and project-based learning activities like case studies, field trips, simulations, internships, and consultancy projects can help students apply their knowledge to real-world situations. Encouraging students to reflect critically and creatively on their own and others' experiences and assumptions while developing an action plan for sustainable tourism is also beneficial. Moreover, facilitating students' participation in local and global networks that support sustainable tourism initiatives, such as the United Nations World Tourism Organization, the Global Sustainable Tourism Council, and the International Ecotourism Society can further promote sustainability.

#### **Suggested strategies for incorporating sustainability into the curriculum**

Education for sustainable development is strongly aligned with active and participatory learning processes, because “they encourage learners to ask critical reflective questions, clarify values, envision more positive futures, think systemically, respond through applied learning and explore the dialectic between tradition and innovation”. Sustainable tourism education can be best transacted through group discussions, which encourage listening and self-reflection, debates for developing arguments, stimulus activities such as watching films or reading a newspaper article in order to stimulate discussion or the use of critical incidents allowing students to reflect their actions on the basis of their moral or ethical attitude.

Case Studies as a research strategy and fieldwork are other popular choices of pedagogy for teaching sustainable tourism. They provide the opportunity for students to investigate local issues and work collaboratively with local stakeholders in order to find solutions. Both serve as catalysts for developing students' critical thinking skills in order to understand the complexity of sustainable tourism. Furthermore they can help to influence students' emotions towards a more sustainable development. Through their investigations the students learn about the different perspectives of tourism stakeholders in a particular location, how they were interconnected and what the challenges for sustainable tourism development are. They can developed strong opinions about the necessity

of collaboration .Interactive technologies, social networking and the internet provide very important tools for engaging students in learning sustainable tourism. While students enjoy the course and perceive it as interesting, fresh and innovative ideas add to the global dimension. learning also takes place implicitly through the “hidden” curriculum. Sustainable tourism can be made a part of science and geography course. Staff and educators act as role models for education for sustainable development and students become inspired and motivated by their actions related to sustainability.

#### **CONCLUSIONS AND SUGGESTIONS FOR FUTURE STRATEGIES :**

To conclude, tourism in its present form has imposed greater cost on Goans than benefits. The growth of tourism now is not possible to reverse but at least care has to be taken to see that economic fruits of tourism percolate to the local community.

1. The Government of Goa has to change its strategy from ‘commercial tourism’ to ‘community based tourism’ or “ sustainable tourism” and promote more of Eco-tourism, Adventure tourism, pilgrim tourism, hinterland tourism ,medical or health tourism and hydel tourism.
2. Maintaining a new beach cleanliness task force that will be responsible for keeping the beaches clean and banning hawkers, vendors on the beaches, and also banning use of plastic bags on the beaches should be introduced.
3. Plantation of coconut trees, at 50m from high tide line and beyond to prevent sand erosion.
4. Each Hotel or other structure facing the beach as also elsewhere should have adequate sewage treatment system and preferably biological treatment plants should be strictly enforced for such beach side hotels. Recently the Goa State Pollution Control Board has taken a step in the right direction by charging hotels with rooms of 25 and above with pollution NOC fee of 1 percent of the total value of the hotel property.

Sustainability should be taught at the very beginning of learning because young minds can be moulded more easily. Sustainable Tourism management

education can bring numerous advantages to students, the tourism industry, and society. For instance, it can enhance students' employability and career prospects, as sustainable tourism is highly valued by employers, customers, and regulators. Furthermore, it can improve students' personal and professional development, as sustainable tourism requires and encourages a range of cognitive, social, and emotional skills. Additionally, it can contribute to students' civic and global citizenship by raising their awareness of local and global issues and motivating them to take action for positive change. Additionally, sustainable tourism can advance the industry's competitiveness and resilience by reducing costs, risks, and conflicts as well as increasing quality, innovation, and differentiation. Finally, it can support the society's sustainable development goals by contributing to environmental conservation, social inclusion, and economic prosperity of destinations and regions.

#### REFERENCES:

1. Census of India. (2011). Directorate of Census Operations. Goa: Panaji- Goa.  
Consulting Engineering Services (I) Ltd. (2001). Tourism Master Plan: Goa 2011. Department of Tourism Government of Goa.
2. Government of Goa (2010). Tourist Statistics 2010. Department of Tourism Panaji- Goa.
3. Government of Goa, Daman and Diu (1971). Ten Years of Liberation: 1961-1971. Government of Goa, Daman and Diu, Department of Information and Tourism, Panaji.
4. Government of Goa, Daman and Diu. (1978). Perspective Plan, 1978-79 to 1992-93', June, Administrative Staff College, Hyderabad.



# Rethinking Education through an Outcome-Based Education: A Case Study

**Pruthviraj Chavan**

✉ pruthvirajchavan2002@gmail.com

**Akash Sakhare**

✉ aakashsakhare57@gmail.com

**Suresh Mane**

✉ mane.suresh@gmail.com

**Shivaleela Arlimatti**

✉ sarlimatti@gmail.com

**Ganesh Rathod**

✉ ganeshrthd883@gmail.com

Dr. D. Y. Patil Pratisthan's College of Engineering, Kolhapur  
Affiliated to Shivaji University  
Kolhapur, Maharashtra

## ABSTRACT

Traditional education methods often face challenges in effectively engaging students and maximizing learning outcomes. This study investigated the impact of Activity-Based Learning (ABL) compared to traditional teaching approaches on eighth-grade students' learning in Data Science. Involving 80 students at D Y Patil Vidyaniketan assigned to ABL and Traditional method of teaching, the research employed a six-month intervention and post-training test assessments. Analysis of test scores revealed significant learning gains across both groups, with the ABL group outperforming their counterparts. The ABL group demonstrated a remarkable 25% increase in average Data Science scores compared to the traditional group. Observations confirmed the effective implementation of ABL activities, critical thinking, and collaboration within group. These findings provide compelling evidence that ABL, can significantly enhance student learning outcomes.

**KEYWORDS** : *Outcome-based education, Activity-based learning, Student learning engagement.*

## INTRODUCTION

The landscape of education stands poised on the precipice of change. Traditional models, built on rote memorization and passive knowledge transmission, are increasingly failing to equip students with the skills and competencies needed to thrive in a rapidly evolving world. This is particularly true for high school students, who face the daunting task of navigating a complex world brimming with challenges and opportunities [1] [2]. It is within this context that we must ask: is the current education system truly serving our students well?

This research delves into a critical question: can a shift towards an Outcome-Based Education (OBE) model, emphasizing ABL, significantly impact student learning and engagement in high schools? Traditional methods,

often characterized by lectures and textbooks, prioritize knowledge acquisition over skill development, leaving students disengaged and questioning the relevance of their education [3] [4]. ABL places the student at the center of the learning process, fostering critical thinking, problem-solving, collaboration, and communication through engaging activities [5] [6]. By focusing on desired learning outcomes, OBE offers a promising avenue for rethinking education and equipping students with the tools they need to navigate the complexities of the 21st century.

### Research Questions

- Does ABL outperform traditional methods in terms of knowledge retention, critical thinking, and problem-solving skills among high school students?

- To what extent does ABL foster collaboration and communication skills compared to traditional approaches?
- Does ABL enhance student engagement and motivation in the classroom?

Using observations as our primary methodology, we will delve into the dynamic classrooms where ABL thrives, witnessing firsthand the impact of this transformative approach on student learning and engagement. By comparing these observations to those of traditional classrooms, we hope to shed light on the potential of ABL to revolutionize high school education and empower students to become active participants in their own learning journeys.

This research holds the potential to offer valuable insights for educators, policymakers, and stakeholders invested in creating a more meaningful and impactful learning experience for high school students. By embracing an outcome-based approach and prioritizing ABL, we can unlock the full potential of our students and prepare them to become confident, critical thinkers, and engaged citizens equipped to tackle the challenges and seize the opportunities of the future.

### Objectives of the paper

- To compare the effectiveness of ABL with traditional teaching methods in high school education through the lens of OBE and its impact on student learning and engagement specifically focusing on knowledge retention critical thinking and problem-solving skills collaboration and communication skills alongside student engagement and motivation within the classroom environment.
- To analyze and understand how an ABL approach with activity-based learning can influence student learning outcomes.
- To provide evidence and insights on the potential benefits of shifting towards an OBE and ABL model for high school education.
- To contribute to the ongoing discussion on education reform by offering a valuable research-based perspective on rethinking and enhancing how we educate high school students.

## METHODOLOGY

This study examined the effectiveness of ABL in enhancing student learning outcomes compared to traditional teaching methods, focusing specifically on Data Science education for eighth-grade students. The research was conducted at D Y Patil Vidyaniketan, involving a six-month intervention and data collection process outlined below.

### Participants

- A total of 80 eighth-grade students were considered for the study.
- Participants were trained for 6 months:

### Data Collection

- Traditional method and ABL Method: Both groups completed standardized Data Science knowledge tests after the six-month intervention period.
- Classroom Observations: Researchers conducted regular observations in 8th grade class to document the implementation of ABL activities.

### Data Analysis

class test marks (after 6 months of ABL training) were considered for analysis of the data, and impact of ABL.

### Interpretation and Conclusion

Draw conclusions about the effectiveness of ABL compared to traditional methods-based class test marks data analysis.

## RESULTS AND DISCUSSION

The graph in Figure 1 depicts the significant positive impact of ABL compared to traditional teaching methods on student performance in an OBE framework. It shows the average scores of 80 eighth-grade students at D Y Patil Vidyaniketan over a six-month period. Students in the ABL group consistently outperformed their counterparts in the traditional group across all subjects measured.

Students in the ABL group outperformed students in the traditional group. The average scores for the ABL group were higher than the average scores for the traditional group in the test after the six-month period. This suggests that the ABL intervention had

a positive impact on student learning outcomes. ABL students demonstrated a 25% increase in average scores compared to the traditional group as shown in figure 2. These findings suggest that ABL, when implemented within an OBE framework, can effectively enhance student learning outcomes across various disciplines.

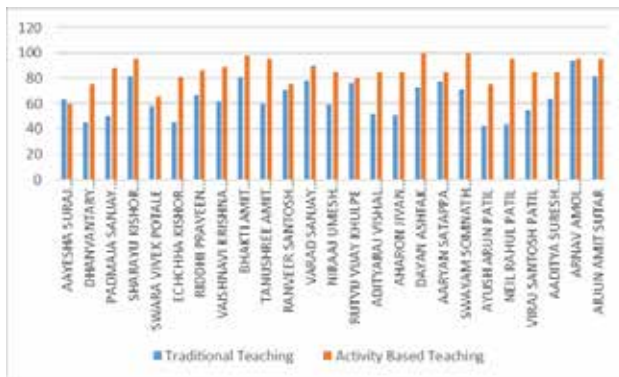

Figure 1 Comparison of Traditional Vs ABL method

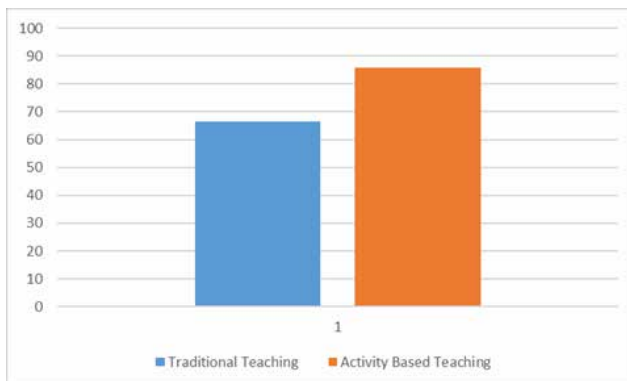

Figure 2 Percentage of ABL Vs Traditional Teaching Methods

The above graphs suggest that ABL is an effective teaching method that can help students improve their learning outcomes in learning the content. However, it is important to note that this is just one study, and more research is needed to confirm these findings.

## IMPACT OF THE STUDY

The results of this study provide compelling evidence that ABL, when implemented within an OBE framework, can significantly improve student learning outcomes compared to traditional teaching methods. The observed advantages of ABL can be attributed to several factors:

- **Active engagement:** ABL activities promote active participation and hands-on learning, fostering deeper understanding and knowledge retention compared to passive lectures in traditional methods.
- **Development of critical thinking and problem-solving skills:** ABL often involves real-world scenarios and collaborative projects, encouraging students to think critically, analyze information, and solve problems independently and collaboratively.
- **Alignment with OBE principles:** ABL activities are directly designed to address specific learning outcomes defined within the OBE framework, ensuring a clear connection between teaching and learning objectives.
- **Increased motivation and engagement:** ABL's interactive nature and focus on student agency can lead to higher levels of motivation and engagement, translating into improved academic performance.

The findings align with existing research suggesting that ABL can be a valuable tool for enhancing student learning and engagement in various educational settings. However, there are some limitations: Implementing ABL effectively requires well-trained teachers and adequate resources for designing and facilitating engaging activities. Traditional assessments might not fully capture the skills and knowledge developed through ABL, necessitating the development of more holistic assessment methods.

## CONCLUSION

The present study has shed light on the transformative potential of ABL in empowering middle school students. The observed advantages, reflected in significantly higher learning outcomes and deeper understanding for the ABL group compared to their traditionally-taught counterparts, paint a compelling picture for embracing ABL as a potent pedagogical tool. The key driver of ABL's success lies in its ability to shift the learning paradigm from passive absorption to active engagement. By immersing students in hands-on activities, collaborative projects, and real-world scenarios, ABL fosters critical thinking, problem-solving, and communication skills, all crucial attributes for navigating the complexities of the 21st century. The data suggests that ABL fuels intrinsic motivation and fosters a love for learning, a

factor often lacking in traditional settings. This study serves as a springboard for educators, policymakers, and researchers to critically examine and potentially embrace ABL. By prioritizing active learning, collaboration, and real-world application, ABL equips students with the essential skills and knowledge to not only excel in academic pursuits but also become confident, innovative, and responsible citizens in a technology-driven world.

## REFERENCE

1. Carbonneau, K. J., & Marley, S. C. (2013). Activity-based learning strategies. In *International guide to student achievement* (pp. 282-284). Routledge.
2. Jonassen, D. H. (2000). Revisiting activity theory as a framework for designing student-centered learning environments. *Theoretical foundations of learning environments*, 89, 121.
3. Stewart, G., Medland, R., & Howard, Z. (2014). Using collaborative and activity-based learning for engaging IT students.
4. Pokhrel, T. R. (2023). Activity based mathematics instruction: Experiences in addressing the 21st-century skills. *Journal of Mathematics Education*, 11(1), 46-61.
5. Subbaraman, S., Jagtap, R. R., & Shinde, S. S. (2013, December). Outcome based learning: A case study. In *2013 IEEE International Conference in MOOC, Innovation and Technology in Education (MITE)* (pp. 375-379). IEEE.
6. Ross, V. (2012). From transformative Outcome Based Education to blended learning. *Futures*, 44(2), 148-157.

# Online Academic and Administrative Audit: Score Card for Educational Institutions

**Chetna Pralhad Sonkamble**

Associate Professor  
Department of Education  
Shivaji University  
Kolhapur  
✉ yaadni6@gmail.com

**Rupali Ganpatrao Bharmal**

Research Student  
Shivaji University  
Kolhapur  
✉ rupalichougule1982@gmail.com

## ABSTRACT

The New National Education Policy 2020 (NEP 2020) proposed the need to revamp education that would address both employment and employability and in view of the national goals of the country. NEP 2020, suggest a stage wise mechanism to attain minimum benchmarks for accreditation to become autonomous institutions. Higher education plays very important role in country's overall development and its role is to give quality education and research opportunities to youth for self- sustainability and employability and it can be achieved through Online Academic and Administrative Audit which fundamentally aims to asses' attainment of goals set by the institutions by emphasizing not only on 'what' but equally on 'how' and evaluation of operations and measurement of indicators to prepare the Institution for Required Changes. Academic and Administrative Audit Apprises the quality of academics by process of self-Evaluation carried out by the Institution. Online AAA will contribute to the movement of getting Paperless, minimizing human resource, financial burden, promote transparency in maintaining record which will ultimately save nature and ultimately going to serve for the thought of autonomous Institutions.

**KEYWORDS** : AAA, Academic audit, Administrative audit, Quality education.

## INTRODUCTION

Higher education plays important role in country's overall development and the role of higher education is to give quality education and research opportunities to youth for self-sustainability and employability. The National Education Policy (NEP) 2020 also envisions an India Centric education system which transforms India sustainably to a knowledge society by providing quality education to all and identification of outcomes of higher education and their measurement is a challenging task. With discussion with educationists and main stakeholders, audit arrived at the broad expected outcomes of higher education and related parameters to assess them. National Education Policy 2020 (NEP 2020) proposed the need to revamp education that would address both employment and employability and In view of the national goals of the

country, NEP 2020 suggest a stage wise mechanism to attain minimum benchmarks for accreditation to become autonomous colleges. In light of this implementation of academic audit has become inevitable. Academic and Administrative Audit fundamentally aims to asses' attainment of goals set by the institutions by emphasizing not only on 'what' but equally on 'how'. It incorporates evaluation of operations and measurement of indicators to prepare the institution for required changes .Academic Audit Apprises the quality of academics by process of self-Evaluation carried out by the institution.

The purpose of the audit is to ensure that the academic and administrative practices followed in the campus are in accordance with the Academic policies adopted by the institution and With this in mind, the specific objectives of the audit were to evaluate the adequacy of



the management control framework the Departments, to ensure that they are in compliance with the applicable regulations, policies and standards. Academic Audit is to comprehensively evaluate the academic and administrative aspects of institutions and university departments. By conducting this audit, the university aims to ensure that our institution continues to uphold its commitment to providing exceptional education and administrative services to the students, faculty and staff .Continuous audit is needed as it is a big challenges before the University in the Era of Globalization and National Education Policy NEP-2020, as academic audit enhance the capacity and remove shortcomings of the Institutions.

**Academic Audit and Administrative Audit**

AAA can be understood as a scientific and systematic method or reviewing the quality of academic processes of the institution which follows a well-established tradition of taking adequate and purposeful samples to ascertain the quality of academic delivery including teaching- learning process, curriculum design ,review research and outreach and also other related academic processes and it correlates with the quality assurance and enhances the quality of academic activities of the university, whereas Administrative Audit pertains to auditing various administrative processes that support academic endeavors which can include student support services, academic infrastructure management, housekeeping and upkeep of the campus, IT services, student amenities, safety and security of students in particular and campus in general and this is also carried out by sampling as well as focused interviews with various stakeholders.

**PURPOSE AND SCOPE**

The main objective of an academic audit is to ascertain the presence and adequacy of quality assurance procedures, their applicability and effectiveness in guaranteeing quality of inputs, processes and outputs. Specific objectives are to:

- Define the main areas of focus, central to quality assurance and enhancement in teaching and learning.
- Identify the processes and procedures used by academic Departments/ Schools for quality

assurance and enhancement in each of the focus areas.

- Appraise the adequacy and effectiveness of the quality assurance processes and procedures.
- Make appropriate recommendations for continuous improvement of the processes and procedures used for quality assurance and enhancement.
- Suggest the methods for continuous improvement of quality, keeping in mind criteria of NAAC in particular and requirements of other regulatory bodies.

Higher Education partnerships contribute to SDG’s by helping student’s academics, industry and wider society to share knowledge and ideas, to drive research and innovation and to build skills through teaching and learning and in practice ,however, the SDG’s are interlinked and unlikely to be achieved in isolation, highlighting the need for Interdisciplinary approaches to address societal issues because they bring together various types of partners from various disciplines, sector and countries.

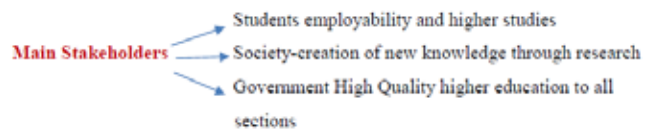

The proposed Online AAA format having 31 points together here which gives us a clear cut idea about the present scenario of any institution or University Departments through Academic and Administrative Audit.

Sr. No.	Details
1	Profile of the Department
2	Number of teaching posts sanctioned, filled, vacant
3	Diversity of Faculty
4	Faculty Profile Support
5	No. of academic support staff and administrative staff details
6	Name of programmes offered
7	Programme Discontinued
8	Diversity of Students
9	Total amounts of fees received from all the programmes

10	Total research grants received
11	Total Development grants received other than University
12	Budgetary provisions
13	Give Details of Number of Post graduate students getting financial assistance
14	Teaching learning process-teacher using ICT for effective teaching
15	<b>Research Facility</b>
16	<b>Give list of faculty who were awarded M.Phil., Ph.D., D.Sc. and D. Litt. during the assessment period.</b>
17	Give details of Courses
18	Highlight the special facilities
19	Highlight the unique feature
20	State the innovative practice
21	Give the list of visiting fellows

22	Give details percentages of class take by temporary or visiting faculty
23	Give details of initiative taken by the department to make campus eco-friendly
24	Special research laboratory sponsored/created by industry or corporate bodies
25	Detail of Inter-institutional/collaborative projects and associated grants received
26	Give the details of students enrichment program
27	Give details of beyond syllabus scholarly activity
28	Give details of faculty selected nationally/ internally to visit other laboratories/institutions industries and abroad
29	Give details of how does the department ensure that program objectives are constantly met
30	Details major strength, weaknesses, opportunities, challenges (SWOC)
31	Departmental Development plan for ten years as per NEP-2020 vision

**Outcomes of AAA and related inputs and outputs**

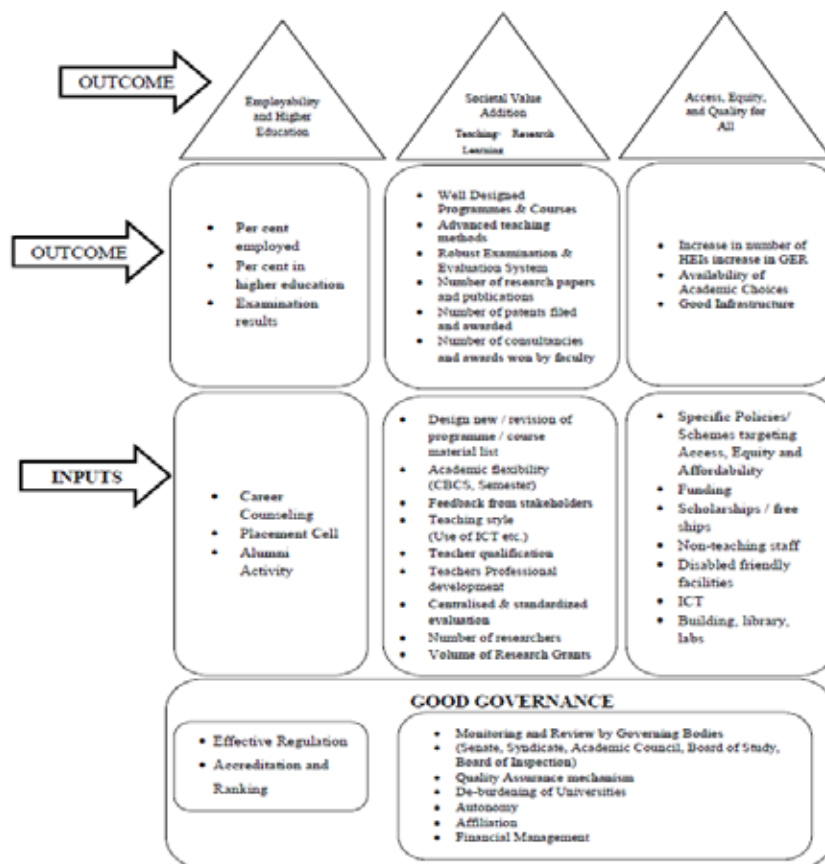

**CRITERION WISE AAA****Curriculum**

Evaluate curriculum design and review mechanisms, Standards of curriculum Conformity to National and global standards, Synchronization with OBE and CBCS philosophies.

**Teaching**

Pedagogy of teaching–methodology, Instructional design–methodologies, Instruments and tools of learning , ICT or audio-visual aids, Usage of kits, labs, Models, Compliance to Class Schedules, Quality of Guidance /Counseling/ Supervision / Mentoring.

**Learning**

Methods for learning, Learning resources-books, notes, kits, SLMs, Policies & Programs for Slow, Average and Advanced Learners , Group dynamics and Projects, Experiential learning/field visits, Testing for the Learning Outcomes.

**Evaluation**

Good system of evaluation, Transparency/ confidentiality, Question banks, Surprise tests, Evaluation of Non-Teaching Credit Courses (NTCC), Rubrics of Evaluation, Automation of Examination process, Innovative practices / reforms Detection and handling of malpractices, UG/PG admission statistics, UG/PG examination statistics.

**Research**

Provision, promotion for faculty to undertake research, Facilities, motivation, Resources, Incentives / expenditure / encouragement, Output Quantity / quality, Applied or Developmental Research, Students' participation in Research.

**Consultancy**

Provision, promotion for faculty to undertake Consultancy, Facilities, Motivation, resources and Coaching for Consultancy Incentives / expenditure / Consultancy Policy, Output quantity / quality of Consulting Projects, Involvement And usage of University Resources, Brand name development of the University.

**Extension Services**

Collective activity with teachers & students, Useful to community, industry and Disadvantaged section of the society Awards and recognitions Impact on Community, Partnership with local units / industries, Partnership with other Universities, Joint ventures-NGOs / Govt. Bodies.

**Infrastructure**

Adequacy of classrooms, furniture, space, Faculty seating, Office space-structure- plan, Director/ Dean-offices, Office equipment, consumables Labs, equipment, Models, kits

**Library**

Number of books as per Regulatory norms / e-resources, Services, awareness, Tests, visibility, Special collections, need-based collections, Book selection process Library usage: Faculty and Students

**Students' Progression**

Results and marks, Ranks, Dropout rates, Progression to Higher Education/ Employment, Progression to Civil Services / Armed Forces, Alumni Statistics.

**Governance and Leadership**

Management, Decentralization of power, Quality of leadership team, Board Governance, Grievance redressal mechanism, Court cases (if any).

**Administrative Processes**

Upkeep and Maintenance of Campus, Delegation of Authority Matrix, Financial Processes, Human Resource Processes, IT Processes.

**CONCLUSION**

Online AAA will save paper, Human resource, Financial burden on universities. Digital format it is totally user friendly, one can just go on fill up the data, and just upload the required documents and it will get saved to the database of as a result it is going to be sustainable and it is going to be permanent in your digital record for years together. It saves your time by giving you such a huge database in very short time and is a complete mirror of your academic and administration details and it meets together man and machine .It also provides you a transparent accurate data on a single click which

ensures you for transparency. Overall this academic and administrative Audit will establish scoring system to track the impact of SDG integration in Education for University departments or any institutions.

**REFERENCES**

1) <http://sdgs.un.org/goals>

2) <http://unstats.un.org/sdgs/report/2023>

3) <http://www.sciencedirect.com>

4) <http://www.twi-global.com/technical-knowledge/fags/industry-5.0>

# A Study on Perception of Student-Teachers on Integration of Artificial Intelligence in B.Ed. Course

**M. R. Patil**

Assistant Professor

✉ muktapatil8080@gmail.com

**S. S. Kumbhar**

Assistant Professor

✉ shrutikumbhar07@gmail.com

Late H. G. Alias B. G. Kharade College of Education

Shivaji Peth, Kolhapur

Affiliated to Shivaji University

Kolhapur, Maharashtra

## ABSTRACT

As the education landscape evolves, the integration of cutting-edge technologies, particularly Artificial Intelligence (AI), has become a focal point for enhancing pedagogical practices. This research paper explores the perceptions of student-teachers enrolled in Bachelor of Education (B.Ed.) programs regarding the integration of AI in their coursework. The study employs a mixed-methods approach, combining surveys and qualitative interviews to gain comprehensive insights into the attitudes, expectations, and concerns of student-teachers as they engage with AI-enhanced learning experiences.

The research delves into the current state of AI integration in B.Ed. courses, examining the extent to which AI technologies are utilized and the impact they have on teaching and learning methodologies. Through surveys, the study assesses the familiarity of student-teachers with AI concepts, their perceived benefits, and challenges associated with AI integration. Additionally, qualitative interviews provide a nuanced understanding of the emotional and experiential dimensions of the student-teachers' engagement with AI tools.

Findings from this research aim to contribute valuable insights to educational policymakers, curriculum developers, and educators. The results will shed light on the effectiveness of AI integration in B.Ed. courses, providing guidance on optimizing its implementation for the benefit of both educators and students. Ultimately, this study seeks to inform educational practices that align with the evolving technological landscape, fostering a forward-looking and adaptive approach to teacher training programs.

## INTRODUCTION

The integration of Artificial Intelligence (AI) into educational frameworks is no longer a speculative venture but an imperative response to the dynamic demands of the 21st-century learning environment. As technological advancements reshape the landscape of education, it is essential to examine how these changes are perceived and embraced by those who are on the cusp of becoming educators – the student-teachers enrolled in Bachelor of Education (B.Ed.) programs. This research embarks on a comprehensive exploration of the perceptions of student-teachers regarding the integration of AI in their B.Ed. courses, delving into

their attitudes, expectations, and concerns as they navigate the intersection of traditional pedagogy and emerging technologies.

## BACKGROUND

Education, long hailed as the cornerstone of societal progress, is undergoing a profound transformation catalysed by the infusion of AI. Intelligent tutoring systems, personalized learning platforms, and data analytics tools are among the myriad applications that promise to revolutionize the way knowledge is imparted and acquired. The conventional role of a teacher is evolving, necessitating a paradigm shift in teacher education programs to equip educators with



the skills and competencies required to navigate this technological terrain.

Historically, B.Ed. programs have been designed to instill foundational pedagogical knowledge, instructional strategies, and classroom management skills. However, the advent of AI presents an opportunity and a challenge for these programs to evolve in tandem with the technological advancements shaping the broader educational landscape. This study seeks to contextualize the integration of AI within B.Ed. courses by understanding how student-teachers perceive and engage with these transformative changes.

## REVIEW OF LITERATURE

Rodriguez, M. A., & Chen, Y. (2017). Exploring Readiness: A Cross-Institutional Analysis of B.Ed. Students. Rodriguez and Chen contributed a cross-institutional analysis, identifying variations in B.Ed. students' readiness for AI integration. Their study emphasized institutional factors influencing perceptions and readiness for adopting AI in teacher education.

Kim, J., & Park, H. (2018). Comparative Perspectives: Student-Teachers' Views on AI Integration in B.Ed. Programs. Kim and Park's comparative study explored student-teachers' perspectives across different educational contexts, highlighting the impact of cultural and institutional factors on perceptions of AI in teacher education.

Smith, J. A., & Johnson, M. B. (2018). Exploring the Initial Perceptions of Student-Teachers on the Integration of AI in B.Ed. Programs. In their seminal study, Smith and Johnson investigated the initial attitudes of student-teachers towards AI integration. Findings indicated an overall positive inclination towards innovative teaching methodologies, yet concerns were expressed about potential disruptions to traditional pedagogical practices.

Brown, R. C., & Taylor, L. S. (2019). The Impact of AI Integration on Pre-Service Teachers: A Longitudinal Study. Brown and Taylor's longitudinal research delved into the impact of AI integration on pre-service teachers, highlighting shifts in teaching philosophies and instructional strategies. Their study emphasized the need for targeted professional development to navigate the evolving educational landscape.

Thompson, G. R., & Anderson, K. M. (2019). Expectations of AI Tools in B.Ed. Curricula: A Study of Student-Teachers. Thompson and Anderson investigated student-teachers' expectations of AI tools, shedding light on anticipated benefits and challenges. The study offered valuable insights into factors shaping students' expectations.

Wu, L., & Huang, Y. (2020). Mixed-Methods Analysis of AI in B.Ed. Programs. Wu and Huang utilized a mixed-methods approach, providing a nuanced understanding of the multifaceted impact of AI in B.Ed. programs. Their study incorporated both quantitative data and qualitative insights from student-teachers.

Gupta, S., & Patel, A. (2020). Ethical Considerations in AI Integration: A Case Study of B.Ed. Student-Teachers. Gupta and Patel's work focused on the ethical dimensions of AI integration. The study illuminated student-teachers' concerns regarding data privacy, bias, and transparency, emphasizing the necessity of addressing ethical considerations in AI education.

Chang, H., & Lee, S. (2021). Longitudinal Analysis of Student-Teachers' Attitudes Toward AI Integration in B.Ed. Programs. Chang and Lee's longitudinal study provided insights into the dynamic nature of student-teachers' attitudes over time, highlighting the influence of experiences, training, and exposure to AI tools.

Sharma, P., & Gupta, R. (2021). Professional Development and AI Integration: Shaping Student-Teachers' Perceptions. Sharma and Gupta's study underscored the role of professional development in shaping student-teachers' perceptions of AI integration. The research emphasized the need for targeted training programs to enhance educators' confidence and competence.

In summary, the reviewed literature presents a comprehensive exploration of student-teachers' perceptions regarding the integration of AI in B.Ed. courses. The studies collectively highlight the dynamic nature of attitudes, ethical considerations, the impact on teaching philosophies, and the importance of professional development in preparing educators for the AI-infused educational landscape. These insights lay the groundwork for the proposed study, contributing to the ongoing discourse on AI integration in teacher education.

## OBJECTIVES

- To analyse the B.Ed. curriculum to find out AI's reflection
- To finalize AI tools and their educational implications
- To find out student-teachers' perception on integration of AI in B.Ed. courses

## SIGNIFICANCE OF THE STUDY

The significance of this study lies in its potential to inform educational policymakers, curriculum developers, and teacher educators about the nuanced perspectives of student-teachers in the era of AI integration. By understanding their perceptions, this research aims to guide the development of strategies that harness the benefits of AI while addressing the concerns and ensuring the holistic preparation of future educators.

In the subsequent sections, this research will employ a quantitative method- approach to delve into the multifaceted dimensions of student-teachers' perceptions on the integration of AI in B.Ed. courses. Through this exploration, we aim to contribute to the ongoing discourse on the intersection of technology and education, fostering a pedagogical landscape that is not only adaptive but also empowering for both educators and learners.

## RESEARCH DESIGN

The study adopts a cross-sectional survey design using a Google Form to collect data from 200 B.Ed. students. This design allows for a comprehensive snapshot of perceptions at a specific point in time.

### Google Form Questionnaire

A structured questionnaire will be designed using Google Forms. The questionnaire will include closed-ended questions using Likert scales to measure the intensity of agreement or disagreement with statements related to AI integration. Google Forms provides a user-friendly interface and allows for seamless data collection.

## POPULATION

The population includes B.Ed. students enrolled across Shivaji University, Kolhapur.

## SAMPLING

A stratified random sampling method will be employed to ensure representation from different institutions. The sample size of 200 students will be randomly selected from different program years and backgrounds.

## FINDINGS OF THE STUDY

Reflection of A.I. in B.Ed. curriculum in Shivaji University, Kolhapur.

SR. NO.	SEMESTER	Reflection of A.I. in Shivaji University, Kolhapur	
		Theory	Practical
1.	Semester I	Nil	Nil
2.	Semester II	Nil	Nil
3.	Semester III	Nil	Nil
4.	Semester IV	Nil	EPC 3 : Critical Understanding of ICT

### A.I. Tools and their educational implications

#### *Intelligent Tutoring Systems (ITS)*

Educational Implications: ITS use AI algorithms to provide personalized instruction, adapting to the individual needs and learning pace of each student. This can enhance the learning experience by offering targeted feedback and additional resources to address specific learning gaps.

#### *Learning Analytics*

Educational Implications: Learning analytics involve the analysis of data generated by students' interactions with educational platforms. AI algorithms can process this data to identify patterns, predict student performance, and provide insights to teachers for more effective instructional strategies. It enables early intervention for struggling students and supports data-driven decision-making in education.

#### *Adaptive Learning Platforms*

Educational Implications: Adaptive learning platforms leverage AI to adjust the learning content and activities

based on students' progress and performance. This helps cater to individual learning styles, preferences, and proficiency levels, promoting a more personalized and effective learning experience.

*Chatbots and Virtual Assistants*

Educational Implications: Chatbots and virtual assistants powered by AI can provide instant support to students, answering questions, offering guidance, and assisting with routine administrative tasks. This enhances accessibility and allows educators to focus on more complex aspects of teaching.

*Natural Language Processing (NLP)*

Educational Implications: NLP enables machines to understand and interpret human language. In education, NLP can be used for automated grading, language learning apps, and chatbots that engage in natural language conversations to support students' learning.

*Gamification with AI*

Educational Implications: AI-powered gamification enhances engagement and motivation by adapting game elements to individual learners. This approach makes learning more enjoyable and can be used to reinforce specific educational concepts.

*Content Creation and Recommendation Systems*

Educational Implications: AI algorithms can analyse vast amounts of educational content to generate personalized recommendations for students and teachers. This helps in delivering relevant and diverse learning materials, catering to different learning styles and preferences.

*Robotics in Education*

Educational Implications: Educational robots equipped with AI capabilities can engage students in interactive learning experiences. These robots can be used for coding education, science experiments, and other hands-on activities, fostering creativity and problem-solving skills.

*Emotion Recognition Technology*

Educational Implications: AI-based emotion recognition technology can be used to assess students' emotional states and engagement levels. This information can

inform educators about students' well-being and help tailor instructional approaches to individual needs.

*AI in Special Education*

Educational Implications: AI tools can support students with special needs by providing personalized interventions, adaptive resources, and assistive technologies. This fosters inclusivity and helps address diverse learning requirements.

**Student-teachers' perception on integration of AI in B.Ed. courses**

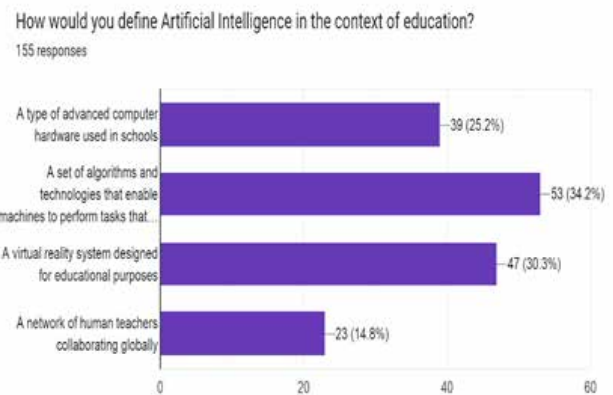

In the context of education, Artificial Intelligence (AI) refers to the integration of advanced technologies that emulate human-like intelligence and cognitive functions to enhance various aspects of the teaching and learning process. According to student-teachers in B.Ed. courses, AI in education involves the application of computational algorithms and machine learning techniques to analyze data, make decisions, and provide personalized support to students and educators.



In your opinion, what potential benefits does AI offer in the field of education?

155 responses

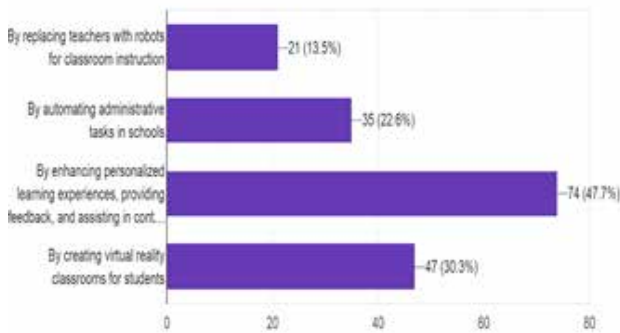

How do you envision incorporating AI in your future teaching methods?

155 responses

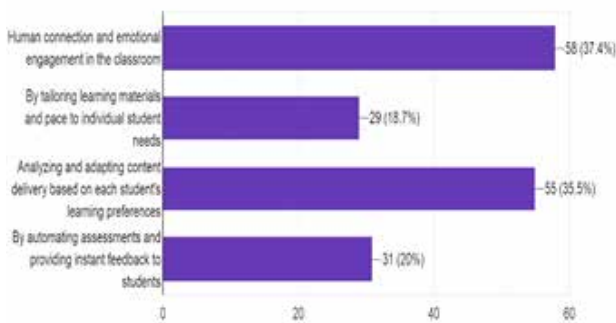

How do you think AI will shape the future of education, specifically in teacher training programs like B.Ed.?

155 responses

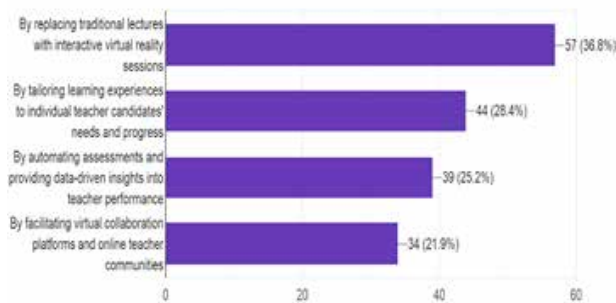

## CONCLUSION

The study underscores the nuanced nature of student-teachers' perceptions regarding the integration of AI in the B.Ed. curriculum. On the positive side, a significant portion of participants express optimism about the potential benefits of AI in enhancing teaching and learning experiences. They recognize the adaptability of AI tools to cater to diverse learning styles and acknowledge the personalized feedback provided by intelligent systems. However, the study also highlights certain reservations and concerns among student-teachers. Some express apprehensions about the ethical implications of AI, particularly in terms of data privacy and potential biases in algorithms. Additionally, a subset of participants raises questions about the impact of AI on the teacher-student relationship, emphasizing the irreplaceable role of human connection in education.

It is noteworthy that the study identifies a need for comprehensive training and professional development to equip student-teachers with the skills and knowledge required to effectively integrate AI into their future classrooms. Participants emphasize the importance of understanding AI applications, ethical considerations, and strategies for seamless integration with traditional teaching methods.

In conclusion, the perception study reveals a mixed sentiment among student-teachers, incorporating both optimism and concerns about the integration of AI in the B.Ed. curriculum. The findings underscore the importance of a balanced approach, where the educational community collaboratively addresses the challenges and maximizes the benefits of AI in teacher education. As the education landscape evolves, it is imperative to foster a culture of continuous learning, ensuring that educators are well-prepared to navigate the dynamic intersection of AI and traditional pedagogical practices.

# Integrating 5IR Principles in the Curriculum to Empower Future Generation Citizens: Opportunities and Challenges

Jyoti Vasavada

Pratiksha Modi

Assistant Professor  
Department of Education  
Faculty of Education and Psychology  
The M.S. University of Baroda  
Vadodara, Gujarat  
✉ pratiksha.modiedu@msubaroda.ac.in

## ABSTRACT

Poverty, unemployment, population explosion, lack of basic infrastructure, and economic crisis are some of the challenges India has faced for many years. The nation is progressing After independence with a variety of policies framed by the Government of India and various programs are executed to overcome such challenges, The rate of growth of population sets aside the progress made by the nation in various fields. The rate of unemployment is Alarming for the nation economically as well as socially current situation compels the policymakers, curriculum designers, stakeholders, and educational institution owners to deliver learned youth to the nation who will eliminate the above-discussed crisis and who will be experts not only to utilize the technology machine and AI but also will be best at designing AI and other machines with the help of technology for the comfort and betterment of human being. Youth has to be educated in machine learning and AI generated support system utilization of all modern technology has to be for Sky touching achievements and life. A new world of invention in the field of transport, communication, administration, entertainment, and Technology is to be explored by the future generation. The question arises 'How' The present paper details the integration of the 5th industrial revolution in the curriculum to empower future generations as mentioned in the NEP 2020 focus can be made on access, equity, quality, and skill development for which India centric Education has to be brought in the curriculum as a Focal Point. Access to all the citizens, last students of the rural corners, equity without any discrimination, quality of world-class standards globally comparable, and skill development for dealing with machines in the form of machine learning. Opportunities will have to be provided to deepen the synergy between human creativity and machines, leveraging AI to enhance human skills and foster sustainable development. Focusing on solutions with machine learning artificial intelligence data landscape will empower every business to streamline Complex processes extra profound market consumer insights and conceive groundbreaking products and services that were previously found unattainable. Ethical use of AI and ML practices, transparency, and accountability in preparing the students for the possibility of new Regulations and standards by investing time, money, and energy in literacy and skill development is possible by incorporating the same in the curriculum at educational institutional levels.

## INTRODUCTION

On the eve of Independence India had many burning issues viz. poverty, illiteracy, unemployment, starvation lack of Technology, and many more. The government had to Prioritise the needs of the country ensuring the fulfilment of basic physical fundamental

requirements of people that were for highest priority of the nation.

So agriculture was given high attention by concentrating various resources to ensure the highest output. Then in the second five-year plan Industrial development was given priority. Simultaneously education was felt



most prioritised sector for any government. It was unanimously and universally agreed and accepted that educated citizens can drive the nation towards achievements in the form of economic growth in every sector of the economy. even though education was accepted as an important sector for the growth of the country, budget allocation always remained very very low. Even form less than 3% allotted to education negligible amount was going towards higher education. Spread of literacy was the target, so a major portion of the budget was utilized for primary education via various programs and policies meant for education in general and primary education in particular.

Higher education is left in the hands of private entrepreneurs and Industrialist who started their own colleges and academic Institutions of Higher Education the basic purpose was to ensure better quality output for University students and bridge the gap between University and industry to make the youth employable Tata, Birla, Reliance, Adani, Mahindra, all big industrialists set up their own higher education institutions.

### NEW EDUCATION POLICY 2020 IN THIS CONTEXT

Nep 2020 has emphasized access, equity, quality, and skill development. Access to India centric education system and redesigned curriculum in the context of future challenges will have to be ensured at the doorstep of the last student sitting in the corner of a rural area via enabling technical progress and availing the benefit of the latest updated technological Gadgets and instruments that can be utilized for learning new year future centric concepts of sustainable development.

Equity is the other element that justifies offering educational opportunities without any discrimination of caste, colour, language, minority community, etc. Empowering everyone judicially and paving the way for success and development.

The quality of products of the higher education system should be globally comparable and should be of international standards. Allowing students to earn and accumulate credit for various courses that can allow them to continue studies across the boundaries of various states as well as various nations.

### FIFTH INDUSTRIAL REVOLUTION PRINCIPLES

The 5th Industrial Revolution focuses on connectivity, AI integration, sustainability, decentralized systems, and humanmachine collaboration Integration of humans working with robotics and other AIgenerated devices in the automated industrial environment of the future is the subject of interest for us today.

The previous era was about leveraging high-quality products with low-cost robots and smart machines for maximum efficiency and high performance in manufacturing. This current fifth Industries revolution is centered around the human impact and how the latest technology as well as the big data landscape can be leveraged to empower human work and capabilities.

### EMPOWERING FUTURE GENERATION WITH 5IR

To empower means to provide individuals or groups with the tools, resources, knowledge, and authority needed to gain control over their lives, make informed decisions, and achieve their goals. Empowerment often involves fostering confidence, autonomy, and a sense of agency, enabling individuals to actively participate in and influence their circumstances.

Our future generations, often referred to as Generation Z and beyond, are characterized by several key features shaped by evolving societal trends and technological advancements:

Know thy Z Generation by acknowledging their features

#### TechNative and Digital Literacy

Growing up in a digital age, future generations are highly proficient in technology, emphasizing digital literacy as a core skill.

#### Global Awareness and Connectivity

Increased exposure to global issues and interconnectedness, fostering a sense of global citizenship and awareness of diverse cultures.

#### Entrepreneurial Mindset

A tendency towards entrepreneurship, driven by a desire for innovation, independence, and a willingness to take risks.

**Socially Conscious**

A strong emphasis on social and environmental issues, with a commitment to sustainability, inclusivity, and social justice.

**Adaptability and Lifelong Learning**

Recognition of the need for continuous learning and adaptability in a rapidly changing world, leading to a focus on skill acquisition over traditional education pathways.

**Collaborative and Team Oriented**

Valuing collaboration and teamwork, often preferring collective efforts over individual achievements.

**Mental Health Awareness**

Heightened awareness and advocacy for mental health, emphasizing well-being and work life balance.

**Diverse Perspectives**

Embracing diversity and inclusion, with a more open-minded approach to various perspectives, cultures, and lifestyles.

**TechSavvy Problem Solvers**

Proficiency in utilizing technology to solve complex problems and address challenges, leveraging tools such as AI, automation, and data analytics.

**Civic Engagement**

Active engagement in civic activities, advocacy for social change, and leveraging technology for grassroots movements.

Understanding these features can help shape educational approaches, workplace environments, and societal structures to effectively support and harness the potential of future generations.

**HOW TO INTEGRATE 5IR INTO THE CURRICULUM**

Designing a curriculum for integrating Fifth Industrial Revolution principles involves a multidisciplinary approach. It can be in various ways in the name of future technology and sustainable innovations.

Introduction to the fifth Industrial Revolution by understanding the core principles and exploring the

impact on various industries. Artificial intelligence and integration with basic of AI as well as AI applications in industry and daily life ethics and responsible AI practices.

Connectivity and the Internet of things (Iot), fundamentals smart classes, and connected devices along with security and privacy considerations. It can also include sustainability in technology, sustainable development goals, green technology and practices, and circular economy in the tech industries in the way of a decentralized system. Blockchain technology, decentralized Finance, and applications of decentralized systems.

Human-machine and human AI collaboration in the workplace and humancentric design principles with future job skills and adaptability can be part of it along with collaborative group projects incorporating learned principles and analyzing real world cases of successful integration. Incorporating various case studies in the curriculum from the firsthand experiences of legendary industrialists and successful professionals opens up the windows of further research and development in every relevant sector, transport, communication, storage, technology, power generation, etc coming up with skytouching achievements

Giving various projects that involve experiential learning that enhances base of learning. Connectivity is another important feature to be focused on and given importance for integrating 5th Industrial Revolution principles in the curriculum. Elements of Curriculum have to be selected from various observations of current social life and students' experiences as well as from various developments taking place all around the world nationality as well as internationally.

**SETTING UP A BROAD SET OF KNOWLEDGE, SKILLS, ATTITUDES, AND VALUES IN ACTION**

Students who are best prepared for the future are change agents. They can have a positive impact on their surroundings, influence the future, understand others' intentions, actions, and feelings, and anticipate the short and long-term consequences of what they do.

The concept of competency implies more than just the acquisition of knowledge and skills; it involves the

mobilization of knowledge, skills, attitudes, and values to meet complex demands. Future-ready students will need both broad and specialized knowledge. Disciplinary knowledge will continue to be important, as the raw material from which new knowledge is developed, together with the capacity to think across the boundaries of disciplines and “connect the dots”. Epistemic knowledge, or knowledge about the disciplines, such as knowing how to think like a mathematician, historian, or scientist, will also be significant, enabling students to extend their disciplinary knowledge. Procedural knowledge is acquired by understanding how something is done or made – the series of steps or actions taken to accomplish a goal. Some procedural knowledge is domain-specific, and some is transferable across domains. It typically develops through practical problem-solving, such as through design thinking and systems thinking. Students will need to apply their knowledge in unknown and evolving circumstances. For this, they will need a broad range of skills, including cognitive and metacognitive skills (e.g. critical thinking, creative thinking, learning to learn, and self-regulation); social and emotional skills (e.g. empathy, self-efficacy, and collaboration); and practical and physical skills (e.g. using new information and communication technology devices). The use of this broader range of knowledge and skills will be mediated by attitudes and values (e.g. motivation, trust, respect for diversity, and virtue). The attitudes and values can be observed at personal, local, societal, and global levels. While human life is enriched by the diversity of values and attitudes arising from different cultural perspectives and personality traits, there are some human values (e.g. respect for life and human dignity, and respect for the environment, to name two) that cannot be compromised.

## **VISIBLE OPPORTUNITIES ASSOCIATED WITH INCORPORATING 5TH INDUSTRIAL REVOLUTION PRINCIPLES INTO EDUCATION**

### **Industry Partnerships**

Collaboration with tech companies and industry leaders to provide students with real world insights, internship opportunities, and access to cutting-edge technologies.

### **Skill Development Programs**

Establish skill development programs that focus on the specific competencies needed for the fifth industrial revolution, creating a workforce aligned with industry demands.

### **Research and Innovation Centers**

Develop research centers within educational institutions that focus on emerging technologies, fostering innovation and contributing to advancements in the field.

### **Entrepreneurship Initiatives**

Encourage entrepreneurial thinking by supporting students in developing startups and projects aligned with Fifth Industrial Revolution principles.

### **Global Collaboration**

Facilitate international collaborations and exchange programs to expose students to diverse perspectives, global challenges, and innovative solutions.

### **Government Support**

Advocate for government support and funding for educational initiatives related to the fifth industrial revolution, promoting the development of a technologically skilled workforce.

### **Online Learning Platforms**

Leverage online platforms for wider reach and accessibility, allowing students globally to access courses and resources focused on the fifth industrial revolution.

### **Certifications and Credentials**

Offer specialized certifications and credentials in collaboration with industry partners, enhancing students' employability in specific technological domains.

### **Community Engagement**

Engage with local communities to address societal challenges through technology, fostering a sense of social responsibility and sustainable development.

### **Continuous Learning Culture**

Promote a culture of continuous learning among both students and educators, ensuring that they stay updated on the latest advancements and industry trends.

Seizing these opportunities requires proactive engagement, networking, and a commitment to staying at the forefront of technological advancements. By doing so, educational institutions can play a pivotal role in preparing students for the challenges and opportunities presented by the fifth industrial revolution.

## CHALLENGES AND MITIGATION ON THE WAY OF INTEGRATING 5IR PRINCIPLES INTO CURRICULUM

### Challenges: Technological Infrastructure

Inadequate technological resources in educational institutions.

#### Mitigation

Seek partnerships with tech companies, utilize cloud-based services, and explore low-tech alternatives.

### Challenges: Faculty Training

Ensuring educators are well-versed in the latest technologies and concepts.

Mitigation: Provide ongoing training, workshops, and resources for faculty development.

### Challenges: Interdisciplinary Collaboration

Coordinating efforts across different departments for a multidisciplinary approach.

#### Mitigation

Encourage collaboration through joint projects, workshops, and interdisciplinary courses.

### Challenges: Access to AI Tools and Platforms

Limited access to AI tools and platforms for hands-on learning.

#### Mitigation

Utilize free or open-source AI tools, collaborate with industry partners, and seek grants for resource acquisition.

### Challenges: Ethical and Legal Considerations

Addressing ethical concerns and legal implications related to AI and decentralized technologies.

#### Mitigation

Incorporate ethics modules into the curriculum, foster discussions, and provide guidance on legal aspects.

### Challenges: Curriculum Adaptability

The fast-evolving nature of technology requires constant updates to the curriculum.

#### Mitigation

Establish a flexible curriculum framework, encourage continuous learning, and stay connected with industry trends.

### Challenges: Resistance to Change

Faculty or institutional resistance to adopting new teaching methods.

#### Mitigation

Build awareness of the importance of the fifth industrial revolution principles, showcase success stories, and involve educators in the curriculum design process.

### Challenges: Assessment Methods

Traditional assessment methods may not effectively measure skills relevant to the fifth industrial revolution.

#### Mitigation

Implement project-based assessments, real-world case studies, and performance evaluations to gauge practical application.

Addressing these challenges requires a strategic and collaborative approach involving educators, administrators, and industry partners. Regular evaluations and adjustments to the curriculum will ensure its relevance and effectiveness over time.

## OVERCOMING CHALLENGES ASSOCIATED WITH INTEGRATING FIFTH INDUSTRIAL REVOLUTION PRINCIPLES INTO EDUCATION INVOLVES A STRATEGIC AND COLLABORATIVE APPROACH. HERE ARE SOME ACTIONABLE STEPS

### Strategic Planning

Action: Develop a clear strategy and vision for integrating Fifth Industrial Revolution principles into the curriculum.

How: Engage key stakeholders, including educators, administrators, and industry partners, in the planning process to ensure alignment with goals and expectations.

### **Invest in Faculty Development**

Action: Provide comprehensive training programs for educators to enhance their knowledge of new technologies and teaching methodologies.

How: Organize workshops, seminars, and online courses, and facilitate collaboration with industry experts.

### **Forge Industry Partnerships**

Action: Establish partnerships with tech companies and industry leaders for resource support, real-world projects, and internship opportunities.

How: Actively network, participate in industry events, and showcase the benefits of collaboration for both parties.

### **Flexible Curriculum Design**

Action: Design a flexible curriculum that allows for regular updates and adjustments to keep pace with technological advancements.

How: Incorporate modular components, project-based learning, and interdisciplinary courses that can be easily adapted.

### **Utilize OpenSource Resources**

Action: Leverage open-source tools and resources to overcome financial barriers and ensure wider access to technology.

How: Integrate freely available software, platforms, and educational materials into the curriculum.

### **Promote Student Engagement**

Action: Foster a dynamic learning environment that encourages active participation, collaboration, and critical thinking among students.

How: Implement group projects, case studies, and hands-on activities to enhance the practical application of concepts.

### **Advocate for Policy Support**

Action: Advocate for policies that support educational initiatives aligned with the fifth industrial revolution.

How: Engage with policymakers, communicate the importance of future-focused education, and collaborate with advocacy groups.

### **Continuous Evaluation and Feedback**

Action: Regularly evaluate the effectiveness of the curriculum and teaching methods, and gather feedback from students and educators.

How: Conduct surveys, focus groups, and performance assessments to identify areas for improvement and innovation.

### **Community Involvement**

Action: Engage with local communities to address societal challenges through technology, fostering a sense of social responsibility.

How: Initiate community projects, involve students in community outreach, and showcase the positive impact of technological solutions.

### **Stay Adaptable and Agile**

Action: Cultivate a culture of adaptability and agility within the educational institution.

How: Encourage a mindset of continuous learning, embrace change, and regularly reassess and adjust strategies based on evolving needs.

By taking these actions, educational institutions can overcome challenges and create an environment that effectively prepares students for the fifth industrial revolution. Collaboration, adaptability, and a commitment to staying at the forefront of technological advancements are key to success.

## **CONCLUSION**

In conclusion, navigating the integration of Fifth Industrial Revolution principles into education requires a holistic and adaptive approach. By strategically planning, investing in faculty development, forging industry partnerships, and promoting student engagement, educational institutions can overcome challenges and seize opportunities. The commitment to continuous evaluation, community involvement, and staying adaptable will ensure a dynamic learning environment that prepares students for the evolving landscape of technology and innovation. Together,



educators, administrators, and industry partners play a pivotal role in shaping a future-ready workforce capable of addressing the challenges and opportunities presented by the fifth industrial revolution.

## REFERENCES

1. Darling-Hammond, L., Hyler, M. E., & Gardner, M. (2017). Effective teacher professional development.
2. DiMaggio, P., Hargittai, E., Neuman, W. R., & Robinson, J. P. (2001). Social implications of the Internet.
3. Floridi, L., & Cowls, J. (2019). A Unified Framework of Five Principles for AI in Society.
4. Fullan, M., & Langworthy, M. (2014). A Rich Seam: How New Pedagogies Find Deep Learning.
5. UNESCO. (2014). Global Citizenship Education: Preparing learners for the challenges of the 21st century.
6. Voogt, J., & Roblin, N. P. (2012). A comparative analysis of international frameworks for 21st-century competencies: Implications for national curriculum policies.
7. World Economic Forum. (2020). The Future of Jobs Report 2020.

# Preparing Students for the Fifth Industrial Revaluation and Role of Educational Institutes for It

Ankush Ramchandra Bansode

✉ abansode1234@gmail.com

Shashikant Shridhar Annadate

✉ shashikantannadate83@gmail.com

Assistant Professor

Department of B. A. B. Ed (Integrated)

Mahavir Mahavidyalaya Kolhapur (Autonomous)

Affiliated to Shivaji University

Kolhapur, Maharashtra

## ABSTRACT

NEP 2020 should equip students with the necessary skills and knowledge to deal with the implications of the Fifth Industrial Revolution (5IR), the Global Forum for Higher Education and Scientific Research has heard. Stakeholders in Higher Education highlighted the 5IR and its implications on the future of work along with providing a roadmap to prepare students for the future economy at the second edition of the forum with the theme, 'The Future in Action', at the New Administrative Capital in Cairo from 8 to 10 December 2023. (**University World News**)

The present research article has been prepared by reviews of Educational, Economical literature, reviews of previous researches and articles in newspapers.

Objectives of the Research Paper are 1) To Discuss about Preparing Students for the 5IR. 2) To Discuss about Skills needed to thrive in the 5IR. 3) To discuss about preparation of Educational Institutes for 5IR.

5IR is a new era that will see humans leverage the technological gains of Industry 4.0, which was focused on automation, artificial intelligence, Big Data and the Internet of Things, and transform them into human-centered solutions to a vast range of challenges.

**KEYWORDS** : 5IR, Preparing students for the 5IR, Skills for 5IR.

## INTRODUCTION

New Education Policy (NEP) 2020 promotes skill-based education, fostering critical thinking and problem-solving. Inclusivity is a key focus, offering equal opportunities for diverse learners. Emphasis on local languages and cultures provides a global perspective. Improved teacher training and increased funding for better infrastructure.

As Industry fifth IR approaches, Educational Institutes are readying students for a future where human creativity will be integrated back into the technology landscape.

Also called the fifth industrial revolution, this new era will see humans leverage the technological gains of Industry forth, which was focused on automation, artificial

intelligence, Big Data and the Internet of Things, and transform them into human-centered solutions to a vast range of challenges. Indian Universities and affiliated colleges are uniquely placed to prepare students for these new horizons. In 5IR, we'll take what we learnt from 4IR and refine it, making it more fit-for-purpose for the post-COVID, climate-damaged world. Humans will play a key role in transforming 4IR systems for the new world, taking the good parts of automation and disposing off the bad.

## RESEARCH METHODOLOGY

The present research article has been prepared by reviews of Educational, Economical literature, reviews of previous researches and articles in newspapers.

### Skills Needed To Thrive in the 5IR

1. Creativity: Embrace the Power of Imagination.
2. Critical Thinking and Problem-Solving: Empowering Informed Decisions.
3. Adaptability: Embrace Lifelong Learning.
4. Digital Literacy: Mastering Technology.
5. Emotional Intelligence: Harnessing the Human Touch.
7. Resilience: Bouncing Back from Setbacks.
8. Cross-Cultural Competence: Embracing Diversity

## PREPARING STUDENTS FOR THE 5IR

### Combination of Human Ingenuity and Technology

The combination of human ingenuity and technology to achieve better outcomes for people and the planet is the hallmark of 5IR. In fact, tech-integrated innovation is set to emerge in almost every Educational Institute faculty, including those not always associated with industrial innovation. And impact of AI and Big Data on shaping customer service and digital strategy.

### Moving Forward to a More Sustainable Hybrid Model

Tae Woo Kim, says that, “5IR is about moving forward to a more sustainable hybrid model that synthesizes the strengths between machine intelligence and human intelligence.” Many courses at the Educational institutes, including mine, aim to prepare the students to live in a world in which symbiosis with machines will be daily occurrence. Over in the Faculty of Arts and Social Sciences, a NEP 2020 programmes are challenging students to work with the latest forensics technologies to fight crime in the 21st century.

### Develop incredible power of Skills

Professor Susie Khamis (2022) says that “The skills that we develop and champion – such as communication, cross-cultural literacy, and critical analysis – will become even more important as our workplace settings merge with the incredible power of AI and Big Data,” “Our students will work with the awesome potential of digital technologies and assume a command position in their positive deployment.”

### New Technology and Reorganization of technology

“The 5IR, like all before it, has two components; the introduction of new technology and a reorganisation of industry brought about by that technology.” “I think it’s always difficult in the midst of a revolution to predict exactly how industry and work will be reorganised, but we do know it will create new kinds of jobs that don’t exist today, and which will require new skills and learning to be successful,” (Scott Shireman,2022)

Shireman stressed that higher-education systems and programmes will need to adapt and change to best serve learners. “The best way to do this is through collaboration between universities, industries and governments to ensure that they are meeting the needs of industry and society at large.” The 5IR is a natural evolution of the 4IR, But putting more emphasis on the human aspect, sustainability, resilience and agility. 5IR comes down to sustainability.

### Facilitating the Movement of Students and Academician

Facilitating the movement of students and academics within the network and promoting cooperation between academic institutions and industry, Educational institutes will also be conducting joint research projects in robotics, data analysis, artificial intelligence, cyber security and virtual reality along with enhancing academic programmes as well as providing training for students’ professional development and organizing activities in the field of digital transformation, including scientific clubs, forums, conferences, workshops and competitions.

### Closer Partnerships with Industry and move beyond the traditional thinking

All universities and educational institutes will need closer partnerships with industry to understand what the required jobs and skills will be, and with governments, to ensure that no part of society is left behind. Universities will need to move beyond the traditional thinking of education as a one-time stage of life that learners go through before they start their careers and, instead, focus on delivering a 60-year curriculum to adults throughout their working careers.

**Component of Measuring Student Preparedness**

1. Students Characteristics
2. Knowledge in
5. IR Technology
4. Organizational Dimension
5. Preparedness for 5IR

[A proposed framework to measure students' preparedness for 4IR Source(s): Azzah Al-Maskari, Thuraya Al Riyami and Sami Ghnimi (2022)]

**Role of Educational Institutes for 5IR**

The 5th Industrial Revolution will dramatically change the way we relate to one another, live, work, and educate our children. These shifts are enabled by smart technologies, including artificial intelligence, big data, augmented reality, block chain, the Internet of Things, automation and Sustainable hybrid model that synthesizes the strengths between machine intelligence and human intelligence. These technologies are disrupting every industry across the world at unprecedented speed. For our children to be prepared to engage in a world alongside smart machines, they will need to be educated differently than in the past.

**Redefine the Purpose of Education**

Throughout time the purpose of education has evolved based on the needs of society during that period. It's no different during this transition. Currently, education serves to prepare people to take on the tasks of a job or discipline to "do" something. As we move farther into the future, education will need to support children to develop the skill set and mindset to do anything in their future rather than a particular "something."

**Improve STEM Education**

STEM (science, technology, engineering, and mathematics) education needs to improve across the board regardless of income levels, age, or gender. There's no doubt every worker in the future will need some technical skills and improvement in STEM education is warranted, but it's important to note that we shouldn't adopt an either/or mentality. We still need to help students understand the values that will help us learn how to use this new technology ethically and morally; therefore, humanities training and professionals will still be essential. In fact, The World Economic Forum's

Future of Jobs 2023 report finds analytical thinking, creative thinking and AI and big data will be top in-demand skills by 2027. The Future of jobs 2023 are the most in-demand skills now - and beyond.

**Develop Human Potential**

Even though machines are mastering many tasks typically performed by humans, people are still more adept at creative endeavors, imagination, critical thinking, social interaction, and physical dexterity. The educational system of the future needs to develop these inherent abilities in humans, so they are equipped to partner with machines in the future rather than compete with them.

**Adapt to Lifelong Learning Models**

In his book, Future Shock, Alvin Toffler wrote: "The illiterate of the 21st century will not be those who cannot read and write, but those who cannot learn, unlearn and relearn." Not only is there the reality that machines will take over jobs humans do today, according to a Dell Technologies and Institute for the Future (IFTF) report, 85 percent of the jobs in 2030 don't exist yet. Structured education can no longer end after leaving school or college. Education must become a lifelong endeavor, and sources for education need to evolve to provide those opportunities. Attributes such as creativity, curiosity, and design-thinking will be essential for the future workforce. People will no longer start a career path and only grow with one role, so nurturing competent lifelong learners becomes essential.

**Alter Educator Training**

American philosopher John Dewey said, "If we teach today's students as we taught yesterday's, we rob them of tomorrow." Even though he lived well before the beginnings of the 5th Industrial Revolution, his words are very appropriate today. Rather than teachers distilling information to students that they then memorize, teachers will become guides to help students facilitate their own learning and lines of inquiry. Failure needs to be embraced as an essential step to learning. Additionally, teaching will be much more personalized, which will be supported by bringing in technologies such as AI and machine learning.

### Make Schools Maker Spaces

To allow students to practice their curiosity, problem-solving skills, inquisitiveness and the iterations of failure, schools need to provide learning environments that will enable students to be creators using a wide variety of physical and digital tools. This can help equip children with the love of learning that will allow them to make sense of their world through hands-on experiences that emphasize collaboration and creativity.

### International Mindfulness

In a digital, interconnected world, employees of the future will need to have a global mindset. Schools and educators must adapt learning to take this into account. For example, history might not be taught from the perspective of one country but rather with examples from around the world; and instead of teaching the same languages that have always been taught, schools should look at international demand and the languages of emerging markets.

### Change in Higher Education

From how long degrees take to forging stronger ties between institutions of higher learning and industry, changes will need to be made to our post-secondary education learning to prepare students for the 5th Industrial Revolution adequately. During the 5th industrial revolution, college qualifications will become shorter and more focused, and colleges will provide more life-long education with modular post-graduate qualifications throughout the working lives of individuals. This will also impact how earlier education levels will need to modify their college preparatory classes. For example, it is essential that the seeds for this type of learning are set in schools by offering students the opportunity to learn topics beyond their core curriculum and develop a love for learning.

### CONCLUSION

Students will have to think creatively, communicate ideas, solve problems, and collaborate to come up with new ideas. By making changes in the guidelines, we can push students to keep thinking of the next step or iteration, to view learning as an ongoing process. We know that technology will continue to evolve at a rapid pace, so the best we can do is focus on helping students

to develop human skills such as creativity, initiative, resilience, and flexibility in learning. The more that we can connect students with innovative real-world opportunities within their school, community and globally, we will empower them to develop the skills they need to be successful in the future.

We must start by ensuring that all students have an equal opportunity to explore and discover their passions. By supporting our students as they set their own learning goals, engage in more self-driven learning experiences and to self-assess, we will provide them with a solid foundation and diverse skill set so they will be successful in the future, far beyond 2030.

The 5IR is likely to change modern education in significant ways, with a greater emphasis on STEM education, blended and personalized learning, soft skills and lifelong learning.

### REFERENCES

1. Azzah Al-Maskari, Thuraya Al Riyami and Sami Ghnimi (Nov.2022). Factors affecting students' preparedness for the fourth industrial revolution in higher education institutions, Retrieved 22 June 2023 from <https://www.emerald.com/insight/2050-7003.htm>
2. Birari, Santosh. (2024). एआय च्या रूपात पाचवी ओउद्योगिक क्रांती निशब्द करणारी, एस निवज.
3. Sawahel, Wagdy. (December 2021). Preparing 5IR-ready university graduates for the future economy, Retrieved 22 June 2023 from <https://www.universityworldnews.com/post.php?story=20211221061059135>
4. Marr, Bernard. (2019). 8 Things Every School Must Do To Prepare For The 4th Industrial Revolution Retrieved 22 June 2023 from <https://www.forbes.com/sites/bernardmarr/2019/05/22/8-things-every-school-must-do-to-prepare-for-the-4th-industrial-revolution/?sh=5134deeb670c>
5. University of Technology Sydney, (May, 2022). Preparing students for the fifth industrial revolution. Retrieved 21st Jan, 2023, from <https://www.uts.edu.au/news/education/preparing-students-fifth-industrial-revolution>.
6. World Economic Forum (May 2023). Future of jobs 2023: These are the most in-demand skills now - and beyond. Retrieved 22 June 2023 from <https://www.weforum.org/agenda/2023/05/future-of-jobs-2023-skills/>



# Fostering Sustainable Education with Artificial Intelligence in the Era of Industry 5.0

**Urmila R. Pol**

Associate Professor  
Department of Computer Science  
Shivaji University  
Kolhapur, Maharashtra  
✉ urmilec@gmail.com

**Tejashree T. Moharekar, Parashuram S. Vadar**

Assistant Professor  
Yashwantrao Chavan School of Rural Development  
Shivaji University  
Kolhapur, Maharashtra  
✉ ttm.50649@unishivaji.ac.in  
✉ psv.50321@unishivaji.ac.in

## ABSTRACT

The use of Artificial Intelligence (AI) and machine learning (ML) technology into the education system has gained considerable attention in recent years. This presents a great opportunity to promote sustainable growth. This paper examines the interaction between Artificial Intelligence (AI), Machine Learning (ML), and the Education System in the changing landscape of Industry 5.0. An analysis is conducted on the use of Artificial Intelligence (AI) and Machine Learning (ML) in education as a driving force for customized and adaptable learning experiences, fundamentally transforming instructional approaches and student involvement. The adoption of AI and ML in education brings forth opportunities for personalized learning experiences, adaptive assessment tools, and efficient administrative processes. These technologies enable the creation of intelligent tutoring systems that cater to individual learning styles, promoting inclusivity and enhancing overall educational outcomes. Additionally, AI-driven analytics and data-driven decision-making tools empower educators and policymakers to make informed choices, leading to the optimization of resource allocation and curriculum development.

**KEYWORDS** : *AI, Machine learning, Education system, Sustainable development, Industry 5.0.*

## INTRODUCTION

In the rapidly evolving landscape of Industry 5.0, the amalgamation of Artificial Intelligence (AI), Machine Learning (ML), and the Education System has emerged as a transformative force, presenting unparalleled opportunities for sustainable development. This integration not only redefines the traditional paradigms of education but also aligns with the interconnected and intelligent systems characterizing Industry 5.0. Establishing a sustainable future necessitates the presence of sustainable education, which encounters significant obstacles such as insufficient infrastructure, restricted resources, and a dearth of knowledge and involvement. AI has the capacity to tackle these difficulties and boost sustainable education by enhancing access to high-quality education, facilitating personalized learning experiences, and enabling data-driven decision-making. A result of utilising AI and IT

systems in sustainable education is the capacity to offer students tailored learning experiences that accommodate their individual learning styles and preferences. Furthermore, AI systems have the capability to offer teachers data-based observations regarding student performance, emotions, and levels of engagement. This allows teachers to customize their teaching methods and approaches, as well as provide appropriate support or intervention.

AI in education systems would significantly contribute to the achievement of sustainable development goals in India by 2030, while also addressing concerns pertaining to equality, equity, and inclusion in education. Artificial Intelligence (AI) will enhance and augment human intelligence, enhancing the quality of life and productivity in several aspects of human existence (IBEF, 2023).

## RELATED WORK

This new intersection of two fields has arisen as the research community has begun to investigate the potential uses of AI in SDGs. One common thread throughout these studies is the need to either (a) regulate the use of AI to fulfill the SDGs or (b) assess the effect of current AI techniques on SDG achievement. The spread of artificial intelligence in education is hindered by a lack of resources and infrastructure, which is just one of several issues faced by India's education sector. There exist significant socio-economic inequities in the Indian education sector. These inequalities exist on the basis of class and caste. For instance, A student from the top 20 per cent of society is ten times more likely to attend an English medium school than someone who belongs to the bottom 20 per cent (Anjali, 2022).

Efforts to prepare future workforces for artificial intelligence rely heavily on education. It will take more than just embracing more robust learning technologies to close the AI skills gap. This calls for a complete overhaul of how and what students learn in classrooms across all grade levels. The six pillars of knowledge that the framework highlights as being bolstered by digital technology are: Sections 1–6: Grasping the Role of Information and Communication Technologies in the Classroom; Section 2–3: Curriculum and Assessment; Section 4–5: Organisation and Administration; Section 6: Professional Development for Educators. The three stages of learning are outlined under the framework: 1-being literate in technology; 2-expanding one's knowledge; 3-acquiring new knowledge (UNESCO, 2019).

Both education and AI have the potential to complement one another. The education system in India has seen several significant reforms throughout the years, which has had a profoundly positive impact on the country's educational landscape. As the most recent technical development, AI has the potential to provide solutions that are sustainable, easy to understand, and open to all parties involved. The current educational system has holes that can be filled with AI-enabled technology. This article explores the main problems with the Indian education system and aims to offer remedies that are influenced by AI advancements that prioritize sustainability (Shalini & Tewari, 2020).

By making learning more efficient and tailored to each individual, AI might completely transform the educational system. Using AI, adaptive learning platforms can assess each student's unique abilities and areas of weakness, allowing for personalized lesson plans. The use of AI-powered virtual tutors can greatly improve the quality of education by offering students immediate feedback and tailored instruction (Aggarwal, 2023).

As the most recent technical development, AI has the potential to provide solutions that are sustainable, easy to understand, and open to all parties involved. The current educational system has holes that can be filled with AI-enabled technology. This article explores the main problems with the Indian education system and aims to offer remedies that are influenced by AI advancements that prioritize sustainability (Shalini & Tewari, 2020).

With the use of applications like LMSs and Intelligent Tutoring Systems, students can receive constant feedback on their performance, which makes evaluation much easier. One further option is to create individualized learning materials that can assess each student's progress and meet their specific requirements (Chassigno, Khoroshavin, & Alexandra, 2018).

New artificial intelligence (AI) tools in the classroom are quickly becoming a trend. It is becoming increasingly vital for the entire educational ecosystem to raise awareness of sustainable education and the SDG goals. Not only should teachers acquire the latest digital abilities in information and communication technology, but they need also be schooled in additional AI-powered ideas that could be used in educational systems. When it comes time to use the AI system, teachers will need to be familiar with pedagogical ideas and practices to ensure that everything is relevant (Lin, Huang, & Lu, 2023).

Artificial intelligence has progressed to the point where recommendation structures are useful. Machine learning algorithms allow recommendation systems to learn from user data and provide personalized recommendations. Based on the user's unique identity and traits, these applications tailor the information they display. Online retailers like Amazon and video-sharing websites like YouTube use user viewing histories to

suggest content that other users are likely to enjoy. The conversational assistant Alexa examines a wide variety of queries (and re-requests) in order to provide clients with individualized feedback, suggestions, and responses. To tailor recommendations to each individual user's preferences and traits, recommendation systems employ machine learning (Ramya & Manju, 2019).

AI-driven e-readers can provide personalized reading experiences, allowing students to highlight text, take notes, and search for information within digital textbooks. AI technologies can transcribe spoken words into text (speech-to-text) and convert text into speech (text-to-speech). This accessibility feature allows students to access content in various formats and reduces the need for printed materials. AI-powered note-taking apps and tools can help students create and organize digital notes, drawings, and annotations, eliminating the need for physical notebooks and printed lecture slides (Beard, 2020).

Business Today predicts that 47 percent of LMSs will have AI capabilities by the year 2024. Additionally, from 2019 to 2025, artificial intelligence is projected to attain a CAGR of 40.3% in the education market. Learning itself and the future of education will be shaped by the synergy between human educators and cutting-edge technological tools. Thanks to AI, educators will be able to get a deeper understanding of their students and do away with ineffective, outdated methods of instruction. We also think that introducing students to AI at a young age would encourage them to think creatively and learn all they can about this incredible technology, which is another major benefit of AI-based education (Saxena, 2022).

## EDUCATION FOR SUSTAINABLE DEVELOPMENT

Education for Sustainable Development is typically characterized as the cultivation of information, expertise, principles, and conduct necessary to establish a world that can be sustained throughout time. It is crucial to emphasize that the focus should be on education for sustainable development, rather than education about sustainable development. Tools and processes should be specifically built to facilitate the engagement of learners and educators at the local, national, and

international levels. Educational institutions must to foster the inquisitiveness of both instructors and students, equipping them with the necessary tools and resources to investigate, comprehend, actively participate in, and effectively convey the significance of sustainability. Educational institutions should take proactive measures to prepare for the implementation of Education for Sustainable Development, in anticipation of the rollout of the National Education Policy (NEP). ESD, or Education for Sustainable Development, is an educational approach that focuses on the following topics:



Source: Compiled By Researcher

## ROADMAP TOWARDS SUSTAINABLE EDUCATION

**Environmental Stewardship:** To foster sustainable education, it is imperative to build awareness among management, teachers, and students. This involves cultivating a comprehensive understanding of the principles and practices that contribute to sustainability within the educational ecosystem. Encourage leadership to adopt eco-friendly policies, incorporating sustainable practices in school infrastructure and operations. Promote environmentally conscious teaching methodologies and integrate sustainability into the curriculum. Instill a sense of environmental responsibility through programs, projects, and initiatives that involve students in sustainable practices.

**Resource Optimization:** Emphasize the efficient use of resources, implementing systems for energy conservation, waste reduction, and responsible procurement. Educate teachers on resource-efficient

classroom management and incorporate sustainable practices in lesson plans. Involve students in initiatives such as recycling programs, energy-saving campaigns, and community projects that optimize resources.

**Technology for Sustainability:** Explore AI and Machine Learning applications to streamline administrative processes, reducing the environmental footprint. Incorporate technology into teaching methods, fostering digital literacy and awareness of tech solutions for sustainability. Encourage the use of technology for research, collaboration, and projects that promote sustainable practices.

**Community Engagement:** Foster partnerships with local communities and businesses to create a network that supports and promotes sustainable education. Incorporate community-based projects into the curriculum, connecting classroom learning with real-world sustainability challenges. Engage students in community service projects that address local environmental issues, promoting a sense of responsibility and community awareness.

**Ethical and Inclusive Education:** Advocate for ethical considerations in decision-making, ensuring that the educational environment is inclusive and respects diversity. Embed ethical principles in teaching, fostering a sense of responsibility, empathy, and global citizenship. Promote inclusivity and respect among students through awareness campaigns, cultural exchange programs, and diversity-focused initiatives.

## ARTIFICIAL INTELLIGENCE FOR SUSTAINABLE EDUCATION

Using artificial intelligence (AI) for sustainable education can help make learning more accessible, efficient, and effective while also reducing its environmental impact.



Source: Compiled By Researcher

**Personalized Learning & Adaptive Content:** AI can create personalized learning paths for students by analyzing their strengths, weaknesses, and learning styles. This reduces the need for one-size-fits-all educational materials and minimizes waste. AI-powered content recommendations and adaptive learning platforms can suggest relevant resources, quizzes, and exercises based on individual progress, promoting more efficient learning. AI-driven tutors can provide instant feedback and guidance to students, reducing the need for additional human teachers and improving access to education, especially in underserved areas. AI-powered language translation tools can make educational materials available in multiple languages, breaking down language barriers and increasing global accessibility.

**Energy Efficiency:** Use AI to optimize energy consumption in educational institutions, such as smart lighting, heating, and cooling systems, reducing energy costs and carbon emissions. AI can create realistic virtual labs and simulations, reducing the need for physical resources and lowering the environmental impact of laboratory experiments. AI can analyze data related to educational processes, resource usage, and student performance to identify areas where sustainability improvements can be made. Promote the use of digital textbooks, e-books, and online materials to reduce paper usage and the environmental impact of printing.

**Predictive Analytics:** Use AI to predict and identify at-risk students who may need additional support or interventions, helping to prevent dropouts and wasted resources [8]. AI-powered virtual classrooms and remote learning platforms can increase access to education for students in remote or disadvantaged areas, reducing the need for commuting and physical infrastructure. Automate administrative tasks such as grading, scheduling, and record-keeping to free up educators' time and reduce the overall workload of educational institutions. Collect and analyze feedback from students and teachers using AI to make ongoing improvements to the educational experience and sustainability efforts.

**Collaboration and Knowledge Sharing:** AI can facilitate collaboration among educators and students



by recommending relevant resources, connecting people with similar interests, and fostering knowledge sharing. Ensure that the hardware used for AI applications in education is energy-efficient to minimize power consumption and reduce the carbon footprint. Use AI to track and report on sustainability metrics within educational institutions, such as energy usage, resource consumption, and carbon emissions, to raise awareness and drive improvement. Integrate ethical AI education into the curriculum to ensure that students are aware of the social and environmental implications of AI technologies. To successfully implement AI for sustainable education, it's crucial to consider the ethical implications, data privacy, and the potential digital divide, ensuring that AI benefits all learners and contributes to a more sustainable and equitable educational ecosystem.

Implementing Artificial Intelligence (AI) in education holds the potential to revolutionize the traditional learning landscape. By integrating AI technologies, educational institutions can enhance the overall learning experience for both students and educators. Different ways that can be integrated education with AI are mentioned below:

Machine Learning (ML) plays a significant role in formal learning by offering tailored and adaptive solutions. In formal learning settings, such as classrooms or online courses, ML algorithms analyze data on student performance and behavior. This analysis enables the creation of personalized learning experiences, adapting content and pacing to individual needs. Moreover, ML can assist in automating assessment processes, providing timely feedback to students and helping educators identify areas that may require additional attention. By leveraging ML, formal learning environments become more dynamic, responsive, and tailored to the unique requirements of each learner, ultimately enhancing the overall educational experience.

Natural Language Processing (NLP) is a versatile tool that finds application in both formal and informal learning environments. In formal learning, NLP can enhance language-related tasks, such as automated grading, providing instant feedback to students, and aiding in language instruction. Additionally, NLP can assist in developing intelligent tutoring systems,

offering personalized guidance and support. In informal learning settings, like online platforms and interactive applications, NLP enables chatbots, language translation services, and voice-activated assistants. This enhances user engagement and accessibility, allowing learners to interact with content in a more natural and conversational manner. NLP's ability to understand and generate human-like language bridges the gap between technology and learners, making it a valuable asset in both formal and informal educational contexts.

Computer Vision is a powerful tool that can be harnessed for both teaching and evaluation purposes. In teaching, Computer Vision technology allows for enhanced visual content in educational materials. It enables the creation of interactive and immersive learning experiences through visual recognition and interpretation. For instance, it can be utilized to explain complex concepts through augmented reality applications or to provide visual feedback in real-time during lessons. On the evaluation side, Computer Vision facilitates automated assessment processes. It can analyze and interpret visual data, such as images or videos, to assess student performance. This technology can be employed for grading assignments that involve visual elements, evaluating projects, or even monitoring practical demonstrations. By automating these processes, Computer Vision not only saves time for educators but also provides more objective and consistent evaluation results.

## CONCLUSION

Allocating resources fairly is crucial to the long-term viability of basic education development. The enrollment level of students in basic education is directly related to the amount of money the government allocates per capita. Put simply, we need to make huge expenditures in elementary and secondary schooling. Concurrently, legislative frameworks for limiting the use of modern technology must be developed and put into action. The potential for AI to revolutionize education lies in its ability to personalize, streamline, and expand access to quality education. But before we bring AI into classrooms, let's talk about privacy and ethical problems. We also need to make sure that AI helps teachers out, not takes their place. Instructors and educational institutions can benefit from AI-generated insights about learner performance. This



data can inform curriculum design, teaching strategies, and interventions for struggling students. Adaptive learning systems can efficiently handle large numbers of learners simultaneously, making education more accessible to a broader audience. AI-powered adaptive learning systems continue to evolve and improve as they collect more data and refine their algorithms. However, it's important to note that while AI can enhance the learning experience, it should complement, not replace, the role of teachers and educators who provide essential guidance, support, and mentorship in the learning process. By adopting AI-driven solutions, educational institutions can significantly reduce paper usage, lower printing costs, improve accessibility, and contribute to a more sustainable and eco-friendly learning environment. However, it's essential to ensure that digital access is equitable and that students and educators have the necessary tools and training to make the most of these technologies.

## REFERENCES

1. Aggarwal, D. (2023). Adoption of Artificial Intelligence (AI) For Development of Smart Education as the Future of a Sustainable Education System. *Journal of Artificial Intelligence Machine Learning and Neural Network* .
2. Anjali. (2022). Lack of AI policies in education is a significant challenge for India: UNESCO report. IndiaAi.
3. Beard. (2020). Can computers ever replace the classroom? Retrieved from <https://www.theguardian.com/technology/2020/mar/19/can-computers-ever-replace-the-classroom>.
4. Chassigno, M., Khoroshavin, A., & Alexandra. (2018). Artificial Intelligence trends in education: a narrative overview. *Procedia Computer Science*, (pp. 16-24). IBEF. (2023). FUTURE OF DATA SCIENCE AND AI IN INDIA. IBEF.
5. Lin, C.-C., Huang, A. Y., & Lu, O. H. (2023). Artificial intelligence in intelligent tutoring systems toward sustainable education: a systematic review. *Springer Smart Learning Environments*.
6. Ramya, P., & Manju, M. (2019). ARTIFICIAL INTELLIGENCE FOR SUSTAINABLE
7. EDUCATION IN INDIA: PROBLEMS AND PROSPECTS. *International Journal of Production Technology and Management (IJPTM)* , 135-143.
8. Saxena, P. (2022, Jan). AI impact on India: AI in education is changing India's learning landscape. INDIAAi .
9. Shalini, & Tewari, A. (2020). Sustainable Education in India through Artificial Intelligence: Challenges and Opportunities. *WebSci '20 Companion: Companion Publication of the 12th ACM Conference on Web Science*, (pp. 41–47).
10. UNESCO. (2019). *Artificial Intelligence in Education: Challenges and Opportunities for Sustainable Development*. France: United Nations Educational, Scientific and Cultural Organization.

# Critical Analysis of 5IR Skills Reflected in Syllabus of B.Ed-M. Ed (Integrated) Programme of Shivaji University, Kolhapur

Saraswati A. Kamble

✉ kamblesaraswati74@gmail.com

Anija A. Suryavanshi

✉ anijasuryavanshi@gmail.com

Research Scholars  
Shivaji University, Kolhapur

## ABSTRACT

The process of industrial revolution started in Britain in the 18th century and from there spread to other parts of the world. It was the transition from creating goods by hand to using machines. In modern history, it is indicated as the process of change from agrarian and handicraft economy to one dominated by industry and machine manufacturing. The journey from first to fifth industrial revolution brought drastic changes in growth and development of world's economy as well as framing societal mindsets. Fifth industrial revolution marked significant shift with the introduction of automation and artificial intelligence into various industries. As we navigate towards this future, it is crucial to impart skills that empowers our children to thrive amidst technological advancements. The key skills required for fifth industrial revolution are creativity, critical thinking and problem solving, adaptability, digital literacy, emotional intelligence, resilience and cross-cultural competency. Education system should prioritize fostering all these skills alongside core subjects, interdisciplinary studies and technology enabled education. Education 5.0 starts with humans not technology. Its purpose refers to explicitly to specific outcomes that need to be achieved by human as a result of particular learning experiences. It is not about providing technological gadgets and infrastructure to the learner instead it is about preparing intellectually, socially and emotionally strong individual, mindful of their health and personal development. It is followed by appropriate methodological and pedagogical approaches. It includes the ways to bring motivation, creativity and joy of learning back to learner. The present paper is research based paper which reveals the critical analysis of 5IR skills that are reflected in B.Ed-M.Ed(integrated) programme of the Shivaji University Kolhapur.

**KEYWORDS** : *Industrial revolution, 5IR Skills.*

## INTRODUCTION

The fifth industrial revolution encompasses 'The notion of harmonious human machine collaboration, with a specific focus on the well being of the multiple stakeholders (i.e. Society, companies' employees and customs)". The fifth industrial revolution is often associated with advanced technologies such as artificial intelligence, the internet of things, robotics and other emerging technologies. Implementing 5IR skills in education involves preparing students to thrive in rapidly changing technological landscape.

It is obvious that, Fifth Industrial Revolution refocuses to humanity and modifies our work approach and will not lead to the replacement of workers in automaton.

It will produce an employment opportunity for creative thinkers and AI specialists. It will also create a new role in manufacturing companies and will rename human resources department (HRD) as worker resources department as (WRD). This fifth generation industry brings customer satisfaction and opens new market-the advent of an experience driven manufacturing economy focused on providing satisfying customer experiences

In order to meet the needs of 5IR, Higher education needs to be future focused and technology driven. Higher education needs to develop courses and programs that are specifically tailored to the needs of the new economy. This means that classes should give students the skills and knowledge they need to do well in a world that change quickly.

### Benefits of 5<sup>th</sup> industrial Revolution in Education

5<sup>th</sup> IR has a number of benefits for students.

1. It gives students the skills and knowledge they need to do well in a world that change quickly.
2. It also provides them with the soft skills they need to be successful in the new economy.
3. It has the potential to reduce costs and increase efficiency.
4. It can cut down on the cost of training and development by giving students access to the latest technology.
5. It can also reduce the cost of recruiting and retaining employees.
6. It can help to make the workplace more efficient by making sure that workers know how to use the latest technology to its fullest.

### Objectives

1. To study the concept 5IR.
2. To study the benefits of 5IR in Education.
3. To analyze the syllabus of B.Ed-M.Ed integrated of Shivaji University Kolhapur with reference to 5IR skills.

### Methodology

The research paper mainly used secondary data. The relevant information that is used for the study was based on secondary sources from various research publications. The information gathered is from published reports, journals, publications as well as several websites of online journals etc. The majority of information gathered is from online blogs, articles and research papers. The key terms used for research included education and 5IR as well as industrial revolution.

Secondly for exploring the reflection of 5IR skills reflected in syllabus of B.Ed-M.Ed (Integrated) Programme ,the content analysis method was used to analyze the subject areas taught under the syllabus.

Key skills required for fifth industrial revolution

Following are the major skills that are important in 5<sup>th</sup>

Industrial Revolution :

### Creativity

The ability to think freely, generate innovation solutions and adapt to rapidly changing circumstances will give individuals a competitive edge in the workforce.

### Critical thinking and problem solving

Analyzing data, drawing insights and making evidence-based decisions will be vital. Algorithm and machines increasingly influencing decision making, individuals adept at critical thinking and problem solving will provide valuable contribution.

### Adaptability

Rapid changes in workforce necessitate adaptability. Our children must embrace lifelong learning swiftly acquire new skills and technologies and reality embrace change. Adaptable individuals will be well positioned to succeed in an ever evolving landscape.

### Communication and collaboration

Effective communication and collaboration skills will remain crucial even in an automated world. As teamwork and collaboration become more important individuals who can clearly express ideas actively listen and collaborate effectively with others will thrive there.

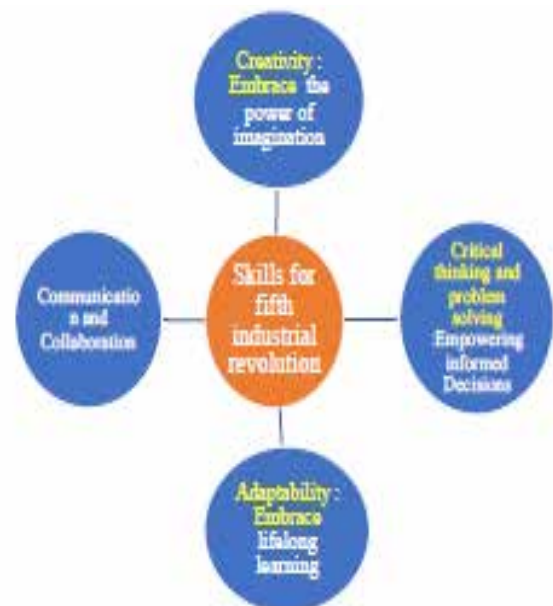

Fig 1: Fifth Industrial Revolution Skills

Some other more 5IR skills that are important for transforming Educational system are as follows:

1) Digital Literacy	Understanding online information Use of digital tools and platforms Understanding online information Evaluating sources Developing proficiency in digital communication
2) Critical thinking and Problem solving	Developing solutions to real world problems Think creatively Use of project-based learning Case studies
3) Coding and Computational Thinking	Develops abilities of logical thinking Breaking down problems into smaller and more manageable parts
4) Data Literacy	Ability to interpret and analyze data Emphasize data driven decision making Incorporating data analysis tools and activities in various subjects
5) Adaptability and Flexibility	Navigating unfamiliar situations Adapting new technologies Exposing students to diverse learning experiences Acquiring new skills
6) Interdisciplinary learning	Fostering holistic understanding of complex issues  Integrating interdisciplinary concepts from various subjects
7) Ethical Considerations	Responsible use of AI data privacy Ethical implication of emerging technological advancements
8) Entrepreneurship and innovations	Fostering an entrepreneur mindset Encouraging innovations and creativity
9) Continuous Learning	Instilling mindset of continuous learning Emphasizing the importance of staying curious Adapting technological advancement

10) Experiential Learning	Providing hands on experiential learning opportunities Applying theoretical knowledge in real world setting
11) Global Perspective	Incorporating global issues and examples into the curriculum Preparing students for a work force that transcends geographical boundaries
12) Teach - professional Development	Organizing workshops, training programs and ongoing support for teacher educators Introducing latest technological advancement and teaching methodologies
13) Feedback And Reflections	Encouraging regular feedback and reflections on learning experiences of student Developing habit of continuous improvement
14) Real World Application	Connecting classroom learning to practical examples and industry applications

**Fig: Fifth Industrial Revolution Skills**

**Syllabus of B.Ed – M.Ed (Integrated)**

Syllabus of B.Ed – M.Ed (Integrated) proposed by Shivaji University contains 6 semesters which provides versatile and diversified learning experiences holistically and prepares the future teachers and teacher educators to face the upcoming trends of 5IR.

**Table 1: 5IR Skills and Strategies Reflected in Three year integrated B.Ed- M.Ed Program of Shivaji University Kolhapur**

Sem I		
Sr. no.	Theory	Integrated skills and Strategies
1	Philosophy of Education	Cross cultural competency, Ethical consideration
2	Sociology History and Political Economy of Education	Interdisciplinary learning
3	Childhood and growing up	Emotional intelligence

4	Understanding disciplines and subjects	Interdisciplinary learning
<b>Practicum</b>		
	ICT and ET workshop	Mastery in Technology communication skills, Adaptability and Flexibility, Ethical consideration
	General communication skills	Communication and collaboration
	English communication	Communication and collaboration
<b>Internship I</b>		
	T.E. Internship as per specialization	Experimental learning
	Classroom observation	Experimental learning
	Micro teaching skills	Teaching Professional Development
	Visit to innovative schools and classroom observation and maintaining reflective diary	Communication and feedback, Teaching Professional Development, feedback and reflection
<b>Sem II</b>		
1	Psychology of learner; Learning Process and Assessment for learning	Ethical and societal value
2	Basic of Research, action research and statistics	Innovativeness problem solving
3	Teacher and teaching process	Professional development Skills
4	Pedagogy of school subjects-I	Interdisciplinary approach
<b>Practicum</b>		
	Formulation of research proposal	Creativity, innovation, critical thinking
	Education workshop	Data literacy
	Lesson planning, demonstration of model lesson workshop	Creativity
	Instructional aid workshop	Creativity

	Workshops on constructivist approach	Creativity, innovation, critical thinking
	Working with community	Real life experiences
<b>Sem III</b>		
1	Education studies	Interdisciplinary approach
2	Advanced Educational Research and Statistics	Creativity, innovation, critical thinking, data interpretation and analysis, Data literacy
3	Pedagogy of school subjects-II	Interdisciplinary approach
4	Educational guidance and counseling	Adaptability, Emotional intelligence
5	Environmental Education	Sustainability practices
<b>Practicum</b>		
	Presentation of Research Proposal	Digital literacy
	Preparation of tools for data collection	Digital literacy
	Self-development and Yoga education	Adaptability, Emotional intelligence
	Action Research	Real life experiences, Problem solving
	Internship	Real life experiences
<b>Sem IV</b>		
1	Teacher Education	Professional skills
2	Specialization - Teaching and learning process in elementary education	Interdisciplinary approach
3	Specialization - Teaching and learning process in secondary education	Interdisciplinary approach
4	Specialization Curriculum and evaluation in elementary school	Interdisciplinary approach
5	Specialization Curriculum and evaluation in secondary school	Interdisciplinary approach



6	Optional paper Educational measurement and evaluation Comparative education	Data literacy, data literacy
<b>Practicum</b>		
	<b>Data collection analysis</b>	<b>Data literacy</b>
	Interpretation	Digital literacy
	Internship III	
	ABL, ICT- Model	Digital literacy
	Expository writing	Analytical skills
	Academic writing	Reflection and feedback
	Self-development and gender sensitization	Ethical and societal value
	Educational tour	Real life experiences
	Exposure to curriculum and textbook agencies	Communication and collaboration
	Policy making body	Real life experiences
	State education department visit to educational institution	Real life experiences
<b>Sem V</b>		
	Compulsory paper	
1	Gender, school and society	Adaptability, Emotional intelligence
2	Educational Administration, Management and Economics of Education	Experiential Learning, communication and collaboratve skills
3	Open and distance learning	Digital literacy
4	Optional paper Human Rights Education Inclusive Education	Gender sensitization
<b>Practicum</b>		
	Final Research Submission	Analytical and Interpretational skills
	Internship IV and V	
<b>Sem VI</b>		
	<b>Compulsory papers</b>	

1	Curriculum studies	Interdisciplinary studies
2	Contemporary concerns and issues in Education	Lifelong learning
	<b>Optional</b>	
3	Ethics, Universal Human values and Peace Education	Ethical and societal value
4	Health and physical education	Emotional intelligence, harnessing human touch
<b>Practicum</b>		
	Yoga education	Emotional intelligence, harnessing human touch
	Visits to- Centers for under privileged groups/special schools/slum area and report writing	Emotional intelligence, harnessing human touch
	Employability skills workshops	Professional development Skills
	Working with community	Entrepreneurship skills
	Final Research Report	

**Observations**

From the table no: 1 it was observed that.

1. Syllabi of B.Ed-M.Ed (Integrated) of Shivaji University Kolhapur is three year program that includes 6 Semesters.
2. Total No. of Theory papers including compulsory, specialization as well optional are almost 30. From which along with theory paper, students have to choose optional Subjects. Each Semester includes variety of practicum.
3. With Reference to 5IR skills, Creativity, critical thinking, Innovativeness, Digital literacy and Data literacy are explored in Theory papers of Sem II, III&IV and practicum Sem III.
4. Other skills like Adaptability, Emotional intelligence, Ethical consideration, Interdisciplinary learning, Experimental learning, Feedback and reflection are explored in Theory papers of Sem I, II, III, IV, V, VI and practicum of Sem I, III, IV, VI.

### Interpretation

From the above observations it is interpreted that all 5IR skills are reflected in the various theory papers and the practicum of semesters I-VI of syllabus of B.Ed –M.Ed (Integrated) programme

### CONCLUSION

The new era of technological advancement and innovation revolutionizing the way we live and work. To ensure successful transition, it is imperative that our education system should adapt the changing landscape and equip learner with necessary skills. Creativity, critical thinking and problem solving, adaptability, communication and collaboration are the key skills required for fifth industrial revolution. While analyzing the reflection of 5th Industrial Revolution (5IR) skills into B.Ed., M.Ed (Integrated) Programme, it was observed and interpreted that all types of 5IR are integrated in different content areas and practicum. These 5IR skills can be enhanced by using strategies like digital literacy and educational technology, curriculum design and integration, pedagogical approaches, assessments methods and lifelong learning, research and innovation in education, ethical consideration of technological use, internship and practical experiences as well as global perspective in education are the

content areas which enhance development of 5IR skills in learner. To achieve the goals of 5IR, much attention should be given to the study innovation technology and workforce qualification. This can be achieved through successful implementation of 5IR skills and strategies in every curriculum of education.

### REFERENCES

1. Murray Atholl The fifth Industrial Revolution: Preparing or children for future. Article published June 21, 2023, <https://www.linkedin.com/pulse>
2. George A. Industrial Revolution 5.0. The transformation of the modern manufacturing process to enable man and machine to work hand in hand. <https://reserachgate.net>
3. Nidhi Singh Unlocking the potential of IR 5.0: How Education 5.0 can meet the needs of industry 5.0
4. 4IR, 5IR society 5.0 and values in Education IIUM Journal of Educational studies (ARABIC) 11:1 (JUN 2023) 1-2 ISSN: 2289-8085
5. Education 5.0 Rehumanizing Education in the age of Machines html. <http://www.linkedin.com>.
6. Embracing fifth industrial Revolution, <https://www.sciencedirect.com/science/article>
7. National Geographic Education.org, <https://www.nationalgeographic.org/society/education-resources/>
8. 5IR <https://pdf.sciencedirectassets.com>

# Fostering Sustainable Development Competencies: A Study on Awareness Among D.Ed Students

**Sangeeta K. Chandanwale**

Research Student

Shivaji University

Kolhapur, Maharashtra

✉ sangeetachandanwale@gmail.com

**Vidyanand S. Khandagale**

Assistant Professor

Department of Education

Shivaji University

Kolhapur, Maharashtra

✉ vsk\_edu@unishivaji.ac.in

## ABSTRACT

Education for sustainable development constitutes a pedagogical approach designed to cultivate awareness, competence, knowledge, skills, and attitudes in environmental protection, ensuring that every facet of its implementation contributes to meeting the needs of future generations. In response to pressing environmental and social challenges, these competencies necessitate substantial revisions in curricula, aligning with the goals of a sustainable and innovative economy. This research investigates the awareness of sustainable development goals among D.Ed (Diploma in Education) students. Specifically, participants were drawn from Teachers Junior College of Education in Tasgaon, Rajmata Adhyapak Vidyalaya Sangli, and Sanmitra College Kolhapur. The study utilized the Sustainable Development Goals Awareness scale/Questionnaire to gather responses. Results indicate that a majority of students demonstrated awareness of the Sustainable Development Goals. In terms of sustainable development awareness, the highest average response (56%) indicated constant awareness, while 55% responded intermittently, and 47.5% reported never being aware. Furthermore, 48.5% of students agreed with certain statements, 5% disagreed, and 7% remained indecisive on some questions."

**KEYWORDS** : *Awareness, Education for sustainable development.*

## INTRODUCTION

The purpose of sustainable development is to achieve human development objectives while preserving natural systems' ability to give humans access to the resources and ecosystem services they depend on. The intended outcome is a civilization in which resources and living conditions satisfy human needs without jeopardizing the stability and integrity of the planet. A balance between social progress, environmental preservation, and economic growth is sought after by sustainable development.

The examination of the fundamental skills of sustainable development is, in our opinion, among the non-professional realm's most intriguing and interesting areas of study capabilities. In response to the 1987 report submitted by the Brundtland Commission to the World Commission on Environment and Development, the notion of sustainable development which aims to meet

both the demands of the current generation and ensure life on Earth for future generation was created. Since then, the idea has evolved in a number of spheres of life. One path the concept of sustainable development is taking is the formation of several and the enhancement of future professionals' competencies to accomplish sustainable development.

All students, regardless of age, may confront interrelated global issues like climate change, biodiversity loss, unsustainable resource use, and inequality by gaining the information, skills, values, and agency that Education for Sustainable Development (ESD) provide. It gives students of all ages the knowledge and skills they need to make wise decisions and take both individual and group action to improve society and our world. A vital component of a high-quality education, ESD is a process of lifelong learning. It benefits learning's cognitive, socio-emotional, and behavioral aspects and

includes teaching, learning objectives, and the actual learning environment.

The fields include education and teaching, management and economics, computer technology, psychology, and health care and other scientific fields are among the scientific domains where research is conducted to enhance students' competences essential for sustainable development.

Achieving many other Sustainable Development Goals (SDGs) will depend on education. People can escape the cycle of poverty when they have access to high-quality education. Everyone is empowered by ESD to make well-informed decisions that promote economic sustainability, environmental integrity, and just a society for both the present and the future. It strives to give the knowledge, skills, attitudes and values necessary to meet sustainable development concerns.

## REVIEW OF LITERATURE

Jati, Hafsa Fajar, (2019): Researched about regarding . "Awareness and knowledge assessment of sustainable development goals among university students." . This study aims to assess the level of awareness and knowledge of the Sustainable Development Goals (SDGs) among Indonesian university students. In this study, chi-square and descriptive statistics were used to examine the data. According to the statistics, 89.5% of students are aware of the SDGs, and 62.5% have a good level of awareness about them. We discovered that students' awareness was correlated with both gender and information accessibility, and that students' knowledge was solely impacted by information accessibility. Participation in the organization by students has no effect on awareness or knowledge.

Mahat, H., & Idrus, S. (2016). Education for Sustainable Development in Malaysia: A Study of Teachers' and Students' Awareness In terms of addressing development demands and environmental conservation issues, sustainable development is considered to be the most active and effective modern development concept. This study focuses on two factors that influence teachers' and students' perceptions of education for sustainable development (ESD)—school location and participation in the Sustainable School Environment Awards (SLAAS) program.

Primary data were obtained from 6 metropolitan secondary schools and 6 rural secondary schools with a total of 447 students and 245 teachers participating in the SLAAS program. The findings of the statistical analysis showed that there was no difference in content knowledge, attitude and behavior of students in rural and urban areas, but there was for teachers.

Michael, Sumilan, Bandar, N. F. A., Hamidi , Jonathan, & Nor, N. M. (2020). Studied Sustainable development concept awareness among students in higher education: A preliminary study Higher education institutions are primarily knowledge producers, and by teaching students about the importance of sustainable development, they can be an effective tool for building a more sustainable future. The purpose of this study is to survey The knowledge, perspectives, and behaviors of students regarding sustainable development. The research was carried out at a public institution in Kota Samarahan, Malaysia. Based on the UNESCO-provided learning objectives, a questionnaire was created, and the ANOVA test was used to analyze the data that was gathered. The survey included 79.2% (N=507) of the students enrolled in the same program. The findings showed that 40.7% (N=239) of the students polled knew too little about sustainable development

### Statement

"Fostering Sustainable Development Competencies: A Study on Awareness Among D.Ed Students"

### Objectives

- To Study Awareness of Sustainable Development Goals Among D.Ed Students.

### Definition

- D.Ed

Diploma in Education is a diploma-level teacher training programme that helps in becoming teachers at the elementary level, especially in government schools.

- Sustainable development

"Sustainable development is development that achieves the satisfaction of human needs forever and the improvement of the quality of human life."— Robert Allen

- Awareness

To raise/heighten/increase public awareness of something (Oxford Dictionary)

### Methodology

A study design survey was used for collecting data in this research

### Research Design

This research investigates the awareness of sustainable development goals among D.Ed (Diploma in Education) students. Specifically, participants were drawn from Teachers Junior College of Education in Tasgaon, Rajmata Adhyapak Vidyalaya Sangli, and Sanmitra College Kolhapur. The study utilized the Sustainable Development Goals Awareness scale/Questionnaire to gather responses. 94 students took part in a questionnaire survey. Based on the findings, suggestions and support are made for further ESD implementation in an effort to raise students' awareness, knowledge, and proficiency in sustainability and to promote their involvement in it through education. To enhance comprehension of the educational setting, the attentional quotient of students, their self-reported knowledge and information sources regarding the SDGs, and the manner in which their personal and professional decisions impact the SDGs.

## FINDINGS AND DISCUSSION

- I reduce my usage of electricity by plugging in power strips for all of my appliances, including my computer, and shutting them off entirely when not in use.. To this questions (60%) students were found to respond always, while (29.7%) students sometimes and (3%) very few students were found to respond never.
- I prefer to receive my bank statements on paper and pay for things with my computer or phone.. To this questions (62.7%) students were found to always respond while (30.8%) students were found to respond sometimes and (4.2%) never.
- I Cut the lights off. Turn off any extra lights if not in use because the TV or computer screen creates a cozy glow.. To this questions (68%) students were found to respond always while (13.8%) students responded sometimes and (5.3%) to a lesser extent never.
- I denounce cyberbullies. I should report someone who is harassing others on a message board or in a chat room.. To this questions (80.8 %) students were found to respond always while (12 .7 %) students were found to respond sometimes and (5.3 %) to a lesser extent never
- I keep myself updated. Keep up with the Global Goals by visiting @GlobalGoalsUN on social media or by following our local news.. To this questions (78.8 %) students were found to respond always while (17 %) students were found to respond sometimes and (1%) to a lesser extent never.
- I use the hashtag #globalgoals on social media to inform us about the steps we are doing to accomplish the global goals.. To this questions (35 %) students were found to respond always while (54 %) students responded sometimes and (7.4 %) to a lesser extent never.
- I reduce the residual carbon footprint we have! My carbon footprint is calculated, and I buy climate credits from Climate Neutral Now. This helps you cut emissions more quickly on a worldwide scale To this questions (43.6 %) students were found to respond always while (22 %) students were found to respond sometimes and (31.9 %) to a lesser extent never.
- Rather to using a dryer, I allow my clothes and hair to air dry naturally. As you wash my items, make sure the load is fully loaded. To this questions (91.4 %) students were found to respond always while (5.3 %) students were found to respond sometimes and (2 %) to a lesser extent never
- I just take quick showers. Given that a bathtub uses tons more water than a five to ten minute shower. To this questions (43.6 %) students were found to respond always while (22 %) students were found to respond sometimes and (31.9 %) to a lesser extent never.
- I consume fewer fish, poultry, and beef. Since producing meat requires more energy than producing plants. To this questions (50 %) students were found to respond always while (32.9 %) students were found to respond sometimes and (14.8 %) to a never.



- If you can't eat leftovers or fresh produce before it goes bad, I freeze them.. To this questions (39 %) students were found to respond always while (24 %) students responded sometimes and to a (34 %) never.
- I Compost: Recycling nutrients and lowering greenhouse gas emissions are two benefits of composting food leftovers. To this questions (17%) students were found to respond always while (1%) students responded sometimes and (79%) to a never.
- Paper, plastic, glass, and aluminum are all recycled by me.. To this questions (28.7%) students were found to respond always while (12.7%) students responded sometimes and (56%) to a never.
- I don't purchase many packaged goods. To this questions (32.9 %) students were found to respond always while (8 %) students were found to respond sometimes and (55 %) to a never.
- I do not preheat the oven in advance. To this questions (14.8 %) students were found to respond always while (8 %) students were found to respond sometimes and (74 %) to a lesser extent never.
- I Seal gaps in air leaks around doors and windows to improve energy efficiency.To this questions (28.7%) students were found to respond always while (11%) students responded sometimes and to a lesser extent (56%) never.
- During winter, I set the thermostat lower, and during summer, higher. To this questions (36 %) students were found to respond always while (12 %) students were found to respond sometimes and (44 %) to a lesser extent never.
- I swap out my outdated appliances for energy-saving models and upgrade my lightbulbs. To this questions (34%) students were found to respond always while (9.5%) students were found to respond sometimes and (52%) never.
- I purchase a rug. My house is kept warm by the carpets and rugs, and your thermostat is kept low. To this questions (54%) students were found to respond always while (35%) students were found to respond sometimes and (5%) never.
- When I need to wash dishes, I turn on the faucet.. To this questions (1 %) students were found to respond always while (2 %) students were found to respond sometimes and (94 %) never.
- I make use of cardboard matches.. They don't require any petroleum, unlike plastic gas- filled lighters. To this questions (60%) students were found to always respond, while (1%) students were sometimes and (3%) were never.
- I support local businesses. Encouraging local companies helps keep people employed and reduces the need for trucks to travel great distances.. To this questions (27%) students were found to respond always while (1%) students were found to respond sometimes and (65%) never.
- I Shop Wisely: make a menu, stick to it, and avoid impulsive purchases .To this questions (60%) students were found to always respond, while (1%) students were sometimes and (3%) were never.
- Why I Purchase Funny Fruit: A lot of fruits and vegetables are discarded because they are not the "correct" size, shape, or color.. To this questions (13%) students were found to respond always while (1%) students were found to respond sometimes and (81%) never.
- "Do you serve sustainable seafood?" is a question I usually ask when I order seafood at a restaurant. To this questions (25%) students were found to respond always while (15%) students were found to respond sometimes and (52%) never
- I only purchase sustainably farmed fish.. To this questions (29%) students were found to respond always while (5%) students were found to respond sometimes and (62%) never.
- I like to walk, ride my bike, or use public transportation.. To this questions (32%) students were found to respond always while (2%) students responded sometimes and (63%) never.
- I make use of a reusable coffee cup and water bottle.. To this questions (9%) students were found to respond always while (9%) students were found to respond sometimes and (79%) never.

- When I shop, I bring my own bag.. To this questions (1%) students were found to respond always while (1%) students were found to respond sometimes and (95%) never
- I use fewer paper towels.. To this questions (34%) students were found to respond always while (31%) students were found to respond sometimes and (31%) never
- I buy vintage and try to find new uses for items from thrift stores.. To this questions (90%) students were found to always respond, while (6%) students were sometimes and (30%) were never.
- I take care of my car and bike.. To this questions (92%) students were found to respond always while (0%) students were found to respond sometimes and (3%) never.
- Anything I don't use, I donate. To this questions (21%) students were found to respond always while (4%) students were found to respond sometimes and (73%) never.
- I vaccinate my family members as well as myself.. To this questions (6%) students were found to respond always while (0%) students were found to respond sometimes and (91%) never.
- I exercise my freedom to choose the leaders of your nation and neighborhood.. To this questions (6%) students were found to respond always while (6%) students were found to respond sometimes and (85%) never.
- I give away any fruit or snacks that I don't want to someone who is in need or who is requesting assistance. To this questions (56%) students were found to always respond, while (1%) students were sometimes and (3%) were never.
- I keep myself updated. Learn about international labor laws and corporate policies. Talk about these concerns with my friends and coworkers.. To this questions (3%) students were found to respond always, while (1%) students were sometimes and (93%) were found to be never.
- Does your organization or corporation make investments in dependable and clean infrastructure? It's the sole method to safeguard the environment and ensure worker safety.. To this questions (3%) students were found to respond always, while (1%) students were sometimes and (93%) were found to be never.
- I speak out against all forms of prejudice at my place of employment or institution. All people are created equal, regardless of their physical abilities, social background, gender, ethnicity, or sexual orientation. To this questions (10%) students were found to respond always while (1%) students were found to respond sometimes and (85%) never.
- Arrange a work-related No Impact Week. Try living more sustainably for a week or longer: [be-the-change.un.org/sustainable-development](http://be-the-change.un.org/sustainable-development). To this questions (70%) students were found to always respond, while (6%) students were sometimes and (3%) were never.
- I Take a Stand! Request that our government and firm take part in projects that won't hurt people or the environment. Speak up in favor of the Paris Agreement! To this questions (90%) students were found to always respond, while (8%) students were sometimes and (2%) were never.
- I make an effort to decrease garbage because the majority of it ends up in our oceans. To this questions (93%) students were found to always respond, while (1%) students were sometimes and (3%) were never.
- I consider and alter daily choices. Does your place of employment recycle? Does your organization purchase goods from vendors who use destructive environmental practices? To this questions (75%) students were found to always respond, while (20%) students were sometimes and (40%) were never.
- I post intriguing content on social media around women's rights or the environment.. It was found that (74%) students agreed with this statement while (9%) students disagreed and (13%) could not say.
- If I could put solar panels in our home, I would. It was found that (90%) students agreed with this

statement, while (2%) students disagreed and (5%) could not say.

- Select a better-fitting diaper. Use cloth diapers for your infant or switch to a new, eco- friendly disposable brand.. It was found that (56%) students agreed with this statement while (9%) students disagreed and (30%) could not say.
- Healthcare should be available to all employees.. It was found that (97%) students agreed with this statement while (1%) students disagreed and (0%) could not say.
- For doing the same task, women are paid between 10% and 30% less than males. There is persistent pay inequality worldwide. Speak up in favor of equal compensation for equal work.. It was found that (93%) students agreed with this statement while (3%) students disagreed and (1%) could not say.
- 4 billion people do not have access to basic hygienic facilities. Raise your voice to draw attention to the dearth of restrooms in many global communities It was found that (86%) students agreed with this statement while (5%) students disagreed and (6%) could not say.
- Verify that your business or institution uses energy-efficient heating and cooling systems, and set the thermostat to a lower setting in the winter and a higher setting in the summer. It was found that (96%) students agreed with this statement while (1%) students disagreed and (2%) could not say.
- You should be aware of your rights at work in order to ensure that you can get justice.. It was found that (96%) students agreed with this statement while (1%) students disagreed and (2%) could not say.
- Why Corporate social responsibility, in my opinion, matters! I urge my organization to collaborate with civil society and look for methods to assist local communities in achieving their objectives. It was found that (60%) students agreed with this

statement while (20%) students disagreed and (40%) could not say.

## CONCLUSIONS

Results indicate that a majority of students demonstrated awareness of the Sustainable Development Goals. In terms of sustainable development awareness, the highest average response (56%) indicated constant awareness, while 55% responded intermittently, and 47.5% reported never being aware. Furthermore, 48.5% of students agreed with certain statements, 5% disagreed, and 7% remained indecisive on some questions."

## REFERENCES

1. Jati, Hafsa Fajar, (2019): "Awareness and knowledge assessment of sustainable development goals among university students." *Jurnal Ekonomi & Studi Pembangunan*
2. Mahat, H., & Idrus, S. (2016). Education for sustainable development in Malaysia: A study of teacher and student awareness. *Geografia*,
3. Michael, Sumilan, Bandar, N. F. A., Hamidi, Jonathan, & Nor, N. M. (2020). Sustainable development concept awareness among students in higher education: A preliminary study. *Journal of Sustainability Science and Management*,
4. Jeffrey, D.S. From Millennium Development Goals to Sustainable Development Goals. *Lancet* 2012
5. <https://marathivishwakosh.org/62283/> <https://en.unesco.org/themes/education/sdgs/material>
6. <https://elicit.com/?workflow=table-of-papers&run=4e360da3-6c53-4103-9ad1-b7ab741347f3>
7. <http://journalarticle.ukm.my/10314/1/9x.geografia-siupsi-meil6-Hanifah-edam1.pdf>
8. <https://elicit.com/?workflow=table-of-papers&run=10d27fab-13fc-4286-afbe-7072d079daab>
9. <https://www.unesco.org/en/education-sustainable-development/need-know#>:
10. [https://en.wikipedia.org/wiki/Sustainable\\_development](https://en.wikipedia.org/wiki/Sustainable_development)
11. <https://files.eric.ed.gov/fulltext/EJ1314300.pdf>

# Nurturing Sustainability: Unveiling UN's Sustainable Development Goals in Educational Practices at Shivaji University - A Case Study

## Seema R. Pal

Student of B.Ed. - M.Ed. (Integrated)  
Shivaji University  
Kolhapur, Maharashtra  
✉ seemapal979@gmail.com

## Vidyanand S. Khandagale

Assistant Professor  
Department of Education  
Shivaji University  
Kolhapur, Maharashtra  
✉ vidyanandkhandagale@gmail.com

## ABSTRACT

Sustainable Development Goals (SDGs) help to transform the world by addressing issues such as poverty, injustice, and environmental conservation, and ensuring the well-being and prosperity of all individuals. The 2030 Agenda for Sustainable Development, endorsed by all nations in the UN in 2015, outlines 17 interconnected goals with 169 targets. Incorporating SDG targets in educational practices in the university can provide a means to inculcate the sensitivity towards environment and resources among the students through teaching-learning.

This qualitative research paper focuses on the case study method to examine the practices of Shivaji University, Kolhapur, in promoting Education for Sustainable Development (ESD). The institution emphasizes incorporating sustainable development principles into education to raise awareness and proficiency among students. Data was gathered through interviews with university officials and analysis of the official website.

The Research reveals varying levels of progress for each SDG, with some goals showing more accomplished SDG targets concerning educational practices than others. Goals 3,5,6,7,9 (Good Health and Well-being, Gender Equality, Clean Water and Sanitation, Affordable and Clean Energy, Industry, Innovation, and Infrastructure) respectively are identified as having advanced significantly in the action plan. Goals 10,11,12,17 (Reduced Inequalities, Sustainable Cities and Communities, Responsible Consumption and Production, Partnerships for the goals) respectively need to be catered and attempts should be made for attaining sustainable development through educational practices.

**KEYWORDS** : *Nurturing, Sustainability, Educational practices of SDGs.*

## INTRODUCTION

The objective of Sustainable Development Goals (SDGs) is to bring about a fundamental shift in our global environment. During the United Nations Conference on Sustainable Development in Rio de Janeiro in 2012, SDGs were proposed. The Agenda of 2030 and its Goals inhibit the vision for sustainable development which is global, not just limited to the “developing” countries unlike the Millennium Development Goals (MDGs); which was based on equity

and respect for humans. SDGs have been intended to mitigate Inequality and poverty, and protect the planet, hence ensuring justice, prosperity, and healthy living. All the countries of the United Nations adopted the Agenda for Sustainable Development of 2030 in 2015. The progress of SDGs are measured through indicators which includes a total of 17 Goals, consisting of 169 targets.

The 17 Sustainable Development Goals focus on building sustainable development at global level.

Therefore, to fulfil and take care of the needs of future generations, the available resources had to be used wisely and hence preserving our planet and natural resources by building a sustainable future became a dire need. According to the United Nations Brundtland Commission (1987) sustainability is defined as “meeting the needs of the present without compromising the ability of future generations to meet their own needs.” Hence to achieve SDGs, sustainability must be taught to the students which can help them to understand the importance of protecting the environment and natural resources for future generations. The students being the future becomes the perfect medium for practicing sustainability.

Hence the very purpose of Higher Education is to actively contribute to the SDGs achievement with the help of teaching-learning, research, engaging with the community, and services of non-academic and practices in management. Shivaji University's practices in Sustainable practices imply determination towards global sustainability, aligning goals with the UN's 17 SDGs. The emphasis on ESD incorporates sustainable education, research, and extracurricular activities.

## LITERATURE REVIEW

Mitter's (2016) carried analysis of SDG 4 which exposes tensions between transformative and pro-growth perspectives, emphasizing the dominance of a utilitarian approach prioritizing STEM and vocational skills within neoliberal capitalism. Ataya (2018) emphasizes universities' pivotal role in SDG achievement, advocating for partnerships with governments and communities. Similarly for universities to embrace sustainability strategies, utilizing "living labs" and emphasizing collaboration for SDG achievement was put forth by Purcell (2019).

The research of McCowan's (2021) delves into higher education's role in SDG achievement, documenting university activities and assessing their societal impact. An exclusive report from the proceedings of PACT2030 Conclave Goa (March 2022) of Indian Higher Education Institutions Best Practices towards SDGs revealed that the Best practices in integrating SDGs into university frameworks has been significantly practiced by Alliance University, Chitkara University, Chitkara University,

MIT World Peace University, NIMS University, NIET Greater Noida, O. P. Jindal Global University, Siksha 'O' Anusandhan Deemed University, Saveetha Institute of Medical and Technical Sciences, Shoolini University, UPES. Maximum efforts of these universities have been towards 3,6,7,10,12 (Good Health and well-being, Clean Water and Sanitation, Affordable and Clean Energy, Reduced Inequalities, Responsible Consumption and Production) respectively.

According to Amanda (2023) higher education globally engages with the UN's SDGs, highlighting widespread recognition of collaborative opportunities. Similar studies regarding Higher Studies was conducted by Ashida (2023) exploring the link between SDG 4 and higher education, stressing the role of Higher Studies in addressing SDG challenges. The study calls for equitable integration of academia and society, emphasizing regional and international cooperation in science and technology.

## Objectives of the Study

- 1) To identify the educational practices conducted by Shivaji University in the institutionalization of Sustainable Development Goals.
- 2) To analyse the identified educational practices of Sustainable Development Goals conducted by Shivaji University.
- 3) To study the perceived challenges in implementation of SDG practices through Interview analysis.

## Plan and Procedure of the Research

Type of research: Researcher adopted a qualitative approach for the present study.

Research Methodology: The researcher adopted case-study method as a qualitative approach in order to achieve the objectives of the present study.

Research Design: The research design consists of 6 phases. Phase 1: SDG themes were thoroughly studied.

Phase 2: Semi-structured Interview was prepared.

Phase 3: University's official website has been thoroughly revised Phase 4: Data was collected through Semi-structured Interviews with University stakeholders and qualitative analysis of the official website, documents, policies, audits, of Shivaji University



Phase 5: Metrics were designed for the analysis of collected data and Educational Practices attaining SDG targets were identified.

Phase 6: Analysed data was interpreted to identify the maximum educational practices with reference to SDG target.

Sampling design: The researcher adopted a purposive sampling design. The official website of Shivaji University, Kolhapur, unishivaji.ac.in was used for qualitative data analysis. The obtained data was simultaneously verified with higher authorities through interviews to get more clarity with reference to educational practices.

### Tools and Techniques for data collection

The researcher used semi-structured interview for the present study to get an in- depth analysis of the educational practices of SDG targets.

### DATA ANALYSIS:

**Table 1: Total no. of SDG targets and SDG targets in educational practices by Shivaji University, Kolhapur**

SDG	Total No. of Targets	Educational Practices of SDGs at SUK
1 (No Poverty)	7	2
2 (Zero Hunger)	8	2
3 (Good Health and Well-being)	13	5
4 (Quality Education)	10	3
5 (Gender Equality)	9	5
6 (Clean Water and Sanitation)	8	7
7 (Affordable and Clean Energy)	5	2
8 (Decent Work and Economic Growth)	12	2
9 (Industry, Innovation and Infrastructure)	8	3
10 (Reduced Inequalities)	10	1
11 (Sustainable Cities and Communities)	10	1

12 (Responsible Consumption and Production)	11	1
13 (Climate Action)	5	1
15 (Life on Land)	12	2
16 (Peace, Justice and Strong Institution)	12	3
17 (Partnerships for the goals)	19	1

### OBSERVATION

From the above table it is observed that for SDG-6 (Clean Water and Sanitation) 7 targets among total 8 targets have been found to be incorporated in educational practice, for goal 5(Gender Equality), among a total 9 targets,5 targets have been found to be implemented in educational practice. Whereas for goal 7(Affordable and Clean Energy), among total 5 targets, university has focused on achieving 2 targets representing a commitment to affordable energy. From the above table it is clear that for Goal 3 (Good Health and Well Being), Incorporation of 4 targets among 13 targets given by the UN, has been integrated into the curriculum. It is also observed that for Goal 9(Industry, Innovation, and Infrastructure) the emphasis lies on attaining 3 targets out of total 8 targets.

### INTERPRETATION

From the above table it can be interpreted that along with the successful attempts to practice goals 3,5,6,7,9 (Good Health and well-being, Gender Equality, Clean Water and Sanitation, Affordable and Clean Energy, Industry, Innovation, and Infrastructure) respectively, goals 10,11,12,17(Reduced Inequalities, Sustainable Cities and Communities, Responsible Consumption and Production, Partnerships for the goals) respectively needs to be catered and maximum attempts should be made for sustainable development through educational practices. There has been minimal incorporation of educational practice towards goals 1,2,4,8,13,14,15,16 (No Poverty, Zero Hunger, Quality Education, Decent work and economic growth, climate action, life below water, life on land, Peace, Justice, and Strong Institution respectively), university should cater maximum practices for holistic development of institution with respect to sustainability.

**Graphical Representation**

**Figure 1: Total no. of SDG targets and SDG targets in Educational Practices by Shivaji University, Kolhapur**



**Table. 2: Educational Practices practiced by Shivaji University Sustainable Development Goals**

Sustainable Development Goals	% of Educational Practices
6 - Clean Water and Sanitation	87.5
5 - Gender Equality	55.55
7 - Affordable and Clean Energy	40.00
3 - Good Health and Well Being	38.46
9 - Industry, Innovation and Infrastructure	37.5

**OBSERVATION**

From the above table it is observed that the university has prioritized educational practices related to clean water and Sanitation with an impressive 87.5 % focus suggesting a strong commitment in addressing water and sanitation issues. Whereas a moderate emphasis on Gender Equality with a 55.55% has been noticed. With slightly lower percentages of 40.00 % & 38.46% in Affordable & clean energy and Good Health & Well-being respectively paves way for the educational practices to be included for sustainable development. About 37.5% educational practices in Industry, Innovation and Infrastructure suggests that there could be potential for further integration for sustainability.

**INTERPRETATION**

From the data in the above table, it can be interpreted that the university has a high percentage (87.5%) of educational practices focused on Clean Water and Sanitation, followed by a moderate percentage (55.55%) of educational practices related to Gender Equality. A significant but relatively lower percentage (40.00%) of educational practices for Affordable and Clean Energy was identified. From the above table it can be interpreted that minimum focus among the highest 5 SDGs is given on Good Health and well-being (38.46%) & Industry, Innovation, and Infrastructure (37.5%).

**Graphical Representation**

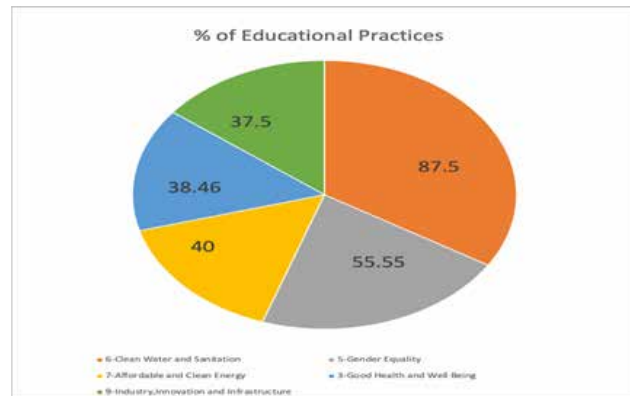

**Figure 2: Educational Practices practiced by Shivaji University Sustainable Development Goals**

**Findings**

The study reveals that there is significant progress in implementing Sustainable Development Goals (SDGs) through the educational practices, particularly in goals 3,5,6,7 and 9. Significantly targets related to Clean Water and Sanitation, Gender Equality, Affordable and Clean Energy, Health and Well-being, and Industry, Innovation and Infrastructure have been addressed with varying degrees of achievement.

The study also reveals that for Goal 3 (Good Health and Well Being) practices like awareness programs on Sexual Offences Act, PCPNDT, HIV-AIDS Prevention are being conducted in educational practices. Incorporation of 4 targets (3.2, 3.3, 3.4, 3.5, 3.9) among 13 targets given by UN, through Physical Education which has been integrated into the curriculum. The highlight was EAT RIGHT MILLET MELA to promote

millets awareness conducted by university. For goal 5 (Gender Equality), targets 5.1, 5.3, 5.5, 5.b, 5.c among a total 9 targets are being implemented through 16 workshops under skill development programs, 4 seminars, certificate courses on women empowerment, rights, sensitization of gender, the campaign against child marriages under NSS scheme. Significant steps have been taken by implementing Gender Studies (LGBT) in the curriculum along with the curriculum of M. A.

For SDG-6 (Clean Water and Sanitation) 7 targets (6.1, 6.3, 6.4, 6.5, 6.6, 6.a, 6.b) among total 8 targets through Installation of R.O. plant and 9000 L Biodigester, 4 Sewage treatment plants treating 210000 L/day water. Rainwater harvesting system, water conservation through drought-tolerant plants, preservation of the water-related ecosystem includes 2 lakes, 8 wells, and 3 farm ponds. In pursuit of goal 7 (Affordable and Clean Energy), among total 5 targets, university have focused on achieving targets 7.2 and 7.3 representing a commitment to affordable energy. Installation of Solar power plants, use of energy-efficient equipment and lighting, "No vehicle day" policy on campus, promoting use of daylight to reduce energy consumption have been embedded in institutional framework.

The study also reveals that for Goal, 9 (Industry, Innovation, and Infrastructure) there is a concerted effort to infuse its principles into educational practices. The emphasis lies on attaining targets 9.4, 9.5, and 9.b. This underscores a focused attention towards green cover and CO<sub>2</sub> sequestration from campus. A research scheme is being practiced to encourage learners to take up research activities. Establishment of SCIL (Shivaji University Centre for Innovation, Incubation, and Linkages) formation of Section 8 company to promote innovative educational practices, under which approximately 23 pre-incubation startups have taken place.

The study depicts that along with the successful attempts to practice goals 3,5,6,7,9 (Good Health and well-being, Gender Equality, Clean Water and Sanitation, Affordable and Clean Energy, Industry, Innovation, and Infrastructure) respectively, goals 10,11,12,17 (Reduced Inequalities, Sustainable Cities and Communities, Responsible Consumption and Production, Partnerships

for the goals) respectively needs to be catered and maximum attempts should be made for sustainable development through educational practices. There has been minimal incorporation of educational practice towards goals 1,2,4,8,13,14,15,16 (No Poverty, Zero Hunger, Quality Education, Decent work and economic growth, climate action, life below water, life on land, Peace, Justice, and Strong Institution respectively), university should cater maximum practices for holistic development of institution with respect to sustainability.

Whereas the study also reveals that there's need for more focus on goals 1,2,4,8,10,11,12,13,14,15,16 and 17 for achieving holistic sustainability. Strategies like incorporating relevant curriculum, conducting awareness programs, and promoting innovation and partnership are highlighted for further progress.

Through the Interview analysis, the identified challenges in implementing SDG practices that came into light was unavailability of manpower, lack of a committee that looks after and organizes programmes, events and awareness workshops regarding sustainability. The study also found that due to the lack of the progress report of Educational Practices of Shivaji University, the progress towards sustainability could not be analysed. Hence the strategies could not be refined and evaluated for maximizing the SDG educational practices in attaining the targets given by the UN.

## CONCLUSION

The study concludes the Shivaji University's dedication to the Sustainable Development Goals (SDGs). The study highlights its focus on varying levels of progress for each SDG, with some goals showing more accomplished SDG targets concerning educational practices than others. Goals 3,5,6,7,9 (Good Health and Well-being, Gender Equality, Clean Water and Sanitation, Affordable and Clean Energy, Industry, Innovation, and Infrastructure) respectively are identified as having advanced significantly in the action plan. Goals 10,11,12,17 (Reduced Inequalities, Sustainable Cities and Communities, Responsible Consumption and Production, Partnerships for the goals) respectively need to be catered and attempts should be made for attaining sustainable development through educational practices.

The study offers valuable insights into the areas of strength and improvement of educational practices towards contribution in sustainable development. The study also forecasts the need for a comprehensive approach across all SDGs and to refine strategies and serve as a valuable reference in contributing further to global sustainable development Goals.

## REFERENCES

1. A. Ashida (2023). The Role of Higher Education in Achieving the Sustainable Development Goals. In S. Urata et al. (Eds.), Sustainable Development Disciplines for Humanity, Sustainable Development Goals Series (p71). [https://doi.org/10.1007/978-981-19-4859-6\\_5](https://doi.org/10.1007/978-981-19-4859-6_5)
2. McCowan, T. (2021). Higher education and the Sustainable Development Goals. *Higher Education*, 81(1), 1–8 <https://doi.org/10.1007/s10734-020-00652>.
3. Ataya, N., & Fadlallah, R. (2018). Changing roles of universities in the era of SDGs: Rising up to the global challenge through institutionalizing partnerships with government and communities. *Health Research Policy and Systems*, 16(1), 38. <https://doi.org/10.1186/s12961-018-0318-9>.
4. International Institute for Higher Education in Latin America and the Caribbean (IESALC). (2022, April 19). How does your institution contribute to the SDGs? <https://www.iesalc.unesco.org/en/2022/04/19/how-does-your-institution-contribute-to-the-sdgs/>
5. Leal Filho, W., Salvia, A. L., & Eustachio, J. H. P. P. (2023). An overview of the engagement of higher education institutions in the implementation of the UN Sustainable Development Goals. *Journal of Cleaner Production*, 386, 135694. <https://doi.org/10.1016/j.jclepro.2022.135694>.
6. Mitter, Radhika, "The Sustainable Development Goals: Promoting Education for Utility or Transformation?" (2016). International Development, Community and Environment (IDCE). 15. [https://commons.clarku.edu/idce\\_masters\\_papers/1](https://commons.clarku.edu/idce_masters_papers/1).
7. PACT 2030, SDG HANDBOOK for Indian Higher Education.
8. Spengler, J. D. (2019). Universities as the Engine of Transformational Sustainability Toward Delivering the Sustainable Development Goals: "Living Labs" for Sustainability. *Sustainable Development Goals*, 1343.
9. WHO Sustainable Development Goals. Retrieved from <https://www.who.int/europe/about-us/our-work/sustainable-development-goals>.

# A Comparative Study of Activity Based Learning (ABL) and Traditional Teaching Method

**Devdas Appasaheb Kare**

Research Student  
Education Department  
Shivaji University  
Kolhapur, Maharashtra  
✉ karedevdas@gmail.com

**Keshav Rambhao More**

Associate Professor  
Azad College of Education  
Satara, Maharashtra  
✉ krmoresatara@gmail.com

## ABSTRACT

It was an initiative of the Government of Maharashtra to implement action-based study programs to increase the learning ability of students in schools from the perspective of 'learning through action' and to provide students with opportunities to provide quality education through tools such as ladders, milestones, learning plates, and also to promote the concept of action-based learning and teaching in every school. With the implementation of this government initiative in many districts, many schools are ABL. But this experiment has been done only in primary schools. The effectiveness of this method has been studied by creating action-based study materials for the subject of history at the secondary level.

The draft Education Policy 2020 also recommends emphasis on action based learning. That is why the researcher A.B.L. The present research paper has been presented for this international conference by conducting a comparative study of the effectiveness of an innovative, cooperative student-centered teaching-learning method for teachers and students based on this epistemology.

**KEYWORDS** : Ladder, Milestone, Learning plate, A.B.L. method.

## INTRODUCTION

The student is at the center of the education process and new teaching and learning methods are constantly sought for his overall development. The research is based on cognitive constructivist approach to creative learning (ABL). According to the 'Action Based Learning Method' developed in 1944 by David Ausubel, an educationist, J. Krishnamurthy's Rishi Valley School first adopted this method. Then Pune, Thane etc. in Maharashtra. It was implemented in experimental form in the districts.

Materials required for action based learning method:-

- 1) Ladder: - Ladder is the annual planning of the subject.
- 2) Milestones: - Milestones are defined stages of study.
- 3) Learning Plates: - Elements, sub-elements, lesson points, pictures, activities etc. of the subject to complete

a milestone. The device arranged is called Kritikard or Learning Plate.

- 4) Work done register :- Work done register is used to record the daily study of students.

Nature of action based learning method in the present research :-

Present research is based on the history subject of class 9th. First, the annual syllabus of History has been converted into Milestone. Based on it, a Ladder is a study ladder. Action Based Learning plates are created to meet a milestone. To complete a learning plate, the following four phases of classroom teaching are defined as- Teacher guidance phase, Peer study phase, Self-study phase and Evaluation phase. Like a game of snake ladder, the study starts with the first milestone. Study plates are prepared by using different symbols and colors according to class and subject so that students



can understand which milestone they are completing and also which study plate has been completed. saffron color is chosen for Class IX and Vehicles is the symbol chosen for History subject. Students complete each milestone by completing daily activities according to the learning plate. Thus completing all the milestones one reaches the final rung of the ladder.

In the present research, as mentioned above, one of the components of class 9 history subject is determined as a milestone. A total of 10 milestones have been set accordingly. Among them, „Science and Technology“ has been selected for the milestone for this research.

### Statement of the problem

“A Comparative Study of Activity Based Learning (ABL) and Traditional Teaching Methods”.

### Objectives of the Research

1. To development of Activity Based Learning material for class IX History subject.
2. To implementation of Action Based Learning Materials for Class IX History.
3. To conduct a comparative study of A.B.L. and traditional teaching methods.

### Hypothesis

Class IX History subject can be taught according to Activity Based Learning method.

### Limitation of the study

1. The present research is limited to Nutan English School, Tisangi, Ratnagiri District.
2. The findings of the present research are limited to students of class IX.
3. The present research is limited to the History subject of Class IX.
4. Present research is limited to the academic year 2023-24.

### Research Hypothesis

Using Activity Based Learning method for Class IX History makes a significant difference in student achievement.

### Null Hypothesis

There is no significant difference in the achievement of the students in the experimental and control groups when the study of Class IX History is done using the Activity Based Learning method.

### Research Variables

Independent Variable: - In this research Activity Based Learning material is independent variable.

Dependent Variable: - In the present research the acquisition of marks obtained by the students in the achievement test is the dependent variable.

Controlled Variables: - Same age, mixed group of boys and girls, achievement test are controlled variables in the present research.

## RESEARCH METHODOLOGY

### Method of Research

The researcher has used Experimental method for the present research.

### Sample Selection

For the present research, 30 students of Class IX of Nutan English School, Tisangi, Ratnagiri District, Maharashtra were selected using Purposive sampling method. 15 students were divided into Control group and 15 students into Experimental group, taking care to ensure equality in all aspects.

### Tools of Data Collection

In the present research the researcher has used a 20 marks Achievement test developed by the researcher.

### Data Analysis and Interpretation

Statistical techniques such as Mean, Standard Deviation, „t' test have been used for the numerical analysis of the data obtained for the present research.

Comparative Study of A.B.L. Method and Traditional Teaching Method:-

In the present research, an Activity Based Learning material for Class IX History was developed for a milestone of Class IX 'Science and Technology'. 11 learning plates were created to achieve these milestones. Then the Experimental group teaching was done using

A.B.L. materials and A.B.L. method. The control group was taught same content through traditional Explanatory method. After the experiment, both groups were given an Achievement test. Through the score obtained in the test, the Mean, Standard Deviation and „t“ Test are analyzed as follows.

**Table 1: Significance of difference between Control group and Experimental group acquisition test scores**

Variables	Student	Mean	S. D.	't' Test Value	Accept / Reject the Null Hypot-hesis
Control group	15	10.93	2.09	4.926	Rejected
Experimental group	15	14.93	1.79		

### Observation

- 1) From the above table it can be seen that the Mean score obtained in the achievement test of the students in the Control group is 10.93 and the Standard Deviation is 2.09; Meanwhile, the Mean score obtained in the achievement test of the students in the Experimental group is 14.93 and the Standard Deviation is 1.79.
- 2) The „t“ value of scores obtained in achievement test of Control group and Experimental group is 4.926. The value of 't' table is 2.048 at significance level of 0.05 and 2.763 at significance level of 0.01 when the coefficient of independence is 28.

### Interpretation

From the above table it can be seen that the 't' value of Achievement Test score of Control group and Experimental group is 4.926 from the 't' Table when the level of independence is 28 more than the 't' value of 2.048 at significance level of 0.05. It is also more than the „t“ value of 2.763 at 0.01 significance level.

Therefore the null hypothesis is discarded at the significance level. That is, if the study of Class IX history is done in an Activity Based learning method, there is a significant difference in the achievement of the students in the Experimental and Controlled groups.

### Findings

- 1) Activity Based Learning (ABL) method is more effective as compared to traditional teaching method.
- 2) Activity Based Learning (ABL) teaching results in better academic achievement of students as compared to conventional methods.

### CONCLUSION

Activity Based Learning (ABL) method is more effective than any other conventional methods for teaching Social Science subject. In academic Education if used A.B.L. materials like ladder, milestone, learning plate etc. prepared and used in classroom teaching, students' studies will be more effective. A habit of self-study will be required. Students will try to solve the problem. It will help to increase the taste of study and self-study among the students. Students can learn at their own pace. The objective of the teaching subject can be achieved through A.B.L.

### REFERENCES

1. Best, J. W., Kahn, J. V. (2009). Research in Education, (10th ed.) New Delhi: Pearson Prentice Hall.
2. Chaudhary, K. V. (February 2019). A study of skill development in upper primary level students through integrated art teaching and creative teaching methods. Arhat Multidisciplinary International Education Research Journal, 6.236. 103-108.
3. Jagtap, H. N. (1999). Innovations in Education, Pune: Nutan Punlication.
4. Jagtap, H. N., Yevle, N. And Salunkhe, T. (2017). New thoughts in education, Pune: Suvichar Publication Mandal.
5. Bhintade, V. R. (1987). Educational Research Methods, Pune : Nutan Prakashan.
6. Sohni, S. K. (1993). Educational Handbook, Pune : Hindustan Publications.
7. Marathi Encyclopaedia. (April 2022). Learning and Teaching Methods, OnlineWebsite: <https://www.schoolington.com/doctor-ambekar-yanche-shaixanik-kary/>

# Paradigm Shift in the Role of Teacher as a Leader

**Sarika. S. Patil**

Assistant Professor  
Department of Education  
Shivaji University  
Kolhapur, Maharashtra  
✉ sarikashravani@gmail.com

**Pratibha S Patankar**

Professor and Head  
Department of Education  
Shivaji University  
Kolhapur, Maharashtra  
✉ pratibhaspatankar@gmail.com

**The only safe ship in a storm is leadership. —Faye Wattleton**

## ABSTRACT

Education is not only the act or process of imparting or acquiring general knowledge, developing the powers of reasoning and judgment, and generally preparing oneself or others intellectually for a mature life. Education is not how well you can read and write but whether you can communicate with and understand the world around you. A good education not only teaches you skills but also helps to broaden your horizons, gain a better perspective, and teach you to think for yourself.

Leadership is about serving and empowering others to lead themselves, celebrating differences (gender, ethnicity, experiences, perspectives and ideas), and connecting, and questioning the status quo. As organizational learning or collective teacher effectiveness, it is an important intervention between leadership and teacher performance and subsequently improved student outcomes. Teachers are arch for learning and fundamentals that prepare students to face the world, with all the ability and skills acquired from the education acquired from childhood till college and adapted to the change, and their success depends on knowledge as well as attitudes and behaviors.

**KEYWORDS** : *Education, Leadership, Teachers, Learning.*

## INTRODUCTION

Guru Brahma Guru Vishnu

Guru Devo Maheshwaraha

GuruSaakshat Para BrahmaTasmai

Sree Gurave Namaha

"The teacher is the creator, the teacher is the preserver."

This verse highlights the importance of the teacher or guru in guiding and shaping the lives of their students. It emphasizes the reverence and respect for teachers in Hindu culture.

India is a land of culture, traditions, and knowledge. From the oldest scriptures, the Vedas to the most resplendent pre-colonized books, Indian Knowledge has been prevalent for centuries. Indian knowledge has its roots in philosophical, spiritual, scientific, and artistic approaches, which are deeply entrenched in

the culture and have had an immense influence on the development of various disciplines such as literature, art, aesthetics, mathematics, philosophy, and science. The Indian Knowledge of education had a significant impact not only on India but on the world at large. It has given rise to many notable scholars philosophers and spiritual leaders who have contributed to various fields of knowledge. These scholars, philosophers, and spiritual leaders were called "Gurus". As time passed the gurus were called as teachers and then mentors, guides, facilitators. Education is an element of human evolution.

Education is not only the act or process of imparting or acquiring general knowledge, developing the powers of reasoning and judgment, and generally preparing oneself or others intellectually for a mature life. Education is not how well you can read and write but whether you can communicate with and understand the

world around you. A good education not only teaches you skills but also helps to broaden your horizons, gain a better perspective, and teach you to think for yourself. So, learning is acquired before birth(womb) and after birth till death so to make learning easy the help we get is first from the mother (family) and then comes the teacher with the help of the teacher learning becomes easy and they help to encourage thinking outside the box and experimenting with new ideas. Life on the whole is not that easy everyone faces problems in their professional as well as personal lives. In such situations, their ability to make rational and informal decisions reflects how educated and self-aware they are. So, by education, we get the capacity and develop critical skills like decision-making, mental stability, problem-solving, logical thinking, etc. Education integrates the person in society by teaching them cultural, and religious values and norms. It forges with the requisite skills to become fruitful members of society. Today's education system is designed for the atomized individual serving the industrialized world. It is not aimed at bringing to blossom the student's true potential. It creates self-centred job-seeking individuals who are focused on making a living. How can 'making a living' be the highest aspiration of anyone? We are capable of much more, but education limits us.

Teachers are arch for learning and fundamentals that prepare students to face the world, with all the ability and skills acquired from the education acquired from childhood till college and adapted to the change, and their success depends on knowledge as well as attitudes and behaviors. In reality, to stay with the flow the teachers need to constantly adopt new skills and knowledge, technology makes it possible to get a more frequent and large-scale approach to the quality of professional development of teachers, and the extent of student success is primarily determined by teacher competence, sensitivity, and teacher motivation. This helps students achieve success in life.

Teacher leaders are an important capital to the principal, fellow teachers, and the school as a whole. Reimagining what school leadership looks like can have a positive impact on school climate, they guide in deciding a proper solution to more people than the principal and support the principal's efforts. Competent teachers can

retain good teachers from leaving schools or Catholic schools which is seen in common. Teachers who feel empowered feel valued, and this positive attitude contributes to positive classrooms and schools. Teacher leaders directly and indirectly lead in their schools. But when a process, plan, or system is created to transparently demonstrate their leadership, a positive school culture can be sustained. To meet the increased, multiple expectations from schools now, as well as to engage teachers, schools must become learning institutions, consciously and continuously pursuing quality improvement. In learning institutions, new kinds of relationships between students, teachers, and leaders are based on reasonably common characteristics that include a trusting and collaborative environment, a shared and monitored mission, initiative and risk-taking, and ongoing, relevant professionalism. Development School leaders were shown to include factors such as teacher satisfaction, school effectiveness, improvement, competence, teacher leadership, distributive leadership, organizational learning, and development as key. These factors correlate for teacher recruitment, development, and retention. School leaders can have great influence over these school-level factors as well as help buffer against mounting extreme and sometimes contradictory external pressures. A skilled and supported leadership team in schools can help foster a sense of ownership and purpose in the way teachers approach their jobs. Providing teachers with professional autonomy will increase the attractiveness of the profession as a career choice and improve the quality of classroom teaching. Teachers who work together in meaningful and purposeful ways are more likely to stay in the profession because they feel valued and supported in their work. Research indicates that although decentralization has occurred from the system to the school level. So, there is a growing understanding that leadership in school communities is embedded in a variety of organizational contexts, not centrally located in one person or office. The real challenge facing many schools is no longer how to improve, but more importantly how to sustain improvement and retainment of teachers. Sustainability will depend on the school's internal capacity to sustain and support developmental activities, and sustainable improvement requires the leadership capacity of the many rather than the few.

### Role of Teacher as Leaders

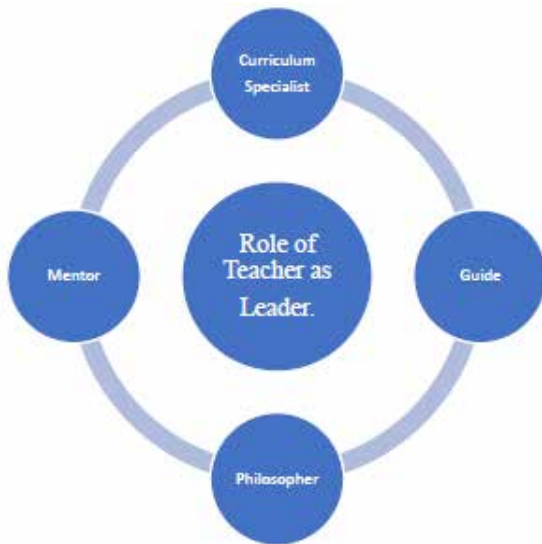

Education expand what counts for effective learning beyond academic achievement to include the way school leaders measure student outcomes—student engagement, self-concept of participation, and community social capital. The nature of work in post-industrial societies is changing significantly, and this change affects the role of educational leaders. Understanding roles and the nature of preparation for them is essential to understanding how work is being defined and organized in the 21st century. In OECD member countries, "school systems and individual schools are experimenting with new approaches to management that seek to make schools fit for the 21st century."

Lui and Kruse (1995) have shown the important role of school-level leadership in the development of professional communities. Teacher morale, efficacy, working conditions, and professional autonomy have all been shown to be important to teachers' emotional lives. (Hargreaves, 2000) "There is no doubt that teachers themselves prefer principals who are honest, communicative, involved, collegial informal, supportive and demanding and reasonable in their expectations with a clear vision for the school – principals who work 'with'. 'through'."

Leadership is about serving and empowering others to lead themselves, celebrating differences (gender, ethnicity, experiences, perspectives and

ideas), and connecting, and questioning the status quo. As organizational learning or collective teacher effectiveness, it is an important intervention between leadership and teacher performance and subsequently improved student outcomes, supporting the development of OL in schools should be an early priority. More attention should be paid to the context in which school leaders operate, particularly concerning school size. Recruitment of School Heads. Review whether accountability measures are reducing the autonomy of teachers and school leaders. Ensure that school leadership is about leadership, not management. Encourage more teachers to extend their work as teachers beyond the classroom to the whole school. Important here are the issues of recruitment and retention in teaching and middle management. Develop a comprehensive succession framework for the management of academic leadership (including recruitment, development, and retention) – Succession planning must be more than just changing jobs in time. To make an informed career decision, good enough applicants who are interested in the job need to be familiar enough (ie, make sure there are opportunities to become familiar with the role). Monitor the numbers seeking middle management positions and key training and respond if the numbers seem hopeless. A school leader's position requires not only job satisfaction but also being perceived as providing job satisfaction to others. More work needs to be done to make school leadership an attractive and 'doable' task for all those working in or aspiring to such positions, including seeing the impact of workload. Strategies include: Providing early leadership experiences for young teachers. Examples of good practices in managing workloads and disseminating school structure models and processes that make effective use of administrative and other staff, use appropriate task delegation. demystifying the principal's role, particularly administrative and financial roles and responsibilities; Additionally, motivating principals to express and exhibit a sense of fulfillment in their roles. Instead of discouraging leadership aspirants, selection procedures can promote and encourage them, such as by providing several career routes. being founded on the values of justice and quality, and being simplified to minimize the amount of effort, time, and stress involved. Create a professional development program



after that to ensure a successful selection procedure. Put in place recruitment and placement initiatives to boost the proportion of minority students enrolled in programs for educational leadership. Draw attention to leadership positions in "tough situations" inside schools. Retention: Developing school leaders professionally, holding off on training until school leadership jobs are secured, and viewing the induction process as a crucial and unique learning stage in a school leader's career. Aspiring school leaders should have access to developmental programs. abilities in combining personal, academic, and external values and attitudes; Emphasis on motivating participants to create plans for juggling work and other commitments; greater chances for team members to grow professionally together; one way to do this would be by the appointment of a governing body chair; Increase the amount of room available in all school leader professional development programs: exemplary practices of leadership values in action: expanding beyond upkeep and management to relationships and school improvement/learning outcomes; how to define, prioritize, develop plans, and measure against all leadership actions; For all stages of a school leader's career, develop and implement. programs for wives and families that provide help during relocation, both locally and regionally. initiatives aimed at fostering leadership more fairly throughout educational institutions.

In conclusion, the present research paper has delved into the pivotal role of teachers as leaders in the ever-evolving landscape of education. As society undergoes rapid changes, teachers must not merely be conveyors of knowledge but proactive leaders, guiding students through the complexities of a dynamic world. the evolving role of teachers as leaders is not only essential for student success but also pivotal in shaping a society that thrives on knowledge, adaptability, and inclusivity. As we navigate the complexities of the changing world, the leadership role of teachers remains central to the cultivation of informed, empowered, and socially responsible global citizens.

## REFERENCES

1. Barth, R. (1999). *The teacher leader*. Providence, RI: The Rhode Island Foundation.
2. Barth, R. (2001). *Teacher leader*. *Phi Delta Kappan*, 82(6), 443-449.
3. Bass, B. (2000). The future of leadership in learning organizations. *Journal of Leadership Studies*, 7(3), 18–38.
4. Beane, J. (1998). Reclaiming a democratic purpose for education. *Educational Leadership*, 56(2), 8-11.
5. Beaudin, D., Thompson, J., & Jacobson, S. (2002). The administrator paradox: More certified, fewer apply. Paper for American Educational Research Association annual conference, New Orleans.
6. Begley, P. (2003). What school leaders should know and be able to do. A paper presented at the International Congress for School Effectiveness and Improvement, January, Sydney.
7. Caldwell, B. (2002). A blueprint for successful leadership in an era of globalization in learning: Implications for preparation, licensure, selection, evaluation, and professional development. In Wen-liuh Lin (ed). *Proceedings of international conference on school leaders preparation, licensure/certification, selection, evaluation, and professional development*. Taipei: National Taipei Teachers College Principals' Centre.
8. Hallinger, P. (2002). The changing landscape of educational leadership development: A global perspective. Lisse: Swets & Zeitlinger.
9. MacBeath, J. (ed.). (1998). *Effective school leadership: Responding to change*. London: Paul Chapman.
10. Rodriguez, A. B. *Embracing Diversity: The Role of Teachers in a Globalized World*. In S. M. Anderson (Ed.), *Leadership in Education* (pp. 76-92). Springer.
11. Thompson, L. K. *Empowering Educators: A Guide to Teacher Leadership*. Academic Press.

# The Effectiveness of Counseling about Water Literacy on the Students in Class 10<sup>th</sup> from Ratnagiri Tehsil

**Sarjerao Pandurang Chavan**

Associate Professor

Government College of Education

Ratnagiri, Maharashtra

✉ chavansp2017@gmail.com

## INTRODUCTION

The Planning Commission of India in its ninth Five Year Plan Scheme paid special attention to the environment. It insisted that the sustainable development of country should not be combined with the decline of environment. It also urged that it is important to protect environment, stop activities that cause water pollution and to save water for future generation. As human beings we need to think of the next generation and use available water sparingly. Now a day water is used in a large quantity in industries, horticulture area, farming, housing society etc. Since water is life, it is everyone's responsibility to have proper knowledge of how to use water economically to avoid upcoming scarcity of water. One percent of total water available on the earth is used for living things. Today we are facing sever problem of water pollution and water scarcity. There are many factors responsible for water pollution. Rapid growth in population, huge development due to science and technology, disasters, human greed are some of the factors responsible for water pollution. If you want to put an end to these factors and protect our planet from being destroyed, we need to save the water on the earth. The steps towards water literacy is one of the measures that can create awareness about the proper use of water and restrict the people from being careless in use of water. We all need to ensure that our occupations and daily activities are not harmful to nature but conducive to its development. A human being needs to make appropriate change in his lifestyle if it causes decline of environment.

### Need and Importance of the Research

About 70% of the earth's total surface is covered with water. The distribution of this water is as follows:

97% - sea water,

2% - water found in the form of ice

1% - freshwater (used for the purpose of drinking)

It is clear from the above statistic that the storage of drinking water is very low on the earth. However the use of fresh water is increasing day by day due to rapidly growing population, industries, farming, horticulture, housing society, constructions etc. In other words the sources are limited but the use is vast. That is why it is necessary to be economic in the use of water. It is usually found that in some places like schools, colleges, offices, public places and commercial establishments etc. water taps keep running or they are not closed properly due to which water keeps flowing all the time. This is really the waste of water that leads finally to the scarcity of water in future. No doubt water level under the ground is decreasing day by day because of excessive use of it. Moreover there are some other reasons responsible for the decreasing level of water under the ground. Soil erosion, accumulation of soil in water bodies, unnecessary cutting of trees, are some of them. Since decreasing level of water under the ground is a major concern today, we need to find out innovative measures through which water level can be increased and we will be able to overcome this sever water crisis. Harvesting of rainwater is one of the measures which can be used both in urban and rural areas to tackle with the problem of water scarcity especially occurs in summer.

The problem of water scarcity is the gap between demand and supply of water. If you want to solve this problem we are required to bridge this space between demand and supply. The technique of effective water management will help to solve this problem to some

extent. Again the government should open special drive that incorporates several activities to create awareness about water conservation and water literacy in the people of urban and rural area.

If the students in schools and colleges are given information about water conservation it will contribute to the conservation of water sources. The counseling given on water literacy may help to keep the rivers from being polluted.

The researcher has undertaken this research work from the above perspectives.

### Objectives of the research

The researcher has carried out this study along with following objectives.

- 1) To create awareness about the water literacy in 10th class students.
- 2) To formulate joyful activities through which counseling can be done.
- 3) To put the activities into action at school.
- 4) To study the effectiveness of counseling through activities on the students.

### Operational definitions of key concepts in the Study

- 1) Water literacy -

The knowledge of using water appropriately and putting an end to the activities

that cause waste of water.

- 2) Counseling -

To give professional advice and help somebody to overcome problem.

- 3) Effectiveness:

The degree or level of change in the existing behavior or mindset.

### Hypothesis of the Study

There is a remarkable gain in the knowledge of water literacy of the students after they are provided with counseling.

### Scope and Limitations of the Study

- 1) The present study is related to the 10<sup>th</sup> class students

in A.A. Desai High School, Hathakhamba, Ratnagiri.

- 2) This study is limited to the students from Marathi medium school

- 3) This study is limited for the academic year 2023 - 24

Sampling:-

The researcher has used lottery technique from Simple Random Sampling method for selecting the sample. 142 students are studying in class 10th for the academic year 2023-24.

Of these 40 students including 20 girls and 20 boys are selected as sample. An experimental group and control group were formed by the researcher. Each group contained equal number of students.

### Research Method

The researcher, in this study has used experimental method along with single group design.

### Tools of the Study

Pre test and Post test were used to collect the data required for study.

### Independence variable

Counselling program of water literacy

### Dependent variable

The level of awareness of water literacy in the students

### Analysis and Interpretation of Data

The researcher has used experimental group and control group in this study. Traditional method was used for control group to introduce water literacy while counseling method was used on experimental group.

The counseling program incorporated following activities-

- 1) word puzzle -

In this activity the students were given puzzles with words related to water literacy.

- 2) Slogans -

Best slogans competition was held in the school.

- 3) Impromptu Speech -

In this activity the students were asked to pick up the

chits on which water related topics were written and then they were asked to speak at least ten lines on the topics.

4) Group Argument-

In this activity, different groups were formed by the researcher and innovative topics related to water literacy were given to them. They were asked to discuss on these topics from different aspects.

Testing of the Hypothesis:-

Group	Students (N)	Mean (M)	S. D.	Obtained 't' value	Assumed 't' value
Experimental Group	20	42.38	8.46	6.44	1.98
Control Group	20	<b>36.82</b>	5.32		

From the above table it is learnt that there is significant increase in the acquisition as the obtained 't' value is 6.44 which is greater than assumed 't' value 1.98 on the environment factor about the water literacy of students with the help of counseling, so the research hypothesis is valid at 0.01 level.

FINDINGS

1) The awareness about water literacy has been increased significantly in 10th class students after providing counseling to them.

- 2) It has been noticed that the level of information about water literacy in the students increased significantly after counseling.
- 3) The effectiveness of counseling is greater than the effectiveness of traditional methods on the students.

RECOMMENDATIONS

- 1) A number of lectures should be organized at school level regarding environment and its protection.
- 2) Different activities should be formed and implemented in connection with water conservation.
- 3) Students should be given real experience through field visits.
- 4) Maximum teaching material should be used by the teachers during lessons related to Environment.

REFERENCES

- 1. Bhintade, V. R. ( 1999 ), Education Research Method, Nutan Publication, Pune.
- 2. Bhandarkar, K. L. ( 2002 ), Environment Education, Nityanutan Publication, Pune.
- 3. Best J. W.( 2005 ),Research in Education, Prentice and India Pvt. Ltd. New Delhi.
- 4. Nanavare S. N. ( 2005 ), Environmental Awareness, Nirali Publication, Pune.
- 5. Mule R. S. and Umathe V. T. ( 1987 ), Fundamental Principles of Research, Vidya Publication, Nagpur.
- 6. Pandit, B. B. (2002 ), Education Research Method, Nutan Publication, Pune.

# A Comparative Study of Fourth Industrial Revolution and Fifth Industrial Revolution: Educational Perspective

Geetawali Joshi

✉ geetajoshi70@gmail.com

P. S. Patankar

✉ pratibhaspatankar@gmail.com

## ABSTRACT

With Education perspective, this paper compares the 4IR and 5IR. It focuses on man-machine collaborations. However, will enhance well-being of present society across the world, If the electronic and biophysical ways mixed together. This study shows a new pathway for the progress of Fifth Industrial Revolution and how Education system should be redesigned. 4IR has considered the integration of specialized invention and institutional invention as the crucial structure blocks, similar that the commerce of mortal and technology are applied to increase functional effectiveness, including tutoring while enhancing socioeconomic and environmental performances. This shift focuses on employing technology made possible through IR4.0 to make mortal life more comfortable and sustainable, as well as resolving societal challenges similar as issues related to a large aging society, energy and environmental sustainability.

**KEYWORDS** : *Fifth Industrial Revolution Well-being, Human-machine collaboration, Human-technology collaboration retail revolution, Service revolution, Fourth Industrial Revolution Sustainable goals Technology.*

## INTRODUCTION

Crucial technologies of the Fifth Industrial Revolution Important generalities in the Fifth Industrial Revolution include “man-centeredness” and “sustainability.” Under the mortal-centered conception of the Fifth Industrial Revolution, people and machines will work in the same circle. It focuses on technologies that are friendly to the mortal body and the terrain. “Cooperative robots” and “smart cell diligence” are the exemplifications to explain new technologies in the Fifth Industrial Revolution. Industrial robots that work in the same space as humans in a terrain with no walls are called “Collaborative Robots” (Cobots). In addition, the application of safety control software, etc., enables collaboration between people and robots. Hence AI and its operations are veritably important for the society.

The elaboration of these digital technologies similar as smart cell technology and their high-position integration with biotechnology hold the key to the consummation of “sustainable” profitable conditioning that are friendly to people and the terrain in the Fifth Industrial Revolution.

The Industrial revolutions have both positive and negative effects on Education. Due to large manufacturing companies new machineries, new technologies were used it led to the new inventions and changes in the world’s Education system took place.

The firstly it is required to train School teachers on how to work with the new inventions. Secondly it was needed to choose specific professions to fulfil the need of factories. Education become inclusive and free for all; this is also an important effect of industrialization. We have gone through the 4IR and now stepped in to



the 5IR. Hence it is necessary to study what is new in this phase of revolution for Education. Because of Industrial Revolutions it is possible to create highly qualified experts to invent new technologies dealt with specific fields. This paper compares the two Industrial Revolutions and tries to find out best solutions for Education.

Fifth Industrial Revolution, works on deeper and broader generalities to resolve the issues of the Fourth Industrial Revolution. For illustration, the European Commission has blazoned "Industry5.0," which aims for an ideal assiduity grounded on the generalities of "sustainability," "man-centeredness," and "adaptability," while Germany has blazoned the "2030 Vision for Assiduity4.0" as the policy to follow Assiduity4.0. Fifth Industrial Revolution will involve the development of new structure and the consummation of an "ultra-smart society" through the high-position integration of IT and AI with robotics technology and biotechnology as well as cyberspace (virtual space) with physical space (real space).

## THE FOURTH INDUSTRIAL REVOLUTION

The 4IR till the year 2020 was the beginning of highly disruptive modern technologies, such as the Cloud Computing, Big Data, Artificial Intelligence, Machine Learning, Blockchain, Internet of Things etc. Fast and automated decision-making was made possible during the (4IR) with the help of easily accessible, widespread interconnectivity and real-time data acquisition. With 4IR it was also observed that development of the smart factories took place through a merger of virtual and physical manufacturing systems. The main characteristic of 4IR is innovations in semi-conductor technologies.

IoT transforming into IIoT (Industrial Internet of Things); cloud computing advancing to fog and edge computing; telecom switching from 2G to 3G to 4G and 5G; AI/ML moving to Deep Learning, and more recently to Generative AI/ Large Language Models (LLMs) such as Chat GPT these are the characteristics of 4IR.

The emergence of the gig economy and the beginning of the so-called human cloud, the blockchain technology,

the era of bitcoin started during the 4IR. We can say that the 4IR is the fusion of digital, physical, and biological domains. Other remarkable technologies in the 4IR included the Nano-technology and Quantum Computing.

The 4IR technologies also led to a decision making by the machines instead of the human authority.

## FIFTH INDUSTRIAL REVOLUTION

The Fifth Mechanical Transformation centers on the concepts such as "sustainability," "human-centeredness," and "concern for the environment". Worldwide financial authority is the main point of 5IR, It points to form unused markets for recycle-oriented items, secure and maintainable chemical substances, that are not susceptible to climate alter.

Subsequently it is essential to make mindfulness among understudies approximately reused items, climate changes through their curricula.

The Fifth Industrial Revolution focuses on the concepts such as "sustainability," "human-centeredness," and "concern for the environment". Global economic hegemony is the main aim of Industry 5.0. It aims to create new markets for recycle-oriented products, safe and sustainable chemical substances, that are not susceptible to climate change. Hence it is necessary to create awareness amongst students about recycled products, climate changes through their curricula.

### Characteristics of the Fourth Industrial Revolution

"Industry 4.0 was human-less," says Professor Peter Ralph, Director of the UTS Climate Change Cluster (C3), a leading sustainability research centre. The Fourth Industrial Revolution, successfully made it possible handling complex tasks by learning from work data and making predictions and inferences. Due to the use of AI the industry has successfully increased its ability to carry out mass production of a small variety of goods to a surprising level. We are now familiar to automated systems, online public services which give convenience to our lives.

However, the Fourth Industrial Revolution does not have a human-centered approach that takes human preferences into account which incorporate sustainability that considers the global environment.

The Fourth Industrial Revolution was limited in its ability to meet a wide range of social demands.

**Key technologies of the Fifth Industrial Revolution**

Important concepts in the Fifth Industrial Revolution include “human- centeredness” and “sustainability.” Under the human-centered concept of the Fifth Industrial Revolution, people and machines will work in the same loop. It focuses on technologies that are friendly to the human body and the environment .“Collaborative robots” and “smart cell industries” are the examples to explain new technologies in the Fifth Industrial Revolution. Industrial robots that work in the same space as humans in an environment with no barriers are called “Collaborative Robots” (Cobots). In addition, the utilization of safety control software, etc., enables collaboration between people and robots. Hence AI and its applications are very important for the society. The evolution of these digital technologies such as smart cell technology and their high-level integration with biotechnology hold the key to the realization of “sustainable” economic activities that are friendly to people and the environment in the Fifth Industrial Revolution.

Fifth Industrial Revolution, works on deeper and broader concepts to resolve the issues of the Fourth Industrial Revolution. For example, the European

Commission has announced “Industry 5.0,” which aims for an ideal industry based on the concepts of “sustainability,” “human-centeredness,” and “resilience,” while Germany has announced the “2030 Vision for Industry 4.0” as the policy to follow Industry 4.0. Fifth Industrial Revolution will involve the development of new infrastructure and the realization of an “ultra-smart society” through the high-level integration of IT and AI with robotics technology and biotechnology as well as cyberspace (virtual space) with physical space (real space).

**Characteristics of the Fifth Industrial Revolution**

According to Dunn, “While Assiduity 4.0 speaks to a broad compass of technology- led changes affecting all aspects of mortal society encyclopaedically, the arising conception of Assiduity 5.0 is more hardly focused on effective manufacturing processes, through better

commerce between humans and robots while limiting waste and guarding the terrain.”

It aims to foster harmonious and synergistic collaboration between humans and machines. The 5IR emphasizes upon the well- being of mortal being, the earth Earth and humanity as a whole. It emphasizes the use of technology and imposes precisely designed restrictions to minimize its destructive goods on humans. It gives important for the relinquishment of sustainable and renewable energy coffers. Hence it's needed to work towards the betterment of humankind. rather of IoT that's internet of effects, the 5IR introduces IoB that's internet of Bodies and significant advancements in the bio-tech sphere, smart cells, bio-fuels, gene curatives, and the integration of technology into the mortal body through" bionic addition". Assiduity 5.0 envisions a new mortal- centered society which will balance profitable development and resolving societal and environmental challenges. In the Society 5.0, the emulsion of cyberspace and the physical space plays a pivotal part in chancing results to the being societal and environmental issues technology.

The crucial differences are epitomized in Table 1.

**Table 1. Differences between the 4IR and 5IR**

4IR	5IR
Increased use of technologies	Adding the power of both technology and
Competition of Humans with machines	Humans collaboration with machines
Preferance to the technological progress	Well-being of all of humanity and the
Trust on technology	Earth and Pursuit of gains with a purpose
Allwing for need of technology	Uses of technology An emphasis on the well-being of a society , by pushing the boundaries of technology.

To meet the purpose of 5IR, it’s important to apply sociotechnical proposition maximizing the strengths of both social (e.g. empathy, problem working, creativity, and technology (e.g., speed, effectiveness, robotization) It’s needed now to concentrate on the aspects of humanity, empathy, family care etc. Education will help

in strengthening the relation between technology and humanity.

Education in 4IR and 5IR

**Table 2 Education in 4IR and 5IR**

4IR	5IR
The 4IR informs preceptors to use new tutoring strategies, so they inculcate colourful thinking skills among students.	5IR gives stress on how unborn preceptors, scholars use technology for their literacy terrain, helps to understand the facilitators.
The findings show that 4IR gives better learning environment, helps to understand the facilitators.	5IR gives curriculum for advanced learners.
Education is more accessible, with a range of different knowledge sources.	5IR develops the openings of new jobs

So new exploration is demanded to outline mechanisms and dynamics which will support workers rather than machines.

For sustainable manufacturing the following three directions are useful

- Reduce consumption and increase the impact
- furnishing transparent services rather of mass product
- Use of indirect profitable system

**Role of Education in 5IR**

The use of advanced technologies for people through 5IR helps an workers, and consumers. “scholars should also admit early exposure to the value of critical thinking, wide reading, community history, artistic trades and mortal communication. The hardcore practice of streaming scholars into trades beforehand in the secondary system must give way to what's now called a ‘coincident education’, in which the benefits of an education in both the trades and lores can be stationed by scholars in the selection of new careers that frequently bear this binary exposure”.

Thorpe said it's applicable that there’s a shift in original educational and business practices demanded to achieve these realignments. “ still, these transitions

aren't easy, hence the need to be deliberate cannot be exaggerated. Some immediate way will need to include talented coaches and instructors – new and living – to be automated in the depth of practice and chops training, which harnesses cooperative artificial intelligence”.

Secondly, the study should be done on cooperative AI results to estimate these and promoted as a part of introductory exploration grounded on the result of university training sodalities. There are also training and education difficulties associated with espousing I5.0. directors and work ers, both present and unborn, must retain the capabilities needed by the I5.0. This necessitates new course material in both Vocational Education Training and Higher Education.

So new research is needed to outline mechanisms and dynamics which will support employees rather than machines.

For sustainable manufacturing the following three directions are useful:

- Reduce consumption and increase the impact
- Providing transparent services instead of mass production
- Use of circular economic system

This necessitates new course material in both Vocational Education Training and Higher Education.

**CONCLUSION**

The 5IR, covers the man– machine combined working, so that society will be safe in future. It finds the path for development of mortal – machine collaborations. The 5IR compares the relationship between the retailers and services of consumers to produce a cling between machines and humans.

As we know that humans will play a crucial part in tran substantiating 4.0 systems for the new world, taking the good corridor of robotization and disposing of the bad. 5IR represents a paradigm shift in the way humans and technology interact. It seeks address environmental challenges, and prioritize the well- being of all. The 5IR aims to produce a future where technology serves humanity in a responsible and ethical manner, paving the way for a better world. New inventions and other arising technologies will hopefully be targeted at

achieving a harmonious balance between humans and machines and chancing new ways to save the earth from farther environmental declination.

Education will play an important part in achieving goals of 5IR. The 5IR, gives stress on how humans and technology can stay together.

It's clear that new kinds of jobs will live and bear new chops among workers. So it's the time to shift the Education system encyclopaedically. Thus, the emphasis must be given on mortal chops similar as communication, leadership and abidance, as well as curiosity, appreciation and reading chops.

## REFERENCES

1. <https://article.murata.com/en-sg/article/what-is-the-fifth-industrial-revolution>
2. Ball, Catherine (24 ct. 2022), "How the fifth industrial revolution will impact the future of work", The CEO magazine, accessed at <https://www.theceomagazine.com/business/innovation-technology/fifth-industrial-revolution/>
3. <https://www.studocu.com/ph/document/rizal-technological-university/bs-education/the-fifth-industrial-revolution-essay/23373261>
4. <https://uniarea.com/is-education-ready-for-the-5th-industrial-revolution/> <https://aryunetworks.com/what-will-the-5th-industrial-revolution-look-like/>

# Importance of Integrating SDGs Into the Educational System

**Khandekar Kadambari Ramesh**

Research Scholar

Shivaji University

Kolhapur, Maharashtra

✉ kadambarikhandekar@gamil.com

## INTRODUCTION

Education is seen as a big force; a force that not only contributes to national development, but also sustainable development. It is a key to development, be it social, economic, political or environmental. Education promotes development of knowledge and skills required to achieve sustainable development (SD). It encourages promotion of economic well-being, social equity, democratic values and much more. Education for Sustainable Development (ESD) enables people and citizens to learn as to how to preserve earth resources which are limited in availability. The ESD has the objective of empowering present and future generations to meet their needs using a balanced and integrated approach to the economic, social and environmental dimensions of SD.

Education for sustainable development (ESD) promotes the development of the knowledge, skills, understanding, values and actions required to create a sustainable world, which ensures environmental protection and conservation, promotes social equity and encourages economic sustainability.

## SUSTAINABLE DEVELOPMENT GOALS

The Sustainable Development Goals (SDGs), also known as the Global Goals, were adopted by the United Nations in 2015 as a universal call to action to end poverty, protect the planet, and ensure that by 2030 all people enjoy peace and prosperity.

In 2015, the 193 countries that make up the United Nations (UN) agreed to adopt the 2030 Agenda for Sustainable Development. The historic agenda lays

out 17 Sustainable Development Goals (SDGs) and targets for dignity, peace, and prosperity for the planet and humankind, to be completed by the year 2030. The agenda targets multiple areas for action, such as poverty and sanitation, and plans to build up local economies while addressing people's social needs.

In short, the 17 SDGs are:

Goal 1: No Poverty: End poverty in all its forms everywhere.

Goal 2: Zero Hunger: End hunger, achieve food security and improved nutrition and promote sustainable agriculture.

Goal 3: Good Health and Well-being: Ensure healthy lives and promote well-being for all at all ages.

Goal 4: Quality Education: Ensure inclusive and equitable quality education and promote lifelong learning opportunities for all.

Goal 5: Gender Equality: Achieve gender equality and empower all women and girls.

Goal 6: Clean Water and Sanitation: Ensure availability and sustainable management of water and sanitation for all.

Goal 7: Affordable and Clean Energy: Ensure access to affordable, reliable, sustainable and modern energy for all.

Goal 8: Decent Work and Economic Growth: Promote sustained, inclusive and sustainable economic growth, full and productive employment and decent work for all.



**Goal 9: Industry, Innovation, and Infrastructure:** Build resilient infrastructure, promote inclusive and sustainable industrialization, and foster innovation.

**Goal 10: Reduced Inequality:** Reduce inequality within and among countries.

**Goal 11: Sustainable Cities and Communities:** Make cities and human settlements inclusive, safe, resilient, and sustainable.

**Goal 12: Responsible Consumption and Production:** Ensure sustainable consumption and production patterns.

**Goal 13: Climate Action:** Take urgent action to combat climate change and its impacts.

**Goal 14: Life Below Water:** Conserve and sustainably use the oceans, seas, and marine resources for sustainable development.

**Goal 15: Life on Land:** Protect, restore, and promote sustainable use of terrestrial ecosystems, sustainably manage forests, combat desertification, and halt and reverse land degradation and halt biodiversity loss.

**Goal 16: Peace, Justice, and Strong Institutions:** Promote peaceful and inclusive societies for sustainable development, provide access to justice for all and build effective, accountable, and inclusive institutions at all levels.

**Goal 17: Partnerships to Achieve the Goal:** Strengthen the means of implementation and revitalize the global partnership for sustainable development.

### Importance Of Integrating SDGs Into The Educational System

Integrating the Sustainable Development Goals (SDGs) into the educational system is crucial for several reasons:

**Global Citizenship Education:** By incorporating SDGs into the curriculum, students gain a deeper understanding of global challenges and the interconnectedness of issues such as poverty, inequality, climate change, and environmental degradation. This fosters a sense of global citizenship, encouraging students to think beyond national boundaries and become responsible global citizens.

**Holistic Learning:** SDGs cover a wide range of topics,

including social, economic, and environmental aspects. Integrating them into education allows for a holistic and interdisciplinary approach to learning. Students can develop a comprehensive understanding of complex issues and recognize the interdependencies between different goals.

**Critical Thinking and Problem-Solving Skills:** SDGs provide real-world problems that require critical thinking and problem-solving skills. Integrating them into the educational system helps students develop analytical skills, creativity, and the ability to propose and implement solutions to address complex challenges.

**Values and Ethics:** The SDGs are rooted in principles such as sustainability, equality, and social justice. Integrating these goals into education helps instill values and ethics in students. It promotes a sense of responsibility towards the environment, society, and future generations.

**Preparation for Future Careers:** As the world evolves, there is an increasing demand for individuals who possess a deep understanding of sustainability and global issues. Integrating SDGs into education ensures that students are well-prepared for future careers that require a strong foundation in environmental stewardship, social responsibility, and ethical decision-making.

**Community Engagement and Service Learning:** SDGs often involve community-level actions. Integrating them into the educational system facilitates community engagement and service learning opportunities. Students can apply their knowledge in real-world situations, making a positive impact on their communities and fostering a sense of social responsibility.

**Empowering Students:** Knowledge about the SDGs empowers students to become agents of change. By understanding their role in achieving sustainable development, students are more likely to actively contribute to positive social, economic, and environmental changes in their communities and beyond.

**Global Collaboration:** The SDGs emphasize the importance of global collaboration to address shared challenges. Integrating these goals into education

encourages collaboration among students, educators, and institutions globally, fostering a sense of shared responsibility and a collaborative mindset.

In summary, integrating the SDGs into the educational system is essential for nurturing informed, engaged, and responsible citizens who can contribute to a sustainable and equitable future. It aligns education with the broader global agenda for sustainable development, preparing individuals to tackle the challenges of the 21st century.

## REFERENCES

1. Mule R. V, Umathe V.T (1988) Fundamentals of Sanidhana, Maharashtra University Grants Vanarmati Mandal, Aurangpura, Aurangabad.
2. Best J.W. Kahn J.V. (2008) Research in Education, Prentice Hall of India, New Delhi.
3. <https://egyankosh.ac.in/bitstream/123456789/77376/1/Unit-10.pdf>
4. <https://tsge.edu.in/blog/role-of-education-for-sustainable-development/>
5. <https://www.fao.org/3/CA3121EN/ca3121en.pdf>
6. [https://www.iges.or.jp/en/publication\\_documents/pub/bookchapter/en/4931/05\\_Ch5\\_Achieving\\_the\\_SDGs\\_.pdf](https://www.iges.or.jp/en/publication_documents/pub/bookchapter/en/4931/05_Ch5_Achieving_the_SDGs_.pdf)
7. <https://www.slideshare.net/SheetalTank1/integrating-sustainable-development-goals-sdgs-in-school-education>
8. <https://www.ncbi.nlm.nih.gov/pmc/articles/PMC10071976/>
9. <https://www.linkedin.com/pulse/beneficial-schools-include-sustainable-development-sarbani-das>
10. <https://fardapaper.ir/mohavaha/uploads/2021/12/10-Integrating-Sustainable-Development-Goals.pdf>

# A Study in the Development of An Eco-friendly Action Program for Language Creativity

**Pranita Chandrashekar Teli**

Research Student  
Education Department  
Shivaji University  
Kolhapur, Maharashtra  
✉ pranitateli003@gmail.com

**Keshav Rambhau More**

Assistant Professor  
Azad College of Education  
Satara, Maharashtra  
✉ kmoresatara@gmail.com

## ABSTRACT

Education is developmental change. Education creates a change in human behavior. The learning process in human life starts from birth. Language develops through study. A child acquires the language of the environment in which he is born, grows and lives. Language is a means of consciousness. Students can express their thoughts, feelings through language through writing. For this, formal and informal education helps the child, so it is necessary for the sustainable development of the student. Sustainable development can be achieved through environment.

Environmentally friendly elements have been included in the curriculum. The thinking process of students can be enriched through environmental action programs. A student expresses his thoughts, his own opinions and his behavior also changes. Also the student is able to meet the global challenges of the future era.

**KEYWORDS** : *Awareness, Sustainable development.*

## INTRODUCTION

Education is the transformation that takes place in a person, from birth to death, a person is learning something. Learning is when a person tries to change himself by using the environment. Awakening the latent qualities of students, development of various abilities of students is achieved through education. The formal and non- formal education process of students continues continuously.

A student is not only formed through school education, but every factor around him contributes to his development. Students are connected to nature through animals, birds, plants and animals. The student learns from real life. He acquires knowledge directly from nature. The umbilical cord of nature environment and student is connected from his birth. That is why these subjects have been included in the syllabus.

The curriculum incorporates lifelong development through course components. Care has been taken to

ensure that the student is connected to the environment through the process of perpetual development.

According to psychologists man cannot think because of lack of language. Words are symbols of ideas. Language is not a means of emotional awareness through language a student expresses his feelings. Mother tongue is the best medium of education Language is of unique importance. Educationally, our children should be taught language and literature right from childhood. It is necessary to introduce culture through literature.

Creation means innovation. Creating inspiration in students to write beautiful, independent and original style. Curriculum environment can be useful for students to express their new thoughts, concepts, ideas through writing through their language. Creativity is the independent and free thinking power to think in a different direction. She does not think from a traditional point of view, she finds a new path without going through a certain task. That is creativity. The student travels to

innovation through language and gives concrete shape to his thoughts and ideas.

**Problem Statement**

A study in the development of an eco-friendly action program for language creativity

**Research Objectives**

- 1] Development and Implementation of Environmental Action Program for Creative Development in Class VII Marathi Language.
- 2] To investigate the effectiveness of environmental action program for creative development in Marathi language of class VII

**Hypothesis**

Students have some creative ideas.

**Limitation**

- 1. The present research is limited to the school Nehru Vidyamandir Shindewadi.
- 2. The findings of the presented research are limited to the students of class VII.
- 3. The research presented is limited to the academic year 2023 / 24.

**Importance**

- 1. Students will be happy with their mother tongue by developing interest in language subject.
- 2. Students will be exposed to different types of literature, will develop self attitude along with alternative reading.

**Need**

- 1. The said research adds to the knowledge of language as a subject like language is neglected.
- 2. The extent of Marathi mother tongue needs to be taken into account.
- 3. Students study happily.
- 4. Identify different parts of language.

**Variables in research Depend variables**

Development of program for upper primary level students

**Independent variables**

Creativity of Upper Primary Level Students.

**RESEARCH METHODOLOGY**

**Research Methods**

The researcher has used experimental method for the present research.

**Sample selection**

28 seventh-grade students from Nehru Vidyamandir Shindewadi, Taluka Karveer, District Kolhapur, were chosen for this study utilizing the purposive sample technique. For the pre-and post-test, 28 students have been split up.

**Tools of Information Collection**

In the present research, the researcher has used a 20-point test of researcher creation.

**Analysis and interpretation of information**

Statistical principle of mean, standard deviation, t-test has been used for the numerical analysis of the data obtained for the present research.

**Significance of difference between pre-test and post-test scores**

	Num- bers	Average	Deviation	t-test value	Rejection of the null hypothesis
Pre test	28	7.9	1.68	2.69	Reject
Post test	28	14.9	2.04		

**Analysis of information**

- 1. From the above table it can be seen that the mean score obtained by the students in the pre-test is 7.9. The standard deviation is 1.68. The mean of the marks obtained in the final test is 14.9 and the standard deviation is 2.04.
- 2. The t value of marks obtained in pre-test and post-test is 2.69. 27 From the t table on this degree of independence the value is 1.703 at the significance level of 0.05 and the value is 2.473 at the significance level of 0.01.

**Interpretation**

From the above table it can be seen that the t value of pre test and post test is 2.69 and the degree of independence

from t table is 27 while t value is more than 1.703 at significance level of 0.05. So the t value of 2.473 at significance level of 0.01 is greater.

Therefore, the validity of the null hypothesis must be abandoned. That is, there is a significant difference in students' acquisition if environmental action programs are implemented for language creativity

## CONCLUSION

1. Implementation of an action program in accordance with the environment for linguistic creativity is more effective.
2. Students will be prepared to take on future global challenges and protect the environment.

## SUMMARY

Sustainable development of students is more effective if planning and implementation of environmental action program as per curriculum components. The thinking process of the students is enhanced. Students are motivated. They express their feelings through universal language writing. By realizing the responsibility of their duty towards the environment, the students are able to sow the future global challenges.

## REFERENCES

1. Kundale, M. Ba. 1991 Sarjanshilta Pune : Nutan Prakashan Patankar Jayashri. 2010 Sanshodhanache Prakashan and Padhati – Shrirampur : Shabdalay Prakashan
2. Mali, V. Za. 2016 Balakancha Vikas v Swa chi Janiv – Kolhapur : Fadake Prakashan.
3. Mule, Ra.Sh. Ani Umathe, V.Tu 1998 – Shaikshanik Sanshodhanache Multatve – Aurangabad Maharashtra Vidyapeeth Granth Nirmiti Mandal.
4. Sawant, Suresh 2022 Balsahityani Balshikshanacha Anubandh – Nanded : Sangat Prakashan Kshirsagar, Shakuntala. 2012 Prabandh Lekhanachi Padhati Pune : Universal Prakashan.
5. Bes. J. W. & Khan J.V. 2007, Research In Education, New Delhi. Prentice Hall of Indian Pvt. Ltd.
6. Kothari, C.R. 2011, Research Methodology, Methods, and techniques, New Delhi : New Age International Publication

### Web References

7. <https://shodhganga.inflibnet.ac.in/>
8. <https://en.wikipedia.org/>
9. <https://www.oxfordlearnersdictionaries.com/>



# Beyond Profit : The Well-being Agenda of the 5IR

**Mamata Mukund Ghotal**

Department of Education  
Shivaji University  
Kolhapur, Maharashtra  
✉ [mamataghotal00@gmail.com](mailto:mamataghotal00@gmail.com)

**Sarjerao P. Chavan**

Guide  
Shri. Maharani Tarabai Govt. College Education  
Kolhapur, Maharashtra  
✉ [chavansp2017@gmail.com](mailto:chavansp2017@gmail.com)

## ABSTRACT

The concept of a "welfare agenda" in the context of the Fifth Industrial Revolution (5IR) goes beyond traditional economic measures such as profit and GDP. Built on the foundations of the Fourth Industrial Revolution (4 IR), the 5IR is characterized by the convergence of digital, biological and physical technologies. In this era there is a growing recognition that technological advancement should not only focus on financial gain but also on the overall well-being of individuals and society. The Fifth Industrial Revolution (5IR) represents the transformation of our society through emerging technologies such as artificial intelligence, blockchain, Internet of Things (ICT) and other advanced technologies. 5 The welfare agenda in IR often includes considerations beyond economic growth and profit, focusing on the broader impact of technological progress on individuals, communities, and the environment.

The agenda of the Fifth Industrial Revolution (5IR) seeks to have a transformative impact on social well-being. Shifts focus from traditional profit oriented models to a more holistic and inclusive approach. It explores the multifaceted aspects of 5IR. and individuals to address global challenges and emphasizes the potential to improve the quality of life for communities. It examines how emerging technologies such as artificial intelligence, biotechnology and renewable energy can be used to create sustainable and just solutions. In addition, they prioritize not only economic prosperity, but also social and environmental well-being.

**KEYWORDS** : *Fifth Industrial Revolution (5IR), Well-being, Beyond Profit.*

## INTRODUCTION

The term "beyond profit" suggests an approach. One that goes beyond traditional profit-oriented goals in businesses or organizations. Instead, it means a broader and more holistic approach that considers factors beyond economic benefits, such as social and environmental impacts.

The 5IR's welfare agenda often focuses on welfare in the context of the 5IRs of the Fifth Industrial Revolution. The concept of the Fourth Industrial Revolution (4 IR) emerged to describe the ongoing transformation of traditional industries. These factors include digitization, automation and technological advancement.

The fifth industrial revolution may expand this paradigm

by incorporating emerging technologies such as artificial intelligence, biotechnology and more. Integrating the well-being agenda within the framework of the 5IRs is economic development along with human well-being, social equity and environmental sustainability.

This may indicate a shift in preference. This may include considering the effects of technological progress on individuals, communities and the planet.

In practice, organizations that adopt a "beyond profit" approach to the 5IRs can engage in activities that promote social responsibility, ethical practices, and sustainable development. Activities may include employee welfare. It will be important to reduce the environmental footprint and make a positive contribution to society.

**Theories of the Fifth Industrial Revolution**

The Fifth Industrial Revolution (5IR) can be said to have started from 2020, almost European in its concept. It aims to promote harmonious and synergistic cooperation between humans and machines (human-machine interaction). Collaborative robots known as robots serve as an example of this collaboration. 5IR Can engage in giving activities. Activities may include employee welfare. It will be important to reduce the environmental footprint and make a positive contribution to society.

Can engage in giving activities. Activities may include employee welfare. It will be important to reduce the environmental footprint and make a positive contribution to society.

**Theories of the Fifth Industrial Revolution**

The Fifth Industrial Revolution (5IR) can be said to have started from 2020, almost European in its concept. It aims to promote harmonious and synergistic cooperation between humans and machines (human-machine interaction). Collaborative robots known as robots serve as an example of this collaboration. 5IR also emphasizes the well-being of multiple stakeholders, including customers, employees, shareholders, the planet, and humanity as a whole. It emphasizes the humane and ethical use of technology and seeks to impose carefully designed restrictions to minimize its destructive effects on humans.

It calls for adoption of sustainable and renewable energy resources. The focus is not only on profit but also on profit with purpose. This new era seeks to address environmental and social challenges and work for the betterment of mankind. 5IR also prioritizes introducing significant advances in biotechnology, such as smart-cells, bio-fuels, gene therapy and the integration of technology into the human body through "bionic augmentation" and the "Internet of Bodies". The core objective of this fusion is to ensure that technology works for the good of humans and society while prioritizing environmental sustainability.

- 1st : 18th to 19th century urbanization
- 2nd : 1870 to 1914 Major changes in transport, seed socio-economic environment
- 3rd : 1980s Digital Revolution
- 4th : 21st century intelligent technologies, advent of blockchain, IOT robotics
- 5th : Responsive 21st century innovation, human and machine together

**HISTORY OF INDUSTRIAL REVOLUTION**



**Some key aspects of the 5IR welfare agenda**

**Human Centric Technology**

Emphasis is on human-centered technology design and deployment. Known as technology that prioritizes human needs and experiences. These include technologies that improve health, education and overall quality of life.

**Inclusive Growth**

The 5IR welfare agenda is inclusive and promotes more systems that benefit the wider population. Its aim is to

ensure that the benefits of technological progress are reaped by reducing social inequality.

It ensures that the benefits of inequality and technological progress are distributed more equitably.

### **Environmental Sustainability**

The 5IR welfare agenda recognizes the importance of environmental sustainability. Technologies are developed with a focus on reducing environmental impact, promoting clean energy and addressing climate change. Examining the environmental impact of technological advancements and promoting sustainable practices to reduce the negative impact on the planet.

### **Health and wellness**

Innovations in healthcare technology, preventive medicine, and personalized healthcare contribute to improved health outcomes and overall well-being. Telemedicine, devices and advanced diagnostics which can promote health and wellness.

### **Education for the Future**

The Health Agenda acknowledges the transformative role of technology in education. It seeks to provide accessible and effective education for all, prepare individuals for the evolving job market and promote lifelong learning.

### **Ethical and Governance**

The development of artificial intelligence (AI) and other advanced technologies has increasingly focused on ethical considerations. Strong governance is essential to ensure responsible and transparent use of technology.

### **Community and social connection**

5IR's well-being agenda recognizes the importance of social connection and community well-being. Technology is being used to enhance collaboration, communication and social cohesion.

### **Cultural Preservation**

Efforts are made to use technology to preserve and promote cultural diversity. Digital tools and platforms are being used to preserve cultural heritage and promote cultural exchange.

### **Work-life Balance**

The welfare agenda acknowledges the potential impact of technological progress on the nature of work. It seeks to create a balance between work and personal life, exploring options such as flexible work arrangements and remote work.

### **Data Privacy and Security**

As technology becomes more pervasive, protecting individuals' privacy and securing data are critical components of a wellness program. Strong cyber security measures and clear data protection policies are essential.

The 5IR's welfare agenda aims to focus on holistic development, inclusiveness, sustainability and ethical considerations, using technological advancements for the betterment of humanity. Economic prosperity must be matched by improvements in the overall well-being of individuals, communities, and the planet.

## **SUMMARY**

The transformative potential of the Fifth Industrial Revolution is not only in economic terms but also in promoting social welfare. As we navigate this era of rapid technological advancement, it becomes imperative to prioritize a holistic approach that goes beyond traditional profit-driven motives. The emphasis on welfare suggests a paradigm shift towards a more inclusive sustainable and ethically grounded framework. Integrating technological innovation with a focus on human flourishing, the welfare agenda of the 5IR encourages a more balanced and just future. 5IR changes the way humans and technology interact. Human-centeredness, sustainability and With a focus on resilience, the 5IR aims to create a future where

technology serves humanity in a responsible and ethical manner, paving the way for a better world. 5IR is not limited to industry but its scope is society wide.

## REFERENCE

1. Ball, Catherine (24 ct. 2022), "How the Fifth Industrial Revolution Will Affect the Future of Work," CEO Magazine <https://www.theceomagazine.com/business/innovation-technology/fifth-industrial>.
2. European Commission (2021), "Industry 5.0 towards a sustainable, human-centred and resilient European industry".  
<https://msu.euramet.org/current-calls/documents/EC-Industry-5.0.pdf>.
3. Schwab, Klaus (2016), "The Fourth Industrial Revolution," world Economic Forum.
4. The-Fourth Industrial-Kfd-Revolution <https://www.sciencedirect.com> <https://www.fingent.com>  
[www.world-economy.com](http://www.world-economy.com)

# The Role of Challenges in the Study of Upper Primary Level Students

**Sarjerao Krishnat Sutar**

Researcher Student  
Shivaji University  
Kolhapur, Maharashtra  
✉ sarjeraosutar0@gmail.com

**R. V. Vanbatte**

Guide with Department of Education  
Associate Professor  
Sadguru Gadge Maharaj College  
Karad, Maharashtra  
✉ rbvazad@gmail.com

## ABSTRACT

Studying is a continuous process. The student is the central element in the learning process. It is necessary to change the education process according to the times. Today's children are the creators of tomorrow and the informed citizens of the future. For this, it is necessary to provide quality education to all. According to the National Education Policy 2020, the students of today should develop 21st century skills to be recognized globally. Citizens who have the ability to lead the world through school education. Students should face global challenges from now on. For this, to develop the 6C's - Critical thinking, Creative thinking, Collaboration, Communication, Confidence, Compassion, it will not be advisable to teach in the traditional way at the school level. Inquisitiveness will develop in them, students will be able to meet and accept challenges, they will be motivated to learn on their own. In this regard, their study process must be done. At present, in primary schools, after class teaching from class 1 to 7, students are asked to solve the homework. They do not work with enthusiasm and self-motivation. Often, students are not interested in studying as they have to copy the given work. That homework remains incomplete. Their thinking process is not stimulated. As a result, they do not enjoy studying.

Even the teachers do not get the output of their teaching work. Therefore, when students are given homework in a challenging form that stimulates their thinking process, which stimulates their intellect, the students themselves prepare such challenging questions by thinking and thinking. Therefore, the speed of study increases three times than before. Also, the teaching of teachers Work comes halfway through. A series of challenging activities grade wise at class level instills a love of learning in students. Helps to make learning easy and fun. The challenge creates a positive atmosphere in the classroom and gives every student an opportunity to work according to their ability and full potential. In this research, a series of challenges were made for the class of elementary level class VII according to the subjects Marathi and Mathematics. As a result, positive effects are seen on the students' studies. By creating the motivation and ability to self-study in the students, their learning speed increases.

## INTRODUCTION

Challenging children to learn is one of the first six of the seventeen items that provide the most immediate results and motivates teachers according to the visionary education approach. Children love challenges because they respond very well to challenges

compared to homework. For which the English word Home work is used. Home work literally translates to ghar kam or homework in Marathi and it is correct too. Homework given to children should feel like homework. He should be able to do what he likes easily. He should be willing to do this work. But how much of the study



given in our school falls into this category? This is the question. Meaning, they get bored because they don't feel challenged in this type of study. Disgruntled, unhappily doing the work as told by the class teacher. They do not participate in it wholeheartedly. As a result of this, things like not studying, not doing what is done effectively or not getting results are seen. Children enjoy learning

Challenges work to create a vision to see challenges in life as challenges rather than problems.

The act of challenging has a definite connection to the psychological relationship of awakening consciousness. Challenging students to learn, then, is an incredibly effective process. What is a challenge and how to overcome it? Various challenges are given at school level or class level. Various subject or extra subject challenges can also be given. A challenge does not have a task limit, if any, a time limit is imposed. The challenge is to do the most work on a given subject in a given time. Children use their maximum potential. There is competition to make your work more and better. Its effect is visible in the children's performance. What would challenge children? So the limits we have set for ourselves. The ability of many students to be contaminated by the limitations of class, grade, prejudices regarding the students, most of the time the teacher, school, family, society etc. It is not known to many. All this applies to us. The limitations of our grade, curriculum and preconceived notions about students keep us trapped.

The theory of breaking limits basically requires a calm mind. Only then 'children can be read'. Reading it will break the limits of challenges. The present system paints a picture of children being subjugated and disenfranchised, the rural classes that today are attracted to English medium schools. Their education is currently being done in the form of 'spoon feeding'. In excess of this, the ability of the students to face the challenges is taken away. This is a fact. Due to the importance of the English language, there has been a great commitment to their education. The fashion of keeping the child trapped in different classes outside the school hours has resulted in the loss of spontaneity in the child and seems to impair decision making. This is like taking away leadership from children in education. Now, if we

look into our government schools, we will see that even in government schools, the teacher has trapped himself within the limits. Sometimes within the limits of the teaching technique, sometimes within the limits of the textbook and still others. The picture is that students are unable to meet the challenges in our established system. A question is always raised on our education system that one hundred and forty crores

Will countries provide only servants to each country? Google's CEO will be Indian then why not the founder of Google? So why did this happen? One reason is that our education system has removed the challenge of learning and banished student leadership from education. The only thing that can reverse this is a challenging approach to education. Education is a key tool for personal development by adapting to modern changes with time. The new education policy- 2020 will equip students with a sense of responsibility, skills and knowledge to enhance human rights, sustainable development and livelihoods for global well-being in 2020. The goal of education is to create global citizens who develop values. The root of the progress of Western countries is found in their education system. Therefore, for a self-reliant India, there is a need to make a change in our education system. Similar changes in the classroom change in the study process, including challenges in Swadhyaya has become the need of the hour.

### Concept

Upper Primary School –

Higher Primary School is a system that provides education from class VI to class VIII.

[RTE 2009]

### Students

A learner is a person who acquires new knowledge.

[Wikipedia]

### Study

Learning is the permanent change in human behavior due to effort or experience.

### Challenges

Challenges are something new and difficult that the clinician must think about.

## OBJECTIVES

- 1] To find out the study level of students in upper primary school.
- 2] The Role of Challenging Subjects in the Learning of Upper Primary School Students to know.
- 3] Linking the learning challenges of upper primary school students.
- 4] To motivate students to explore global challenges.
- 5] Developing study speed using challenges.

## RESEARCH METHODOLOGY

Secondary material has been used for the present study and in this a detailed study has been done by studying the reference books research paper magazines and internet.

### Subject Description

When facing challenges in the 21st century, challenges should be in the 21st century. Challenges are very effective in speeding up learning. The World Health Organization has defined the challenges of the twenty-first century.

The World Health Organization listed ten life skills as essential for every human being for positive growth and good quality of life:

- (1) Communication Skills
- (2) Creative Thinking
- (3) Critical Thinking
- (4) Decision Making
- (5) Empathy
- (6) Interpersonal Relationships
- (7) Managing Emotions
- (8) Management of Stress
- (9) Problem Solving
- (10) Self-awareness

### A] Four levels of difficulty should be considered while giving challenges in the classroom

- (1) Can be given to students of all levels in the class
- (2) Challenges that can be given to students at ASER level.

- (3) Challenges to be given to NAS level students.
- (4) Challenges that can be given to students at the PISA level.

### B] Depending on the number of children, three aspects of the challenges should be noted

- (1) The challenge of compassion at the individual level
- (2) The challenge of giving among peers
- (3) Dayavaya's challenge in the group. A closer look at the challenge as above The response from the students is good.

### C] Study Speed Level

While giving challenges, it is noticed that not all the challenges given are getting 100% response from the students. In case of some challenges, some students in the class do not respond as expected. Apart from the exceptional reasons, one important reason is that the difficulty level of the challenges given to them was more. According to the level of study there are three levels of students. If there is a challenge at PISA level, that challenge will be difficult for students of ASER and NAS level. So it is necessary to consider study pace while giving challenges.

#### 1] ASER Level

Children whose learning speed is slow. Those who do not have basic abilities. Students of such study level come in ASER study level.

#### 2] NAS Level

Children learning at a moderate pace who have acquired basic competencies and are achieving academic results at grade levels. Students of such study level fall into NAS study level.

#### 3] PISA Levels

Children who learn at a faster pace. Children who have completed academic achievement. And need more intellectual nourishment. Students at such study levels fall into PISA study levels.

### D] Nature of Challenges

Acceptability Student ability More work in less time  
Nature of Peer Learning Challenges Time Management

Motivation Study Results Interest Student Study Process:

Action Program to challenge students' learning:

### The nature of subject challenging learning

#### Marathi

- 1] Creating challenging questions based on the text
- 2] Finding answers to questions through internet, YouTube.
- 3] Poetry, Essay writing according to text.
- 4] Collection of folk songs.
- 5] Collecting information of dignitaries.
- 6] Creating challenging questions based on word wealth.
- 7] Challenging questions based on advertisements 8] Challenging questions based on grammar.
- 9] Challenging questions based on word puzzles.
- 10] Challenging questions based on the passage.
- 11] Email information.
- 12] Use of QR code.
- 13] Compilation of information on Marathi literature.

#### Maths

- 1] Challenging examples on numbers.
- 2] To solve more and more examples of addition, subtraction, multiplication, division operations on numbers in minimum time.
- 3] Questions on Geometric Figures. 4] Graph Based Questions.
- 5] Challenging Questions on Bank Transactions. Getting real information. 6] Creating challenging examples of statistics.
- 7] Creating challenging examples based on chronology.
- 8] Creating challenging examples based on measurement. 9] Creating challenging examples based on fractions to do.
- 10] Creating challenging examples based on

information management.

- 11] Creating challenging examples based on area.
- 12] Creating challenging examples based on circles.
- 13] Creating challenging examples based on percentages.
- 14] To express one's opinion on the practice done.
- 15] Finding open-ended questions and their answers.

### CONCLUSION

- 1] Study level of students in upper primary school was explored in this ASER,NAS,PISA level students appeared.
- 2] Students are more motivated by relating their learning to daily challenges Challenges started to be resolved.
- 3] Connecting students to study challenges makes the learning process enjoyable. 4] Stimulated the student's curiosity and the clinician's thought process.
- 5] The habit and attitude of accepting challenges increased in the students. Student They accept challenges according to their abilities and complete them with self-effort.
- 6] While completing the student challenges their physician attitudes were boosted. Therefore The speed of his studies increased and the study process became fruitful.
- 7] The student begins to explore global challenges as well as their solutions Started trying. 8] Using challenges increased study speed.

### REFERENCES

1. Deepika [2014] Effect of individualized educational program on learning of functional skills among mentally challenged children in inclusive setting.
2. Kumari Usha, [2019] The Challenges Faced By The Stakeholders In Implementing Inclusion In Teacher Education.
3. Jinto M [2020] Effect of Problem Based Learning with Metacognitive Scaffolding on Achievement in Sociology Problem Solving Ability and Social Skills among Higher Secondary Students.

4. Rashmi Pokharna [2021] A Study of Relationship between Motivation and Self Regulated Learning Processes in English Language Learning
5. Paray, Arsheed Ahmad, [2021] A Case Study of Access Enrollment and Quality Education of Physically Challenged Students of Jammu and Kashmir
6. Jagjit Kaur [2021] Impact of problem based learning and concept mapping strategies in science on achievement problem solving ability and self regulated learning skills among ninth class students
7. Rahela Khatoon, [2022] Professional Development for Teacher Educators Status and Challenges A Study.
8. Anil Prasad Kushwaha, [2022] Primary education in Bihar progress and challenge.
9. Meseret Getachew Tessema [2022] The relationship of university students engagement with teaching style learning style and academic achievement in Ethiopia.
10. Chopra, Lakshmi [2023] Effect of experiential learning strategies on learning outcomes and interpersonal skills of senior secondary students in relation to learning approaches.
11. Singh, Rupamala [2023] Impact on active and outdoor learning environment on students engagement attitude and learning outcome A Study Conducted in Kotdwara Uttarakhand.
12. Gupta, Shweta [2023] Impact of Elearning and Online Information Resources on Students Learning Outcome Academic Performance and Creativity A Study.
13. KumarJ [2023] Effect of brain based learning on self regulation skill and learning achievement in science among secondary school students.

# Enhancing Education Quality through Automated Assessment and Personalized Learning : Tool for Attainment of Sustainable Development Goal No. 4

Ganesh Rathod

✉ ganeshrthd883@gmail.com

Suresh Mane

✉ mane.suresh.dypcoesn@gmail.com

Shivaleela Arlimatti

✉ sarlimatti@gmail.com

Dr. D.Y. Patil Pratisthan's College of Engineering  
Salokhenagar, Kolhapur  
Affiliated to Shivaji University  
Kolhapur, Maharashtra

## ABSTRACT

*The quest for enhanced education quality aligns with the global pursuit of Sustainable Development Goal 4: Quality Education. The educational landscape has witnessed a surge in Outcome-Based Education (OBE) methodology implementation worldwide. Course Outcomes (COs) stand as pivotal elements shaping student learning, meticulously crafted by educators drawing from curriculum guidelines and the Revised Bloom Taxonomy (RBT) levels. Amidst this educational evolution, a pressing challenge persists: the laborious manual creation of assessments, crucial for internal and external evaluations. These assessments, meticulously aligned with RBT levels, play a fundamental role in academic advancement. Acknowledging their significance, this paper introduces an innovative concept. It proposes educators collaboratively curate an extensive repository of questions categorized by difficulty levels, following the RBT framework. A collective effort fosters a comprehensive question bank, leveraging the collective expertise of subject-matter peers. This approach excels traditional boundaries, encompassing diverse assessment formats—from unit test papers to project evaluations and internships. Embracing technology, the paper advocates for a solution where educators, empowered by our technological tool, swiftly generate tests and question papers, integrating cutting-edge randomization and shuffling methods. Moreover, the system extends beyond assessments, offering tailored activities catering to students across different learning paces—slow, average, and fast learners—as per educators' preferences. In essence, this paper advocates a holistic paradigm shift in education enhancement. By combining assessment automation with personalized learning strategies, it strives to elevate the quality of education and foster inclusive learning environments for diverse student needs.*

## INTRODUCTION

Sustainable Development Goal 4 (SDG 4) advocates for universal access to quality education, a cornerstone for societal development and progress. Despite India's significant strides since gaining independence 76 years ago, the nation remains in a transitional phase, characterized by a reliance on factors like unskilled labor and natural resources. However, to propel India toward the status of a developed nation, a target set for the centennial anniversary in 2047, a shift toward innovation-driven economies becomes imperative. Central to this transformative journey is harnessing the technical acumen and innovative

potential of its populace, highlighting the critical role of technical education in shaping the nation's future. Within the Indian educational landscape, accreditation bodies such as the National Assessment and Accreditation Council (NAAC) and the National Board of Accreditation (NBA) [1], [2] have laid significant emphasis on Outcome-Based Education (OBE) in evaluating educational institutions. OBE, a globally recognized educational paradigm, pivots on the principle of prioritizing student learning outcomes over the conventional teacher-centric educational approach. This study's focus revolves specifically around the assessment facet of OBE, seeking to ensure impartial



and high-quality evaluations that guide students toward robust learning outcomes.

India proudly hosts a network of over 10,000 institutions offering technical programs, ranging from diploma courses to advanced postgraduate studies. With accreditation becoming a mandatory requirement, there is an amplified impetus for educational institutions to deliver a standard of education that aligns with quality benchmarks [3]. This pursuit of educational excellence resonates with the guiding principles outlined in the National Education Policy 2020 (NEP 2020), which underscores holistic learning, critical thinking, and skill development alongside academic excellence. Amidst the evolution of curricula and the competitive scenario where the demand for technical programs surpasses available seats, educators shoulder a plethora of responsibilities. Balancing the academic rigor with co-curricular and extracurricular activities places considerable strain on teachers, impacting their capacity to diversify question sets and ensure varied question quality across different cognitive levels.

This study identifies two primary challenges that significantly impact the assessment landscape within technical education in India. Firstly, there is a notable difficulty in crafting consistent, high-quality question papers aligned with the Revised Bloom Taxonomy (RBT) levels, which necessitates not only effective teaching methods but also the creation of sophisticated assessment tools. Secondly, teachers in autonomous institutions face an overwhelming burden in managing diverse examination types within stringent timelines. Escalating question complexity in accordance with RBT levels requires meticulous planning and resource allocation. This paper endeavors to address these pressing challenges by presenting model solutions tailored to accommodate the constraints faced by teachers. The primary objectives encompass optimizing question paper formatting, streamlining preparation efforts, facilitating seamless test administration across varied student abilities, and accommodating diverse test formats. By presenting a technologically enhanced framework, this study aims to empower educators, ensuring transparent and equitable evaluations while enriching the academic experience for students.

In summary, this paper seeks to delve into the details

of the assessment landscape within technical education in India, offering pragmatic solutions to enhance the quality of assessments. By bridging the gap between pedagogical practices and assessment methodologies, it aspires to empower educators in their quest to provide a holistic and enriching learning experience, ultimately contributing to the fulfillment of SDG 4: Quality Education.

## LITERATURE REVIEW

Assessment in education has been a focal point for enhancing learning outcomes and ensuring a comprehensive evaluation of students' understanding. Traditional assessment methods often involved manual creation processes, which, despite their importance, have limitations in terms of diversity, efficiency, and alignment with learning outcomes [4]. To address these challenges, recent advancements in technology have spurred the development of automated assessment systems aimed at revolutionizing the creation and administration of tests [5]. The advent of technology-driven assessment solutions has significantly transformed the educational landscape, offering promising prospects for streamlining assessment processes and improving their quality [6]. These solutions, often leveraging machine learning algorithms and sophisticated data management systems, have emerged as powerful tools for educators in crafting assessments that align with learning objectives and cognitive levels [7].

One of the fundamental advantages of technological solutions in assessment automation lies in their ability to reduce human effort and biases associated with manual test creation [8]. Systems equipped with predefined parameters and algorithms ensure the generation of varied and balanced question sets, eliminating predictability and enhancing the diversity of assessment items [9]. Moreover, these solutions enable educators to align assessments with Revised Bloom's Taxonomy (RBT) levels, ensuring that questions cater to diverse cognitive skills [10]. Confidentiality and integrity in the assessment creation process have been critical concerns in education. Technology-driven solutions have addressed these concerns by ensuring secure and confidential test generation, safeguarding against information leaks and maintaining the credibility of assessments [11]. The impact of these technological

advancements extends beyond efficiency and diversity in assessment creation. They play a pivotal role in promoting innovative teaching methodologies and adapting to the evolving needs of learners [12]. By fostering a transparent evaluation system and enhancing the overall quality of education, these automated systems pave the way for individuals to thrive in a competitive professional landscape [13].

However, despite the transformative potential of technology-driven assessment solutions, challenges remain. Some concerns revolve around ensuring the adaptability and scalability of these systems to accommodate diverse educational settings and subjects [14]. Additionally, there is a need for continuous refinement and validation of these systems to ensure their effectiveness and alignment with educational objectives. The literature surrounding assessment automation through technological solutions underscores their potential to revolutionize educational assessment processes. These systems offer promising avenues for enhancing the quality, diversity, and alignment of assessments with learning objectives. While challenges persist, the advancements in assessment automation stand as a cornerstone in advancing the pursuit of quality education and aligning with the aspirations outlined in SDG 4.

## METHODOLOGY

The methodology revolves around three distinct modules, each catering to specific user roles and functionalities. Module 1 focuses on authentication, distinguishing between two key user types: admin users and expert users. Expert users, who serve as subject heads possessing expertise in their respective fields, are responsible for populating Module 2—a database of questions and assignments. Conversely, admin users, encompassing roles such as H.O.Ds, Academic Deans, Examination Deans, or Principals, wield administrative privileges to access Module 3. Within this module, these admin users are empowered to autonomously generate question papers and assignments seamlessly. This methodology advocates a collaborative approach among educators to curate a diverse repository of assessment items. The collaborative model encourages pooling expertise, aligning assessments with Course Outcomes (COs), Performance Indicators (PI), and

Revised Bloom Taxonomy (RBT). The primary objective is to craft a comprehensive question bank that mirrors various cognitive levels, ensuring a well-balanced representation of cognitive skills across assessments.

Technical institutions typically have a Department Advisory Board (DAB) and a Program Assessment and Quality Improvement Cell (PAQIC) overseeing the refinement and enhancement of academic programs. The DAB convenes to tailor the question bank specifically to the academic department's needs. Comprising external experts and industry professionals, the DAB offers valuable insights, guiding curriculum development and ensuring quality assurance mechanisms. The internal committee, known as the Program Assessment and Quality Improvement Cell (PAQIC), directs its efforts toward evaluating and enhancing the department's academic programs. Their involvement in question bank creation aligns with their mission to ensure program excellence and effective assessment. Participants in these meetings encompass senior teachers, academicians, and industry experts, each contributing their specialized expertise to shape the question bank's content. Senior Teachers, drawing from their extensive knowledge of the curriculum, teaching methodologies, and students' learning patterns, contribute to the alignment of questions with program objectives and learning outcomes. Academicians, recognized scholars and theorists, offer questions that challenge higher-order thinking skills, encouraging critical analysis and theoretical comprehension. Meanwhile, Industry Experts infuse practical relevance into the questions, reflecting real-world applications, current industry trends, and emerging skills.

Collaboration among these diverse groups results in a multitude of benefits. Firstly, it leads to a comprehensive question bank encompassing a wide spectrum of knowledge levels, difficulty ranges, and subject areas. Secondly, this collaborative effort ensures the questions are meticulously crafted, accurate, and pertinent to both theoretical concepts and practical applicability. Additionally, the standardized question bank facilitates fair and reliable evaluations of student performance across different cohorts. Moreover, the incorporation of real-world scenarios and skill-based questions equips

students with industry-ready knowledge, preparing them for future careers and professional challenges. Meetings involving these committees often revolve around essential discussion points. These include aligning questions with the curriculum to directly address learning objectives, balancing question types and difficulty levels to cater to diverse student needs, integrating industry relevance through real-world scenarios, case studies, and practical applications, and ensuring fairness and accuracy in assessment through comprehensive scoring rubrics and unbiased question construction.

The methodology integrates student-centric methods and co-curricular activities into the assessment framework. This inclusivity tailor’s assessments to accommodate diverse learning paces—catering to students identified as slow, average, or fast learners. It goes beyond traditional unit tests, encompassing a spectrum of assessment types like project evaluations, internships, and qualitative assessments using rubrics for nuanced evaluation beyond multiple-choice assessments.

The project's architecture employs HTML for front-end development, Node.js for its efficiency in handling I/O operations, and MySQL for secure data storage, particularly pertinent to assessment-related information. Figure 1 illustrates the project's operational modules, where course instructors using a user-friendly HTML interface inputs diverse question details into a comprehensive question bank stored in a MySQL database via the Node.js-powered back end. Administrators leverage a separate HTML-based interface to create question papers for various assessments. They input specifics such as Subject Name, Total Marks, and Difficulty Levels. The system then utilizes Machine Learning (ML) algorithms and randomization techniques in the back end to automatically generate question papers. Notably, this system grants instructors the flexibility to specify question distribution based on learning paces, incorporate various Performance Indicators (PI), and integrate student-centric methods, ensuring an adaptable and comprehensive assessment framework.

**RESULT AND DISCUSSION**

The project's outcomes prominently showcase the utilization of HTML for the user interface, Node.js for backend operations, and MySQL for data storage. Illustrated in Figure 2, the project's interface displays four primary modules presented as accessible buttons: 'Add Questions,' 'Add Student-Centric Methods,' 'Generate Question Paper,' and 'Generate Assignment Using Student-Centric Methods.' This system ensures role-based access, granting exclusive rights to subject in-charges and experts for 'Add Questions' and 'Add Student-Centric Methods,' while administrative personnel—such as HODs, Academic and Examination Deans, and the Principal—possess privileges for 'Generate Question Paper' and 'Generate Assignment Using Student-Centric Methods.'

The administrative function possesses the capability to create question papers at will and set the level of difficulty. Within the admin interface, input fields are available to define parameters like Branch, Semester, Class, Total Marks, Subject Name, and Difficulty Level (Easy and Tough). As an illustration, consider a scenario where a 10-mark question in the Machine Learning

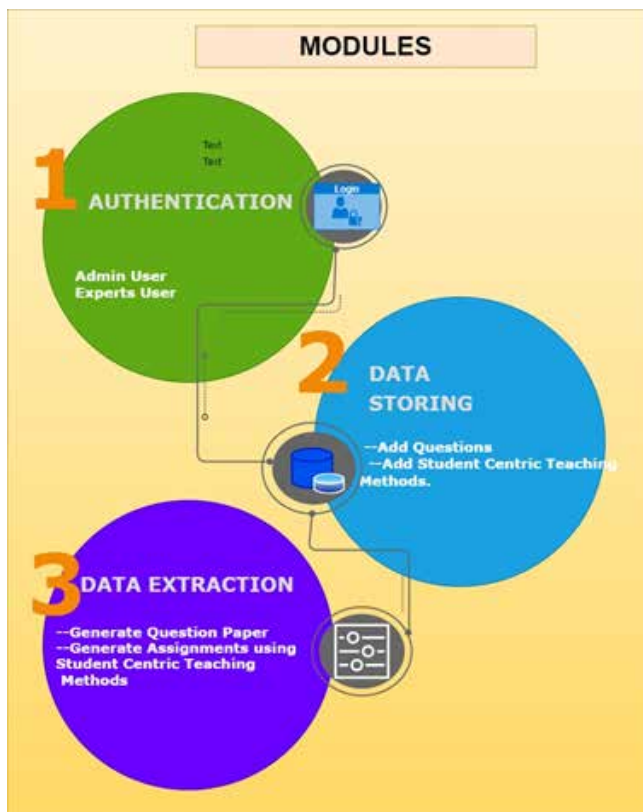

Figure 1. Modules

subject is configured with a difficulty level split of 20% easy and 80% tough.

Dr. D. Y. Patil Pratisthan's College of Engineering, Salokhenagar,  
Kolhapur, India

Welcome

Assessment Automation

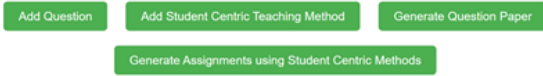

Figure 2. Homepage



Figure 3. Output of Generated Question Paper

Figure 3 showcases the automated creation of a question paper based on specified parameters, displaying Question Number, Question, RBT Level, Performance Indicator, and Marks. For example, in generating a 10-marks question with a distribution of 20% easy and 80% tough, the system autonomously generates two questions: one with 2 marks at RBT Level 1 (considered easy) and another with 8 marks at RBT Level 4 (classified as tough). RBT levels 1 to 2 denote the 'easy' category, while levels 3, 4, 5, and 6 represent 'hard/tough.' Performance Indicators serve as measurable metrics for progress tracking towards defined objectives.

Table 1 offers an extensive comparison between traditional manual methods of question paper creation and the transformative impact of cutting-edge technology on assessment design and development. This analysis delineates the vast contrasts and illuminates the significant transformations observed across critical dimensions of assessment methodologies. Traditional manual approaches often limit the diversity of question types due to human constraints, fostering patterns susceptible to predictability and repetition. In contrast, technological advancements enable educators to create a wide array of diverse question types using algorithms

and computational mechanisms. This innovation breaks the boundaries of predictability, facilitating a more comprehensive evaluation of students' understanding and cognitive abilities.

Table 1. Comparison between Manually generated and Technology-Driven Question papers

Aspect	Manually Generated	Technology-Driven
Process Efficiency	Time-consuming creation process involving meticulous manual efforts	Rapid and automated generation, saving substantial time and effort
Question Diversity	Limited diversity due to repetitive patterns or subjective choices	Diverse question options without repetition, based on predefined parameters
Question Quality	Inconsistencies or bias possible; manual limitations in aligning with RBT levels or learning outcomes	Aligned with RBT levels, COs, and performance indicators, ensuring high-quality questions
Distribution of Difficulty Levels	Manual estimation prone to bias or inconsistencies	Accurate distribution based on predefined difficulty parameters, avoiding bias
Adaptability & Scalability	Limited adaptability or scalability for modifications or adjustments	Highly adaptable, allowing swift adjustments or modifications based on changing needs
Human Errors	Potential for human errors in question structuring or alignment with learning objectives	Reduced human error through automation, maintaining consistency and accuracy
Secrecy & Transparency	Vulnerable to information leakage or lack of transparency in question setting	Maintains complete secrecy, unknown to students or even subject instructors, ensuring transparency in the question-setting process
Student-Centric Approaches	Challenging to cater to diverse learning paces or varied assessment types	Facilitates inclusion of student-centric methods, accommodating diverse learning paces and preferences



This comparison table illustrates how technology-driven approaches in generating question papers align with SDG 4's focus on Quality Education by addressing various aspects such as efficiency, diversity, quality, adaptability, transparency, and inclusivity in assessment methods.

## CONCLUSION

In our pursuit of SDG 4 - Quality Education, our technological solution for assessment automation stands as a pivotal advancement. By significantly reducing the manual efforts involved in crafting test materials, it initiates a transformative shift towards a more diverse and dynamic assessment landscape. This revolution empowers educators to define question difficulty levels and align them with specific RBT levels, fostering the swift generation of tests devoid of repetitive and predictable questions inherent in manual processes. Furthermore, the system's commitment to maintaining complete confidentiality in question paper creation not only saves time but also minimizes human errors. Its meticulous management of difficulty levels across questions ensures the creation of robust and balanced assessments, a crucial component in advancing the quality of technical education. This innovative solution contributes profoundly to technical education by fostering innovation and adaptability among learners while elevating the overall assessment quality. It not only augments teaching and learning experiences but also cultivates a transparent evaluation system, essential for nurturing individuals for success in a competitive professional landscape.

In essence, our technological solution stands as a beacon of transformation in assessment creation. By streamlining processes and elevating educational standards, it heralds an era characterized by enriched learning experiences and a heightened pursuit of academic excellence, aligned with the aspirations outlined in SDG 4.

## REFERENCES

1. Suresh. D. Mane, "Accreditation of UG Engineering Programmes in India: Enhanced Role of Teaching Fraternity. International Journal of Scientific Engineering and Applied Science (IJSEAS) - Volume-1, Issue-6, September 2015. ISSN: 2395-3470.
2. Suresh. D. Mane, "NBA and NAAC Accreditation of UG Engineering Programmes/Colleges in India: A Review". International Journal of Scientific Engineering and Applied Science (IJSEAS) - Volume-1, Issue-6, September 2015 ISSN: 2395-3470.
3. Naveen, H. M. "AICTE Initiatives for Quality Enhancement in Technical Education." International Journal of Scientific Research in Science and Technology 8, no. 4 (2021): 382-390.
4. Saher, Al-Sabbah, Al Momani Jihad Ali, Darwish Amani, and Fares Najwan. "Traditional versus Authentic Assessments in Higher Education." Pegem Journal of Education and Instruction 12, no. 1 (2022): 283-291.
5. Höffner, Konrad, Sebastian Walter, Edgard Marx, Ricardo Usbeck, Jens Lehmann, and Axel-Cyrille Ngonga Ngomo. "Survey on challenges of question answering in the semantic web." Semantic Web 8, no. 6 (2017): 895-920.
6. Serra, Domenico, Giovanni Grano, Fabio Palomba, Filomena Ferrucci, Harald C. Gall, and Alberto Bacchelli. "On the effectiveness of manual and automatic unit test generation: ten years later." In 2019 IEEE/ACM 16th International Conference on Mining Software Repositories (MSR), pp. 121-125. IEEE, 2019.
7. Ibrahim, Walid, Wissam Ibrahim, Taoufik Zoubeidi, Sayed Marzouk, Amr Sweedan, and Hoda Amer. "An Online Management System for Streamlining and Enhancing the Quality of Learning Outcomes Assessment." Education and Information Technologies 27, no. 8 (2022): 11325-11353.
8. Ferreira, Pedro NP, and José Juan Cañas. "Assessing operational impacts of automation using functional resonance analysis method." Cognition, Technology & Work 21 (2019): 535-552.
9. Boykin, A. Wade. "Human diversity, assessment in education and the achievement of excellence and equity." Journal of Negro Education 83, no. 4 (2014): 499-521.
10. Krathwohl, David R. "A revision of Bloom's taxonomy: An overview." Theory into practice 41, no. 4 (2002): 212-218.



11. Kurdi, Ghader, Jared Leo, Bijan Parsia, Uli Sattler, and Salam Al-Emari. "A systematic review of automatic question generation for educational purposes." *International Journal of Artificial Intelligence in Education* 30 (2020): 121-204.
12. Elhoseny, Mohamed, Noura Metawa, and Aboul Ella Hassanien. "An automated information system to ensure quality in higher education institutions." In *2016 12th International Computer Engineering Conference (ICENCO)*, pp. 196-201. IEEE, 2016.
13. Durgesham, G., Md Naseer, S. Srinivas, Nazneen Fatima, and Shaik Noorshaba Abdul. "A qualitative study on challenges of higher education in India." *Journal homepage: www.ijrpr.com ISSN 2582 (2022): 7421.*
14. Reddy, Leelakrishna, Machaba Leanyatsa Letswalo, Amanda Percy Sefage, Bonginkosi Vincent Kheswa, Avula Balakrishna, Jesman Moreblessing Changundega, Mashinga Johannes Mvelase et al. "Integrity vs. Quality of Assessments: Are They Compromised on the Online Platform?." *Pedagogical Research* 7, no. 2 (2022).

# Enhancing Higher Education: A Comprehensive Review of Outcome-Based Education Methodology and Course Outcomes Attainment in Pursuit of UN SDG No. 4

**Suresh Mane**

✉ mane.suresh.dypcoesn@gmail.com

**Ganesh Rathod**

✉ ganeshrthd883@gmail.com

**Shivaleela Arlimatti**

✉ sarlimatti@gmail.com

Dr. D.Y. Patil Pratisthan's College of Engineering  
Salokhenagar, Kolhapur  
Affiliated to Shivaji University  
Kolhapur, Maharashtra

## ABSTRACT

UN Sustainable Development Goal (SDG) No. 4 highlights the imperative of Quality Education as a catalyst for global progress. Recognizing this, Outcome-Based Education (OBE) has emerged as a pivotal approach endorsed by institutions like the National Board of Accreditation (NBA) and National Assessment and Accreditation Council (NAAC) in India. These bodies, overseeing accreditation for over 50,000 higher education institutions encompassing diverse fields, underscore the significance of OBE methodology for enhancing educational quality across streams such as engineering, law, medicine, and more. This paper serves as a comprehensive guide for educators navigating the OBE framework. It offers insights into crafting course outcomes in line with revised Bloom's taxonomy, outlining the iterative steps involved in the process. Additionally, it explores a spectrum of direct and indirect assessment tools—from surveys to interviews, self-assessment mechanisms, course evaluations, and program-level assessments—evaluating their suitability, reliability, and alignment with course outcomes. Delving further, this paper illuminates strategies for achieving both attained and unattained course outcomes. Through an in-depth case study of a specific institution's course, the methodology of OBE implementation is elucidated, providing practical insights for educators aiming to enhance their course quality and students' learning objectives. This paper acts as an invaluable resource for instructors seeking to augment their teaching practices within the OBE paradigm, emphasizing the pivotal role of outcome-based education in fostering individual empowerment and advancing towards a more robust and equitable society through the transformative power of quality education.

**KEYWORDS** : *Outcome based education, Course outcomes, Revised blooms taxonomy.*

## INTRODUCTION

Education stands as a formidable force, empowering individuals and laying the foundation for societal advancement. It equips people with the knowledge, competencies, and abilities vital for realizing aspirations, contributing to community development, and fostering a brighter future. Central to these aspirations is Sustainable Development Goal 4 (SDG 4), which champions the provision of high-quality education. This goal underscores the belief that education serves as a potent catalyst for sustainable development, aiming to ensure inclusive, equitable access to affordable vocational training, bridging gender and wealth disparities, and

attaining universal access to quality higher education. By 2030, the ambition is to create equal opportunities for all genders to access affordable, quality technical, vocational, and tertiary education, including university-level education. Moreover, the goal seeks to instill in all learners the knowledge and skills crucial for supporting sustainable development. This encompasses education on sustainable practices, human rights, gender equality, cultivating a culture of peace, global citizenship, and embracing cultural diversity's role in advancing sustainability.

Governments worldwide recognize education's paramount significance and have taken strides to

facilitate accessible, quality education for their citizens. An instrumental approach embraced by many higher education institutions toward elevating educational standards is Outcome-Based Education (OBE). This methodology centers on predefined educational outcomes, guiding teaching, learning, and assessment endeavors. Notably, in India, bodies like the National Board of Accreditation (NBA) and National Assessment and Accreditation Council (NAAC) have adopted OBE to evaluate and accredit higher education institutions across the country. This adoption of Outcome-Based Education resonates profoundly with SDG No. 4, aligning with its vision of equitable, inclusive, and quality education for all. By embracing OBE, institutions pave the way for a paradigm shift in education, amplifying the pursuit of sustainable development goals while ensuring that education becomes a transformative force, empowering individuals and nurturing a society geared towards comprehensive growth and equitable opportunities for all. This paper aims to present a comprehensive evaluation of the Outcome-Based Education (OBE) methodology implemented by the NBA and NAAC in India and its profound impact on higher education institutions' educational quality. Additionally, it offers a detailed, step-by-step guide for course instructors, outlining the process of formulating course outcomes. The research explores a spectrum of direct and indirect assessment tools—comprising surveys, interviews, self-assessment instruments, course evaluations, and program-level assessments—scrutinizing their appropriateness, validity, reliability, and alignment with course outcomes. Moreover, it delves into strategies for achieving both attained and unattained course outcomes. The primary objective is to serve as a vital resource for course instructors seeking to enhance course quality and aid students in accomplishing their learning objectives. Emphasizing the pivotal role of OBE, this paper underscores its significance in fostering societal progress through the empowerment derived from quality education.

The paper's structure encompasses key segments: a literature review consolidating existing research on OBE and its efficacy in enhancing education quality; the methodology section detailing the data collection and analysis approaches employed; the results section presenting the study's findings; and the conclusion,

summarizing essential points and proposing avenues for future research. This comprehensive framework endeavors to offer insights that enrich educational practices and contribute to ongoing advancements in educational quality.

## LITERATURE REVIEW

This literature review aims to provide a comprehensive understanding of OBE methodology, focusing on course outcomes attainment and the assessment tools used in higher education institutions. Education is a powerful tool for empowerment, and governments worldwide are striving to provide quality education to their citizens at an affordable cost [1]. Outcome-based education plays a crucial role in achieving this goal by focusing on measurable learning outcomes. Outcome-based education (OBE) methodology has gained significant attention in higher education institutions worldwide due to its potential to enhance student learning outcomes and program quality [2]. OBE focuses on defining clear and measurable course outcomes that align with program objectives [3]. By explicitly stating the expected knowledge, skills, and attitudes that students should acquire, OBE provides a framework for designing effective curriculum and assessment strategies. This approach emphasizes student-centered learning, where learners actively engage in the learning process and take responsibility for their own progress. Through the implementation of OBE, institutions aim to produce graduates who possess the necessary competencies to succeed in their chosen fields [4].

Assessment plays a crucial role in outcome-based education, as it provides evidence of students' attainment of course outcomes and guides instructional decision-making [5]. Various assessment methods and tools are employed to measure student learning outcomes, including traditional exams, projects, portfolios, and performance-based assessments [6]. Traditional exams, such as multiple-choice tests, are commonly used to assess students' knowledge and understanding of course content [7]. However, they may not capture higher-order thinking skills or the ability to apply knowledge in real-world contexts. In contrast, performance-based assessments, such as simulations or case studies, provide opportunities for students to demonstrate their skills and competencies in authentic situations. These assessments

often require students to apply their knowledge, analyses complex problems, and make informed decisions. By using a combination of assessment methods, instructors can obtain a comprehensive understanding of students' learning outcomes and provide targeted feedback for improvement [8]. The implementation of outcome-based education requires a systematic approach to curriculum design and development [9]. Curriculum mapping, a process that involves aligning course outcomes, instructional strategies, and assessment methods, is a valuable tool in ensuring the coherence and alignment of the curriculum. Through curriculum mapping, instructors can identify gaps, redundancies, and areas for improvement in the curriculum, leading to a more integrated and meaningful learning experience for students. Additionally, curriculum mapping facilitates the identification of opportunities for interdisciplinary learning and the integration of real-world applications into the curriculum [10]. By aligning the curriculum with industry needs and societal demands, institutions can better prepare students for the challenges of the workforce and contribute to their overall empowerment. The author in [11], conducted a study in engineering colleges within the Belagavi region of Karnataka, India, involving faculty and final year engineering students. The research identified nine key suggestions to improve the employability of engineering graduates, with a focus on enhancing student engagement through seminars, assignments, and mini projects, as well as promoting proactive learning among teachers through annual training and journal paper publication.

The implementation of outcome-based education requires a supportive institutional environment that fosters collaboration, professional development, and continuous improvement [12]. Institutions need to provide faculty members with the necessary resources, training, and support to effectively design and implement outcome-based curriculum [13]. Professional development programs can help instructors develop a deep understanding of the principles and practices of outcome-based education and equip them with the skills to align course outcomes, instructional strategies, and assessment methods. Furthermore, creating a culture of continuous improvement is essential for the successful implementation of outcome-based education. Institutions should establish mechanisms

for collecting and analyzing data on student learning outcomes, soliciting feedback from stakeholders, and using evidence-based practices to enhance the quality of education [14]. By fostering a supportive and collaborative environment, institutions can empower faculty members to embrace outcome-based education and contribute to the overall success of the educational institution [15]. As the accreditation bodies in India ie NAAC and NBA have adopted the OBE in their revised framework from 2015, it is imperative that the role of teaching faculty has new dimensions added to it [16]. Both the NAAC accreditation (University/ Institute accreditation) and NBA accreditation have various criteria and metrics to objectively assess and accredit the institutes based on benchmark's set by them [17].

## METHODOLOGY

The Program Outcomes (POs) serve as comprehensive objectives outlining the expected achievements of students upon completing their program. Offering a broad framework, POs guide course design and facilitate student learning assessment. Aligned with the Washington Accord, there are typically 12 POs covering diverse aspects of knowledge, skills, and attitudes. Following the understanding of POs, the subsequent step involves framing Program Specific Outcomes (PSOs), tailored to the specific program or discipline, providing a focused perspective that aligns with course goals. It is essential to comprehend the six levels of the Revised Bloom's Taxonomy (RBT) concurrently, categorizing learning outcomes into various cognitive levels.

With a clear understanding of POs, PSOs, and RBT levels, the subsequent step is to formulate Course Outcomes (COs). These specific statements articulate the intended learning outcomes for individual courses, aligned with corresponding PSOs. Mapping COs with POs and PSOs ensures alignment with overall program goals, enabling educators to monitor students' progress and assess the contribution of COs to broader program outcomes. Course Attainment plays a pivotal role in ensuring the efficacy and quality of an educational program.

It encompasses a methodical approach empowering educators to evaluate and quantify the degree to which

students attain specific learning outcomes, as illustrated in Figure 1. The successful execution of Course Attainment requires a grasp of key elements. Effective assessment tools, including exams, assignments, projects, and presentations, tailored to align with COs, are crucial for evaluating student learning reliably. The subsequent steps involve setting the threshold and CO targets, representing the minimum acceptable achievement level and the desired attainment level, respectively. If the CO target is met, the threshold may be raised in subsequent years to maintain a challenging standard. Conversely, if the target is not achieved, continuous improvement plans should be devised to address any course or instructional method gaps. Course Attainment follows a systematic process, involving understanding POs, framing PSOs, grasping RBT levels, developing COs, mapping COs with POs and PSOs, selecting appropriate assessment tools, setting thresholds and CO targets, and planning for continuous improvement. By adhering to this process, educators can ensure their courses align with program goals, assess student learning effectively, and consistently enhance the quality of education provided.

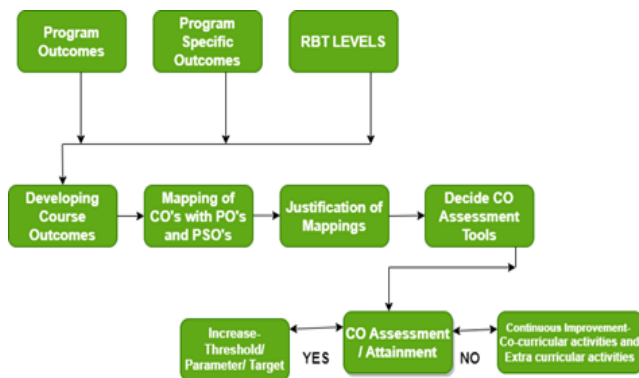

Figure 1. Course Outcome Attainment Process

### CO GENERATION, ATTAINMENT CALCULATION AND DISCUSSION

In OBE based on the POs and PSO defined, various courses are incorporated in the curriculum with fixed number of credits based on the number of teaching hours. Normally one credit equals 12 to 15 teaching hours and for a 4-credit course there should be 4 to 6 CO developed. Engineering programs offered globally have 150 credits, AICTE in recent years has fixed 4-year undergraduate engineering program to 160

credits but some universities have extended it to 180 or even 200 credits. In view of AICTE approving the examination reforms policy, soon we may see its wide spread application and open book examination will be the norm in years to follow.

### Revised Blooms Taxonomy

In 1956, Benjamin Bloom and his team introduced the framework for categorizing educational goals. The Revised Bloom's Taxonomy, an updated version, surpasses the original model, addressing its shortcomings and aligning with contemporary educational practices. Illustrated in Figure 2, this revised taxonomy organizes cognitive skills into six levels, placing a significant emphasis on active learning and higher-order thinking. At the foundational "Remembering" level, learners are tasked with recalling or recognizing facts, information, or concepts, demonstrating the ability to retrieve knowledge and identify key elements. Progressing to the "Understanding" level, learners showcase comprehension and interpretation by explaining ideas, summarizing concepts, and making predictions. As learners ascend to the "Applying" level, they apply acquired knowledge and skills in new or unfamiliar situations, involving problem-solving and procedural implementation. The "Analyzing" level requires learners to break down complex information, identify patterns, and make connections, organizing and categorizing elements. At the "Evaluating" level, critical assessment and decision-making come into play as learners evaluate information, arguments, or hypotheses based on specific criteria. They assess, critique, justify, and prioritize various elements. Finally, at the pinnacle, the "Creating" level demands originality and creativity. Learners at this stage generate new ideas, design innovative solutions, invent novel approaches, and integrate knowledge and skills to produce unique outcomes.

The updated taxonomy equips educators with a versatile instrument for crafting instructional strategies, creating assessments, and cultivating higher-order thinking skills in students. Emphasizing action-oriented verbs linked to each level, it underscores the dynamic aspect of learning and the practical application of knowledge. Furthermore, the incorporation of the knowledge dimension acknowledges diverse types of knowledge essential for different cognitive processes. In essence,



the revised Bloom's Taxonomy urges educators to involve students in purposeful and stimulating learning

encounters, nurturing profound comprehension, critical reasoning, and inventive problem-solving capabilities.

REMEMBER	UNDERSTAND	APPLY	ANALYZE	EVALUATE	CREATE
This involves recalling information without necessarily understanding it.	Comprehending information by interpreting, summarizing, or explaining	Applying acquired knowledge in new situations or solving problems.	Breaking down information into parts and understanding relationships.	Making judgments based on criteria and evidence.	Synthesizing information to generate new ideas or products.
<b>Example Action Verbs:</b> List, Define, Recall, Identify, Memorize	<b>Example Action Verbs:</b> Explain, Summarize, Paraphrase, Describe, Interpret	<b>Example Action Verbs:</b> Apply, Solve, Use, Demonstrate, Illustrate	<b>Example Action Verbs:</b> Analyze, Compare, Contrast, Differentiate, Examine	<b>Example Action Verbs:</b> Evaluate, Assess, Judge, Critique, Prioritize	<b>Example Action Verbs:</b> Evaluate, Assess, Judge, Critique, Prioritize
<i>Example:</i> Recall the names of the capital cities in Europe.	<i>Example:</i> Summarize the main ideas of a historical speech.	<i>Example:</i> Apply knowledge of grammar rules to edit a paragraph for clarity.	<i>Example:</i> Analyze the motives of characters in a novel.	<i>Example:</i> Evaluate the ethical implications of a decision in a case study.	<i>Example:</i> Create a multimedia presentation to showcase the impact of climate change on ecosystems.

Figure 2. Blooms Taxonomy

**Develop Course Outcomes (CO)**

The general guidelines for writing course outcomes as follow.

- o Use Action Verbs: Use explicit and quantifiable action verbs, including analyze, evaluate, demonstrate, apply, create, and compare, while crafting Course Outcomes (COs) to accurately articulate anticipated student learning and accomplishments. You may emphasize these action verbs within your course outcomes, as illustrated in Table 1, or assign a numerical prefix starting from 1 to each CO for clarity.
- o Cover Different Cognitive Levels: Ensure COs span various cognitive levels, drawing from Bloom's Taxonomy, to engage students in diverse thinking processes like remembering, understanding, applying, analyzing, evaluating, and creating.
- o Be Achievable: Craft COs that are realistic and attainable within the course's timeframe, considering the course level, student backgrounds, abilities, and available resources.
- o Be Measurable: Design COs that are observable and measurable, facilitating progress assessment

through appropriate evaluations. Avoid the use of two action verbs, like "Differentiate and Analyze," and reframe as needed.

- o Count: Aim for a preferable range of 4-6 Course Outcomes for a 4-credit course.

Illustrating these principles, a case study explores a Computer Science& Engineering program, aligning COs with the Revised Bloom's Taxonomy. The outcomes, represented in Table 1 for the Machine Learning subject, exemplify how action verbs and corresponding RBT levels structure and assess cognitive complexity. Note that actual COs may vary based on specific course objectives. This approach not only enhances learning experiences but also aligns with the educational objectives of providing quality and inclusive education, as emphasized by SDG 4.

Table 1. Examples of well-written course outcomes

Upon completion of this course, students will be able to	
PCC-CS 604.1	ExplainMachine Learning concepts.
PCC-CS 604.2	Analyzethe Machine Learning model
PCC-CS 604.3	Design solution using Machine Learning techniques.

PCC-CS 604.4	Apply Machine Learning concepts and methods to find solution to real-world problems in domain of data mining, information retrieval, computer vision, linguistics and bioinformatics, etc.
--------------	--

This synchronization plays a pivotal role in ensuring that upon graduation, students possess the requisite skills and knowledge either to seamlessly enter the workforce or pursue further education. Program-specific outcomes are uniquely tailored to each program's focus. For instance, an engineering program might emphasize outcomes related to designing and constructing structures. When course outcomes align with these program-specific objectives, it signifies that the courses are effectively contributing to students attaining the program's core goals. This strategic alignment safeguards that students graduate with the necessary expertise to excel in their chosen field.

**Mapping CO's with PO's and PSO's**

Aligning course outcomes with program outcomes and program-specific outcomes is crucial to guarantee that students acquire the essential skills and knowledge for success in their chosen field. The alignment signifies that courses are meticulously designed to aid students in accomplishing the overarching goals of the program.

**Table 2. Sample CO-PO-PSO Mapping**

CO	PO1	PO2	PO3	PO4	PO5	PO6	PO7	PO8	PO9	PO10	PO11	PO12	PSO1	PSO2
PCC-CS 604.1	3	3	3	2	2	-	-	-	-	-	-	-	3	2
PCC-CS 604.2	3	3	2	3	3	-	-	-	-	-	-	-	3	2
PCC-CS 604.3	2	3	2	3	3	-	-	-	-	-	-	-	3	2
PCC-CS 604.4	2	3	3	3	2	2	-	-	-	1	-	-	3	3

Above Table 2. shows the correlation matrix of Course Outcomes with Programme Outcomes (CO-PO) for the courses PCC-CS604.1, PCC-CS604.2, PCC-CS601.3, and PCC-CS601.4 The correlation matrix shows the level of correlation between each course outcome (CO) and each program outcome (PO). A correlation of 1 indicates a strong correlation, a correlation of 2 indicates a medium correlation, and a correlation of 3 indicates a low correlation. With this mapping we can identify courses essential for students to learn the skills and knowledge that they need to be successful in their chosen field.

**Justification of Mapping of Course Outcomes with Program outcomes**

The basis behind aligning course outcomes with program outcomes and program-specific outcomes

is to guarantee that students acquire the necessary skills and knowledge for success in their chosen field. This alignment allows us to discern how each course contributes to the overall learning objectives of the program. This strategic mapping ensures that students do not enroll in irrelevant courses and, instead, derive maximum value from their educational experience. Program-specific outcomes are tailored to a specific program or field of study. For instance, a computer science program might include outcomes related to designing and developing software, utilizing computer science techniques to analyze and solve problems, and effectively communicating about computer science concepts. The accompanying image provides a sample illustration of the justification for aligning course outcomes with program outcomes (CO-PO).

**Table 3. Sample CO-PO Justification**

Course Code	Justification
PCC-CS604.1	An in-depth knowledge of mathematics and engineering is required to understand the basics of Machine Learning. (PO1). Only with the fundamentals learnt, problems in the field of Artificial Intelligence can be analyzed and find solutions through ML tools (PO2, PO3, PO4 & PO5).
PCC-CS604.2	A good mathematical and engineering fundamental is required to describe Machine Learning process (PO1) and hence formulate problems on Machine Learning (PO2). By describing ML processes, analyzing given data (PO3) and thereby develop a model (PO4) to find solutions using advanced tools (PO5), can be done.
PCC-CS604.3	A moderate Engineering and mathematical background are essential to assimilate various types of Python libraries (PO1). With the knowledge assimilated, problems related to given data and thereby designing solution, through ML algorithms can be done (PO2, PO3, PO4 & PO5).
PCC-CS604.4	A moderate mathematical and engineering fundamental is required to apply ML concepts (PO1) and hence formulate problems on given data (PO2& PO3). Applydata ML concepts and methods to find solution to real-world problems and communicate these solutions effective with ensure the responsible use of data to benefit society (PO4, PO5 & PO6)

Similarly, a well written proper justification is needed for CO-PSO mapping also.

**Decide CO Assessment Tools**

Two primary categories of assessment tools, namely Direct and Indirect, are employed to gauge the achievement of course outcomes. Direct assessment tools, exemplified below, directly evaluate students' knowledge, understanding, and application of course content:

- o Exams and quizzes assess theoretical knowledge, understanding, and problem-solving abilities.

Performance assessments, such as projects, presentations, simulations, or case studies, enable students to demonstrate skills in real-world contexts.

- o Practical assessments involve hands-on activities, laboratory experiments, or fieldwork to test the application of theoretical knowledge.
- o Observations include direct scrutiny of students' performance in class, discussions, or group activities to evaluate participation, engagement, and interpersonal skills.

In contrast, examples of Indirect Tools, which provide insights through external perspectives, are outlined below:

- o Surveys and questionnaires gather feedback from students, alumni, or employers regarding the perception of course outcome attainment and curriculum effectiveness.
- o Interviews and focus groups collect qualitative data from students, faculty, or stakeholders to gain insights into their experiences and suggestions related to course outcomes.
- o Self-assessment tools, like questionnaires or rubrics, enable students to reflect on their learning, skills, and progress.
- o Course evaluations involve standardized forms or online platforms to gather student feedback on various course aspects, including course outcome attainment.
- o Program-level assessments analyze student performance data, graduation rates, or institutional data to infer course outcome attainment at the program or institutional level.

To calculate Course Outcome (CO) attainment, the paper proposes a simple common assessment tool outlined in Table 5, emphasizing the importance of aligning assessment tools with the nature of course outcomes and the desired level of evaluation. The proposed method assigns a 75% weightage to direct assessment, covering Continuous Internal Evaluation (CIE), Practicals/Tutorials, and University/Semester End Examinations, and a 25% weightage to indirect

assessment, implemented through the Course Exit Survey. This comprehensive approach, incorporating both direct and indirect assessment tools, enhances the understanding of students' learning and course outcome attainment.

**Table 5. Basic Assessment Tools**

Direct (75 %)			Indirect (25 %)	
Tools	Assessment	Assessment Cycle	Tool	Assessment Cycle
CIE- I	Internal	One class test per semester	Course Exit Survey	One per semester
CIE- II	Internal	Second class tests per semester		
Practical's	Internal	Once in a Week		
University Exam	External	One per semester		

**Setting threshold and CO Target**

The course outcomes attainment performance framework encompasses threshold levels, attainment parameters, and target attainment, providing a methodical approach to assess student performance in alignment with a course's learning outcomes. Threshold levels set the minimum performance standards that students are expected to meet, serving as benchmarks for satisfactory understanding and competency. Determined based on factors like the institute's age, student quality, and academic offerings, these levels establish a baseline. Attainment parameters specify the desired percentage of students meeting or exceeding the threshold, offering a gauge of success in achieving learning outcomes. Target attainment signifies the specific performance goal set for students, guiding efforts to reach a desired level of achievement. This framework aids educators in evaluating teaching methods, curriculum design, and assessments, fostering continuous improvement in course outcomes attainment. An example illustrating the establishment of thresholds and CO targets is provided below.

**Table 6. Basic Example for Setting Threshold & CO Target**

Attainment	Parameter
3.0	86-100% student score more than 40% marks (Direct + Indirect) for CO

2.0	71-85% student score more than 40% marks (Direct + Indirect) for CO
1.0	55-70% student score more than 40% marks (Direct + Indirect) for CO
<b>Target Attainments</b>	
2.0	71-85% student score more than 40% marks (Direct + Indirect) for CO.

The example provided in Table 6 establishes the threshold and CO target for course outcomes attainment. Threshold levels, denoted as 3.0, 2.0, and 1.0, delineate varying ranges of student performance, with higher levels indicating greater performance expectations. Attainment parameters, ranging from 86-100% for a threshold of 3.0, 71-85% for 2.0, and 55-70% for 1.0, specify the percentage of students expected to exceed the 40% threshold in assessments for each course outcome. The target attainment level is set at 2.0, aiming for 71-85% of students to surpass the 40% threshold. This targeted approach facilitates the assessment of course outcomes achievement, highlighting areas for improvement and continuous enhancement in teaching and assessment strategies to meet students' learning objectives.

**CO attainment Calculation**

The CO Assessment process involves several steps. Initially, course outcomes are evaluated through Continuous Internal Evaluation (CIE), University/Semester End Examination, Practicals/Tutorials, and Course Exit Survey to analyze the attainment levels of COs. Subsequently, student performance is calculated based on the achievement of a threshold value (above 40%) in both direct and indirect assessments for each course outcome. The attainment of COs for individual courses is determined by averaging across all Direct Assessment Tools and Indirect Assessment Tools addressing individual COs.

The overall CO attainment is then calculated by taking 75% of the average direct attainment and 25% of the average indirect attainment using below formula as shown in Figure 3.

CO Attainment=(Average of Direct Attainment addressing individual CO×0.75)+(Average of Indirect Attainment addressing individual CO×0.25)

CO	Attainment CIE-1	Attainment CIE-II	Attainment Practical	Attainment SUK	Final Direct Attainment (A)	80 % of Direct (A)	Indirect Attainment	20 % of Indirect (B)	Final A+B
CO1	3		3	3	3	2.4	3	0.6	3
CO2	3		3	3	3.0	2.4	3	0.6	3.0
CO3	2	3	3	3	2.8	2.2	3	0.6	2.8
CO4		2	3	3	2.7	2.2	3	0.6	2.8

Figure 3. CO attainment calculation

Finally, the calculation of Program Outcomes (POs) or Program Specific Outcomes (PSOs) through a course involves summing the product of overall CO attainment and CO-PO mapping, divided by the sum of the Maximum PO Mapping Factor. The calculation

methodology is exemplified in the Figure 4, with the highlighted last row indicating the contribution of the specific course to PO attainment

$$\frac{\sum (\text{Overall CO attainment} \times \text{PO mapping factor})}{\sum (\text{Maximum PO Mapping Factor})}$$

PO		PO1	PO2	PO3	PO4	PO5	PO6	PO7	PO8	PO9	PO10	PO11	PO12	PSO1	PSO2
CO	Attainments														
CO1	3	3	3	3	2	2								3	2
CO2	3	3	3	2	3	3								3	2
CO3	2.8	1.9	2.8	1.9	2.8	2.8								2.8	1.9
CO4	2.8	1.9	2.8	2.8	2.8	1.9								2.8	2.8
Final PO Attainment		2.4	2.9	2.4	2.65	2.4	1.8				0.9			2.9	2.2

Figure 4. CO-PO-PSO attainment of the Course

Action plan for attained and unattained Course Outcomes

The evaluation of Course Outcomes (COs) through a methodical process, outlined in Figure 1, involves both Direct and Indirect Assessment tools. Post internal and external assessments, CO attainment is computed utilizing a predefined formula, with 75% weightage assigned to Direct Assessment Tools and 25% to Indirect Assessment tools. The achieved CO levels are then assessed against the established threshold for each CO. If the attainment surpasses the threshold, adjustments may be made for subsequent years to sustain a rigorous standard, fostering ongoing improvement and motivating students to aim for elevated levels of accomplishment.

CO2	2	2.2	0.2 +	YES	Will set new higher targets or attainment levels for next A. Y
CO3	2	2.5	0.5+	YES	
CO4	2	3	1+	YES	

However, in cases where the attainment falls below the established threshold, the course and module coordinators initiate essential measures to bridge the gap. This might include incorporating co-curricular activities, arranging supplementary classes or tutorials for all students, hosting expert lectures, and delivering remedial classes tailored to the needs of students requiring additional support. These interventions are designed to enrich student learning and promote the achievement of Course Outcomes (COs).

Table 8. Action Plan for Unattained Course Outcomes

Table 7. Action Plan for Attained Course Outcomes

Course outcome	Target	Attainment	Gap	Attained	Action Plan for Next Academic Year (A.Y)
CO1	2	3	1+	YES	

Course outcome	Target	Attainment	Gap	Attained	Action Plan for Next Academic Year (A.Y)
CO1	2	1	1-	NO	Conduct remedial classes



CO2	2	1.5	0.5-	NO	Organize Extra classes or Tutorials.
CO3	2	0.8	1.2-	NO	Organize Expert Lectures.
CO4	2	1	1-	NO	Conduct Co-curricular activities

By following this assessment process and taking appropriate measures based on the outcomes, educational institutions can continuously monitor and improve the attainment of COs. This iterative approach ensures that students are equipped with the necessary knowledge and skills, and any shortcomings are addressed to enhance the overall quality of education provided.

**CONCLUSION**

The process of crafting and achieving Course Outcomes (COs) involves a systematic approach integrating Program Outcomes (POs), Program Specific Outcomes (PSOs), and Revised Bloom's Taxonomy (RBT) levels. Effective assessment tools, including exams, assignments, and projects, are pivotal in evaluating CO attainment. This paper introduces a performance framework encompassing threshold levels, attainment parameters, and target attainment, facilitating a structured evaluation of student performance, aligning with the pursuit of Sustainable Development Goal 4 (SDG 4) - Quality Education. Establishing threshold levels as benchmarks enables the identification of satisfactory comprehension and competence in course materials. The assessment process combines direct and indirect assessment tools, with an 80-20 weighted distribution, aiding institutions in gauging the achieved CO levels against set thresholds. This comparative analysis empowers educational entities to gauge attainment levels, enabling strategic interventions for addressing gaps. These interventions encompass diverse approaches like co-curricular activities, supplemental classes, and personalized support for students requiring additional assistance.

This iterative process not only facilitates continuous monitoring but also ensures the enhancement of CO

attainment. By employing such an approach, institutions can consistently enhance and fine-tune educational practices, ensuring students acquire essential knowledge and skills while maintaining a challenging academic standard. Ultimately, this paper underscores the critical role of outcome-based education in advancing the quality of education within higher education institutions, directly contributing to the realization of SDG 4's vision of inclusive and equitable quality education for all.

**REFERENCES**

- Jandrić, Petar, Ana Fuentes Martinez, Charles Reitz, Liz Jackson, Dennis Grauslund, David Hayes, Happiness Onesmo Lukoko et al. "Teaching in the age of Covid-19—The new normal." *Postdigital Science and Education* 4, no. 3 (2022): 877-1015.
- Pereira, Diana, Irene Cadime, Gavin Brown, and Maria Assunção Flores. "How do undergraduates perceive the use of assessment? A study in higher education." *European Journal of Higher Education* 12, no. 1 (2022): 1-17.
- MacDonald, Laura, Evan Thomas, Amy Javernick-Will, Jesse Austin-Breneman, Iana Aranda, Carlo Salvinelli, Rita Klees et al. "Aligning learning objectives and approaches in global engineering graduate programs: Review and recommendations by an interdisciplinary working group." *Development Engineering* 7 (2022): 100095.
- Sugarman, Stephen D. "The Failed Quest for Equal Educational Opportunity: Regulating Education the Way We Regulate Business." *JL & Educ.* 50 (2021).
- Misbah, Zainun, Judith Gulikers, Wahyu Widhiarso, and Martin Mulder. "Exploring connections between teacher interpersonal behaviour, student motivation and competency level in competence-based learning environments." *Learning Environments Research* (2022): 1-21.
- Kushari, Berlian, and Lukman Septiadi. "A learning outcome assessment information system to facilitate Outcome-Based Education (OBE) implementation." *Jurnal Pendidikan Teknologi dan Kejuruan* 28, no. 2 (2022).
- Mukesh, S. "Outcome-based learning: an overview." In *Proceedings of the International Conference on Best Innovative Teaching Strategies (ICON-BITS 2021)*. 2022.
- Amirtharaj, S., G. Chandrasekaran, K. Thirumoorthy,

- and K. Muneeswaran. "A systematic approach for assessment of attainment in outcome-based education." *Higher Education for the Future* 9, (2022): 8-29.
9. Harden, Ronald M. "AMEE Guide No. 21: Curriculum mapping: a tool for transparent and authentic teaching and learning." *Medical teacher* 23, no. 2 (2001): 123-137.
  10. Joyner, Helen S. "Curriculum mapping: A method to assess and refine undergraduate degree programs." *Journal of Food Science Education* 15, no. 3 (2016): 83-100.
  11. Suresh. D. Mane S. P. Dodamani. "Measures for Improving Undergraduate Engineering Education: An Emperical Study in the state of Karnataka". *The International Journal Of Engineering And Science (IJES)*, Volume 4, Issue 4, PP 40-46 (2015). ISSN (e): 2319 – 1813 ISSN (p): 2319 – 1805.
  12. Erlinger, Allison. "Outcomes assessment in undergraduate information literacy instruction: a systematic review." *College & Research Libraries* 79, no. 4 (2018): 442.
  13. Farmer, Elizabeth A. "Faculty development for problem-based learning." *European Journal of Dental Education* 8, no. 2 (2004): 59-66.
  14. Sun, Poi Hun, and Sek Yan Lee. "The importance and challenges of outcome-based education-a case study in a private higher education institution." *Malaysian Journal of Learning and Instruction* 17, no. 2 (2020): 253-278.
  15. Syeed, MM Mahbulul, A. S. M. Shihavuddin, Mohammad Faisal Uddin, Mahady Hasan, and Razib Hayat Khan. "Outcome based education (OBE): Defining the process and practice for engineering education." *IEEE Access* 10 (2022): 119170-119192.
  16. Suresh. D. Mane, "Accreditation of UG Engineering Programmes in India: Enhanced Role of Teaching Fraternity." *International Journal of Scientific Engineering and Applied Science (IJSEAS)* - Volume-1, Issue-6, September 2015, ISSN: 2395-3470.
  17. Suresh. D. Mane, "NBA and NAAC Accreditation of UG Engineering Programmes/Colleges in India: A Review". *International Journal of Scientific Engineering and Applied Science (IJSEAS)* - Volume-1, Issue-6, September 2015, ISSN: 2395-3470.

# Empowering the Slow Learners to Enhance basic Concepts of Mathematics for Quality Education According to Sustainable Development Goal 4

## Ranitai Sachin Patil

Lecturer  
DIET  
Kolhapur, Maharashtra  
✉ ranip1922@gmail.com

## Vidyanand Sambhaji Khandagale

Asst. Professor,  
Department of Education  
Shivaji University  
Kolhapur, Maharashtra  
✉ vidyanandkhandagale@gmail.com

## ABSTRACT

This study is conducted a systematic review to empower the slow learners to enhance basic concepts of Math for quality education. Quality education is demand to prepare students for 21st century. Government of India implemented various programs for the quality education in the country. 4th sustainable development goal aims to ensure inclusive and equitable quality education for all. Study says teachers need to enhance basic concepts of mathematics for quality education. Here the researcher want to focus the children who are at below basic and basic levels. Organizing students by competencies and distributing personalized instructions across the students will help the teachers in rapid improvement of students learning and quality education goal of SDG will be achieved. Teacher can evaluate the children and grouped by what content they had completed, tough and neglected content also. Using the data, teacher can reorganize the personalized teaching strategy. Use of educational technology tools for instructional model will help the teacher in making interactive class, where students can learn with their learning styles, pace and speed etc.

## INTRODUCTION

Quality education is the demand to prepare the students for 21st Century. It determines how much and how well children learn and extent to which their education percolates into the range of personal, social and developmental benefits to themselves and the nation. There are numerous meaning of quality education. Regarding better learners the learning environment, the content and classroom procedures, learning outcomes and child based evaluation is considerable.

Government of India implemented various programs for the quality education in the country. National education policy 1986 had underscored the constitutional resolve to provide quality education to all. National curriculum framework (NCF) 2005 also emphasizes on the need of improvement in quality of elementary education. The 86th amendment Act which took the form of RTE in 2009 made education as fundamental right for all

children within the age group of 6 – 14 years. It gives right of quality and equitable elementary education to every child.

SSA (Sarva Shiksha Abhiyan reformed as Samagra Shiksha Abhiyan) helped in universalization of quality of elementary education. The country has almost achieved the target of universal access and betterment of students learning. For monitoring the quality of education along with NGO, Government is conducting various assessments and surveys like NAS( National Achievement Survey), ASER, SLAS( State Achievement Survey) etc. the survey reports shows the achievement of students in Mathematics.

NAS 2021 report highlights following readings

- The national average percentage of students for class third was 59%, which declined by 10% to 49% in class fifth.

- It further declined to 41.9% in class eight and then 37.8% in class 10.
- The performance recorded a decline in almost all subjects.
- For instance, the mathematics score nationally was 57% in class third, dropping by almost 10% to 44% in fifth, and to 36% in class eighth, and 32% in class 10th.

ASER report highlights following readings.

- There has been a decline in the basic reading and arithmetic skills of young children in Class 3 and Class 5 in India.

Parameters	2018	2022
Children in Std III who are able to at least do subtraction	28.2%	25.9%
Children in Std V across India who can do division	27.9%	25.6%

The survey reports signifies unravel the gaps in learning. It emphasizes the need of developing the short-term, mid-term and long-term interventions to improve the learning levels of students. Also the need of diagnosing a systematic understanding of the consequences that prolonged closure of schools has had on the learning of students in terms of their socio-emotional and cognitive development.

The 4th sustainable development goal aims to ensure inclusive and equitable quality education and promote lifelong learning opportunities for all. This goal supports the reduction of disparities and inequalities in education, both in terms of access and quality. The target 4.1.1 focuses (a) in grade 2/3; (b) at the end of primary and (c) at the end of lower secondary achieving at least a minimum proficiency level in i) reading and ii) mathematics. (UNISEF). Many children worldwide do not have foundational numeracy skills. As measured by the median across 35 countries and regions with data available, only one in every ten children had foundational numeracy skills.

There are several reasons why students may experience low achievement in mathematics at the elementary level. These reasons can be categorized into five divisions: student-related factors, teacher-related factors, curriculum-related factors, school-related factors, and

family-related factors. Student related factors includes math anxiety, lack of motivation, poor study habits, and learning difficulties. Whereas teachers related factors includes inadequate teacher training, poor teaching methods and lack of teachers support. (Yousef, 2019). One of the main reasons is Low proficiency in listening comprehension is a key factor in low proficiency in mathematics. Other factors include support decisions, second language status, and negative attitudes. (Metsamuuronen, Ukkola, 2022). The study identified the difficulties of teaching and learning mathematics in primary schools, particularly in grades one to three. It emphasizes the need for teachers to improve their experience and the mathematics curriculum to address these difficulties. The study recommends that mathematics teachers update their teaching methods by incorporating modern mechanisms, new technology, and tools to enhance the learning process. (Shwan, Shastri, Wakil, Bakhtyar, 2019).

Introducing non-typical methods in Math's lessons can be effective. Grouping students and personalizing tasks can increase motivation and success. Grouping students based on their learning styles and abilities and using problem-oriented activities can increase motivation. (Vinkler, 2020). The study emphasizes that teaching strategies should be organized for the group of students with same abilities. It's nothing but personalization of learning.

Personalized education refers to the adaptation of instruction to a specific learner and is juxtaposed with "traditional" instruction that is targeted at entire groups of learners. By changing the mode, content, or rate of instruction in accordance with some characteristic of the learner, it is suggested that individual shortcomings of learners can be addressed and their resources leveraged (Dockterman, 2018). The authors proposed a personalized learning model for teaching mathematics by means of interactive shorty stories to improve the quality of educational results of schoolchildren, and the importance of considering individual characteristics and goals in the learning process. The AXMA Story Maker application is mentioned as a personalized learning tool used for in the research. (Elena V. Soboleva, 2022)

Several studies have explored the effectiveness of personalized instruction strategies in enhancing

elementary students' understanding of basic mathematical concepts. Ross and his colleagues Deborah McCormick, Nancy Krisak, Padma Anand examined personalizing context in teaching mathematical concepts. The findings of paper shows that the The strategy of adapting the context of instructional material to students' backgrounds and interests, implemented through teacher management, resulted in consistently favorable achievement and attitude outcomes for treatment groups compared to control groups. The culmination of the research led to the development of a computer-assisted model to increase the strategy's practicality and sensitivity to learner differences. (Steven M. Ross, 1985).

E. Gibb found that individualizing instruction in mathematics education involves allowing students to progress at their own pace and style of learning, while also motivating them to think creatively in formulating mathematical concepts and knowledge. This approach aims to cater to each student's unique needs and readiness to advance in their mathematical understanding. Instruction provides ways to teach a group of students so that each pupil can take what is for him the "next step" in his development of mathematical understandings and competencies at the time when he is ready to move ahead. Individualizing instruction requires developing ways to permit the student to progress at his own rate according to his own style of learning and ways to motivate him to think creatively in formulating his mathematical concepts and knowledge of mathematics. In the field of elementary education, selected headlines relevant to the concern (E.Gibb, 1970) Wolfgang Schoppek, M. Tulis through their study of Enhancing Arithmetic and Word-Problem Solving Skills Efficiently by Individualized Computer-Assisted Practice found that Individualized practice led to large improvements in arithmetic skills and problem solving, which were sustained even after a follow-up period of 3 months, when intervention involving individualization of practice using adaptive training software was provided. (Wolfgang Schoppek, 2010).

Ningwei Sun, Kedong Li, Xuefang Zhu in their Action Research on Visualization Learning of Mathematical Concepts under Personalized Education Idea: Take Learning of Geometrical Concepts of Elementary

Math for Example, provides the visualization learning activities proposed in the paper were applied to learning geometrical concepts of elementary mathematics. The evaluation results showed that the visualization learning of elementary mathematics can improve learning abilities. The intervention in this study is the implementation of visualization learning activities based on learning activity theory, including situation, thinking, interaction, lucubration, and evaluation. (Ningwei Sun, 2016).

J. Bradley, Charles E. Notar, Donna Herring, Charlotte King Eady in their research paper Teaching Mathematics to Elementary School Students Using a Variety of Tools found that various instructional strategies in improving students' understanding and appreciation for mathematical operations, as well as the summary of proven instructional techniques for teaching mathematics in elementary school. (J. Bradley, Charles E. Notar, Donna Herring, Charlotte King Eady, 2009).

G.Albano, Sergio Miranda, A. Pierri in their 'Personalized Learning in Mathematics' research paper found that an innovative solution for enhancing predisposition to mathematics through personalized learning objectives and the integration of Wolfram Mathematics with the learning platform IWT. (G. Albano, Sergio Miranda, A. Pierri, 2014). The paper 'A Mathematical Educational Game Application for Primary School Slow Learner' focuses Educational games that focus on mathematics for slow learners are rarely found. The main findings of the paper are the successful development of an educational game for primary school slow learners focusing on mathematics and the positive feedback from both students and teachers regarding its effectiveness in improving understanding of mathematics subjects. (Kamarulzaman, Phon, Baharuddin, 2021).

Researchers have offered two theory-based explanations for the effectiveness of personalized instruction in studies where it has yielded better results than non-personalization. One is that students' greater familiarity with personalized problem situations and content may enable them to solve problems more easily by reducing their cognitive load. (Lopez, Sullivan, 1992). Study suggested that simply stating test items in personalized form might yield significantly better performance on them, irrespective of whether students receive



personalized instruction or not. If that is the case, student performance on mathematics tests generally may be improved by using contexts on the test items that are personalized, or at least familiar to most students. (Ku, Sullian, 2000). 'My Math Academy' significantly improved math learning outcomes and engagement, particularly for students with lower math knowledge at pre-school to 2nd grade students. (Bang, Li, Flynn, 2022)

To motivate students to learn math effectively, teachers can use transformational teaching, engage and encourage students, and provide opportunities for growth. Additionally, teachers can help students develop more confidence in math by connecting the math they're learning to real-life situations, using visual aids and activities to differentiate individual student needs, and encouraging student choices to show their understanding.

During the academic school visits when discussed with teachers, parents, it is recognized that children come to school having acquired different knowledge and skills. Some students may have been taught at home to count, to do math; others may have little informal instructions. In the school some of these learned quickly, while others progress more slowly. For such children teachers should design instructional sequences and then place each child in his appropriate place along each learning progression. Some of them may be at below basic level, some at basic, some at proficient and some may be at advanced level. Here the researcher want to focus the children who are at below basic and basic levels.

Organizing students by competencies and distributing personalized instructions across the students will help the teachers in rapid improvement of students learning and quality education goal of SDG will be achieved.

Teacher can evaluate the children and grouped by what content they had completed, tough and neglected content also. Using the data, teacher can reorganize the personalized teaching strategy.

Use of educational technology tools for instructional model will help the teacher in making interactive class, where students can learn with their learning styles, pace and speed etc. Personalized instruction is a powerful approach that tailors education to the unique needs,

strengths, and interests of individual students. The personalized learning strategy will include customized learning path that adapts the individual's need, with flexibility in activities, content to meet students need and ensuring no one is left behind. Beyond academics personalized learning considers the social-emotional growth, character development and life skills as students will work in collaboration, and problem solve and communicate effectively.

## CONCLUSION

The goal of sustainability is to ensure inclusive and equal high- quality education for all. According to the study, teachers must improve the basic concepts of mathematics to ensure quality education. Government of India has implemented various programs to promote quality education in the country. Organizing students by expertise and personalized instruction helps teachers.

## REFERENCES

1. Bang, Li, Flynn, H. J. (2022). Efficacy of an Adaptive Game-Based Math Learning App to Support Personalized Learning and Improve Early Elementary School Students' Learning. *Early Childhood Education Journal*.
2. Dockterman, D. (2018). Insights from 200+ years of personalized learning. *npj science of learning*.
3. E.Gibb. (1970). Through the Years: Individualizing Instruction in Mathematics. *The Arithmetic Teacher*.
4. Elena V. Soboleva, T. N. (2022). Development of the Personalized Model of Teaching Mathematics by Means of Interactive Short Stories to Improve the Quality of Educational Results Of Schoolchildren. *European Journal of Contemporary Education*.
5. G. Albano, Sergio Miranda, A. Pierri . (2014). Personalized Learning in Mathematics. *International Conference on Intelligent Networking and Collaborative Systems*.
6. J. Bradley, Charles E. Notar, Donna Herring, Charlotte King Eady. (2009). Teaching Mathematics to Elementary School Students Using a Variety of Tools. *Asian Social Science*.
7. Kamarulzaman,Phon,Baharuddin, N. B. (2021). A Mathematical Educational Game Application for Primary School Slow Learner. *International Conference on Software Engineering & Computer Systems and 4th*

- International Conference on Computational Science and Information Management (ICSECS-ICOCSIM).
8. Ku, Sullian, H.-Y. J. (2000). Personalization of mathematics word problems in Taiwan. Educational Technology Research and Development .
  9. Lopez, Sullivan, C. L. (1992). Effect of personalization of instructional context on the achievement and attitudes of hispanic students. Educational Technology Research and Development .
  10. Metsamuuronen, Ukkola, J. (2022). Rudimentary stages of the mathematical thinking and proficiency.
  11. Ningwei Sun, K. L. (2016). Action Research on Visualization Learning of Mathematical Concepts Under Personalized Education Idea: Take Learning of Geometrical Concepts of Elementary Math for Example. ICBL.
  12. Shwan, Shastri, Wakil, Bakhtyar, H. (2019). The Difficulties of Theoretical and Applied Learning for Mathematics Subject in Primary Schools. International e-Journal of Educational Studies.
  13. Steven M. Ross, D. M. (1985). Personalizing context in teaching mathematical concepts: Teacher-managed and computer-assisted models. ECTJ.
  14. UNISEF. (एन. डी.). Quality education, Grade-appropriate education for all boys and girls.
  15. Vinkler, L. (2020). Alternative tools for motivating young primary school students when learning maths. Journal of Process Management. New Technologies (CEES).
  16. Wolfgang Schoppek, M. T. (2010). Enhancing Arithmetic and Word-Problem Solving Skills Efficiently by Individualized Computer-Assisted Practice. The Journal of Educational Research.
  16. Yousef, A. A. (2019). Reasons and Suggested Solutions for Low-Level Academic Achievement in Mathematics. International e-Journal of Educational Studies 3(6):181-190.

# Harnessing Educational Technology Leadership for the 5<sup>th</sup> Industrial Revolution in Teacher Education Using the Kouzes and Posner's Model

## Queen Hlakanyane

Research Scholar  
Department of Education  
Shivaji University  
Kolhapur, Maharashtra  
✉ hlakanyanequeen@gmail.com

## Pratibha. S. Patankar Vidyanand. S. Khandagale

Chetna P Sonkamble  
Department of Education  
Shivaji University  
Kolhapur, Maharashtra  
✉ pratibhapatankar@gmail.com  
✉ vsk\_edu@unishivaji.ac.in

## ABSTRACT

*The 5th Industrial Revolution brings to the world opportunities and challenges of education in general, including teacher education. This calls for a paradigm shift in leadership and teacher preparation. In this regard, educational technology leadership arises as a vital framework for assisting and guiding leaders in education through this age of drastic change and advancement in technology. The paper attempts to argue that the Kouzes and Posner's model of The Five Practices of Exemplary Leadership can be used to harness educational technology leadership for a successful integration of 5IR technologies in teaching and learning. It explores the application of the model's five practices, which are; modelling the way, inspiring a shared vision, challenging the process, enabling others to act, and encouraging the heart, by leaders, in order to successfully integrate the 5th technology in teaching and learning in teacher education. Once this technology is successfully integrated in teaching and learning, teacher education institutions will not only produce teachers, but graduates who are well equipped with skills needed for the new generation.*

**KEYWORDS** : Educational technology leadership, Kouzes and Posner's model, 5<sup>th</sup> IR, Integration, Teaching and learning.

## INTRODUCTION

Scratch the surface of an excellent school and you are likely to find an excellent principal. Peer into a failing school and you will find weak leadership (Leithwood, K. A., & Reihl, 2003, p. 1). Technology leadership or educational technology leadership integrates different leadership techniques and strategies needed to assist educators utilise technology to upgrade instructional techniques in the classroom (Schmeltzer, 2001, as cited in Okeke & Dike, 2019). Empirical evidence indicates that educational technology leadership skills are essential for the successful integration of technology in teaching and learning. However, the fact is that educational technology leadership is a new field (Dai et al., 2020). Educational technology

leadership is practiced mostly in developed countries; hence educational technology leadership research is only well established in developed countries. Since there is empirical evidence that educational technology leadership is essential for the successful integration of technology in teaching and learning, it would be crucial to harness educational technology leadership through the Kouzes and Posner's model.

Leadership has significant impact on students' learning, as a second factor to the impact of quality of curriculum and teachers' instruction (Leithwood, K. A., & Reihl, 2003). As technology is becoming a need in teaching and learning in all educational institutions, leaders in educational institutions will have to revise their roles as educational technology leaders. The challenges that

are faced by schools, hence educational institutions, are not only attributed to lack of e-learning resources or computer amenities. The challenges include the culture of the organization, the leaders' behaviour and attitude, the preparedness of the staff members and leaders of the organisation, and their resistance to change (Hung, 2016; Jameson, 2013, as cited in Chua & Chua, 2017). This could be argued that if the educational institutions are faced with multiple and complex challenges in integrating technology in teaching and learning, it could mean that harnessing leadership through a particular model can bring a remarkable change, hence influence the successful integration of technology in teaching and learning.

## LITERATURE REVIEW

### The role of education in preparing students for the 5IR revolution

Barrot(2022) argues that for education to transition to 5IR, there is a need to have educational revolutions that would deal with the demands of an ideal society, which can be attained through the 5.0 Curriculum; a curriculum that conforms to the need of future jobs and 5IR atmosphere. It is a curriculum that is described as the one that directs; policy makers, developers of academic materials, school leaders, educators, organizations and academic agencies, and other core stakeholders in accomplishing academic milestones. However, achieving this milestone may require competent leaders that are skilled and knowledgeable.

Barrot(2022b) proposed a curriculum that is innovative in order to meet the demands of the 5IR context, which is the LC5. LC5 is a curriculum that aims at nurturing communicators who are competent and ready for the 5IR innovative environment. The core attributes of the LC5 include the following; community and socially oriented, technology focused, problem solving based, process directed, results oriented, diverse literacy, self-supervision self-sufficiency, adjustable and individualised curriculum. However, Barrot (2022b) asserts that while they advocate for the LC5 curriculum; readiness and determination of the key stakeholders is essential. This implies that the commitment and

readiness of the key people could call for those that are on leadership to act accordingly. Acting accordingly could mean applying the Kouzes and Posner's model in their leadership activities.

### The Kouzes and Posner's model

#### *Model the way*

Kouzes & Posner (2009) assert that for a leader to model the way, their guiding principles should be clear. The importance of clarity is that it enhances participation for both leaders and different stakeholders. When leaders show that they have a clear leadership philosophy, they declare to be 25% more committed to their work. Constituents who reveal that their leaders clearly defined their philosophy of leadership, indicate to be 40% more committed compared to those who do not. Constituents whose leaders have well defined leadership are positive and committed than those whose leaders do not own a well-defined leadership philosophy. Leaders who lead by example are more successful in their leadership more than those who do not. They cannot be successful by requesting people to commit to their work while they are not committed on their own. The leaders' actions need to align their actions with the organisation's shared values(Kouzes & Posner, 2013).

#### *Inspire a shared vision*

For leaders to successfully inspire their followers or the staff members in their organisations, they need to establish what they value in their organization, what motivates them, and where their inspirations are. Leaders need to utilize their previous experiences to determine the core values in their organizations. They need to be aware of what is happening in their organizations, especially things that are not moving according to expectations. They should invest time on thinking of what the future should be like concerning their vision. Leaders need to communicate with their constituents and determine what their dreams, aspirations, and hopes for the future are. The leaders are expected to reveal to their constituents how their long range inspirations are motivated by the vision of the organization. They need to encourage constituents' pride in the contributions they make towards achieving the common vision. Organization leaders are compelled

to share words, illustrations, models, representations, narrations, and examples of what they desire to transform their organization to. The leaders ought to be optimistic and zealous when communicating the future of their institutions (Madej, 2013).

*Challenge the process*

Successful leaders find creative and innovative ways to transform their organizations for the better. For leaders to challenge the process in a productive way, they need to be skilled. Such leaders are those that do not hesitate to take risks when they find opportunities that lead to success. Challenging the process includes assessing and interrogating the status quo instead of accepting the current setup. Employees are motivated to take risks in the same manner their leaders do. Successful leaders usually establish challenging targets that are higher than what the organization has already accomplished. They need to cultivate a culture of commitment on employees in order to reach their high organizational expectations and goals. This commitment should be supported by leaders in the organization (Kouzes & Posner, 2002, as cited in Uzochina & Oguegbu, 2015).

*Enable other to act*

Enabling others to act is about encouraging collaboration and empowering or strengthening other employees as a leader of an organisation. This may include the leaders motivating and empowering employees to make critical decisions concerning their goals in the organization. Salleh and Khalid (2018) found that leaders who encouraged collaboration among the employees automatically motivated the employees to accomplish impressive work. The same leaders distributed power among the employees, hence the followers felt capable, empowered, and devoted. When employees felt trusted, and granted an opportunity to be autonomous, they put more effort in their work and outperformed their expectations (Kouzes & Posner, as cited in Salleh & Khalid, 2018).

*Encourage the heart*

When motivation strategies are adopted as part of learning programs, education and training succeeds. When employees possess understanding and knowledge of what encourages them, they are likely to contribute towards achieving their goals and the organization goals

(McConnel, 2005, as cited in Stephenson, 2021). Leaders can encourage the employees’ hearts by having frequent meetings and motivational sessions in order to discuss the employee’ workload in order for the employee to plan for development of skills and other activities in the work place. The leaders may also encourage the heart by discussing, keeping record, acknowledging, and communicating the employees’ achievements. Leaders can engage in socialisation activities and learning in groups in order to create a collaborative community atmosphere. They can acknowledge and celebrate the employees’ achievements as a way of recognizing and appreciating the employees’ commitment (Stephenson, 2021).

**HARNESSING EDUCATIONAL TECHNOLOGY LEADERSHIP THROUGH THE KOUZES & POSNER’S MODEL**

**Modelling the way**

Leaders may start clearly communicating their vision to followers on what their philosophy is concerning the 5IR as far as teaching and learning is concerned. Leaders in learning institutions can utilize the 5IR technologies in their teaching and learning as a way of showing the employees or their followers the way. If employees witness the leaders in their educational institutions integrating the 5IR technologies in teaching and learning, they may feel motivated, encouraged and copy the example of their leader. Leaders can organize workshops, training sessions, and in-service training in order for employees to be trained on new trends related to 5IR technologies. Leaders can also educate employees in their organisations on the benefits and effectiveness of using 5IR technologies in their teaching and learning. This will help the employees to understand reasons for using 5IR technologies.

**Inspiring a shared vision**

Leaders are necessitated to effectively communicate their vision related to 5IR to relevant stakeholders, like parents, teachers, and students in order to create an atmosphere of mutual understanding and cooperation in achieving the organizational vision. They may engage faculty members in collaborative visioning sessions concerning the 5IR vision in teaching and learning. Leaders may also foster a shared sense of purpose



and direction; emphasizing the importance of aligning 5IR technology integration with educational goals. It is crucial for concerned stakeholders to share a sense of 5IR purpose in teaching and learning in order to encourage cooperation and assisting those that need to be strengthened.

**Challenging the process**

Leaders in learning institutions could examine existing pedagogical approaches in light with 5IR. They can ensure that the pedagogies accommodate 5IR to be integrated in teaching and learning. They may provide opportunities for experimentation and exploration of new 5IR technologies. They can do this by inviting resource people in their learning institutions, who have expertise in 5IR technologies so that stakeholders can be updated with the latest and operations of 5IR technologies. They may also collaborate nationally and internationally with other learning institutions so that they may share their experiences with the use of 5IR in teaching, and also learn from others. Leaders can identify and overcome the barriers to 5IR technology integration in teaching and learning, such as resistance, negative attitude, poor leadership and funding. They can develop their technology leadership skills through personal development and furthering their education in order to overcome those barriers.

**Enabling others to act**

Leaders may provide necessary resources to support the use of 5IR technology in teaching and learning. They can also provide training opportunities and professional development related to 5IR technologies. This can be ins-service training or 5IR related courses that develop employees to use 5IR technologies efficiently. Leaders can implement programs and initiatives that will encourage the employees to demonstrate the use of 5IR technologies and share knowledge related to 5IR use in teaching and learning. Leadership roles and duties related to 5IR programs can be distributed among employees in order for employees to take ownership of those 5IR technologies.

**Encouraging the heart**

Leaders may implement initiatives and programs that will encourage both collaboration, healthy

competition, and reward, that are related to the successful 5IR technologies integration in teaching and learning. They can own and implement initiatives and programs that include the celebration of targets achieved through 5IR technologies. Leaders may provide feedback from the use of 5IR technologies in teaching and learning, and evaluate the use of 5IR technologies in their teaching and learning in their learning institutions. They may implement strategies that promote appreciation and support whenever the employees have reached targets or goals related to 5IR technology.

**CONCLUSION**

The challenges of successfully integrating technology in teaching and learning vary from one educational institution to another, one community to another, one region to another, one country to another. Since leadership indirectly plays a crucial role in teaching and learning, the Kouzes & Posner’s model can be used to harness educational technology leadership for the successful integration of 5IR technologies in teaching and learning.

**RECOMMENDATIONS**

- Each educational institution can own and adopt a vision related to 5IR technologies.
- The vision should be explicitly elaborated, planned, documented, assessed, and evaluated.
- Educational institutions should own and implement initiatives and programs that support the 5IR technologies vision.
- Learning institutions can collaborate nationally and internationally on recent trends related to 5IR in education.
- There should be a policy that deals with employees’ training on 5IR technologies.

**REFERENCE**

1. Barrot, J. S. (2022a). International Handbook on Education Development in Asia-Pacific. International Handbook on Education Development in Asia-Pacific, November 2022, 0–15. <https://doi.org/10.1007/978-981-16-2327-1>

2. Barrot, J. S. (2022b). Language education. *International Encyclopedia of Education: Fourth Edition*, November 2022, 216–223. <https://doi.org/10.1016/B978-0-12-818630-5.03036-0>
3. Chua, Y. P., & Chua, Y. P. (2017). Developing a grounded model for educational technology leadership practices. *Egitim ve Bilim*, 42(189), 73–84. <https://doi.org/10.15390/EB.2017.6705>
4. Dai, H., Cheek, D., Officer, C. L., & Li, T. (2020). EXPLORING SYSTEMS THINKING IN SCHOOL PRINCIPALS' EDUCATIONAL TECHNOLOGY LEADERSHIP IN YUNNAN. 562–571.
5. Kouzes, J. M., & Posner, B. Z. (2013). *Great Leadership Creates Great Workplaces*. 2013, 2023. <https://play.google.com/store/books/details?id=5kFsAwAAQBAJ>
6. Leithwood, K. A., & Reihl, C. (2003). What do we already know about successful school leadership? AREA Division : A Task Force on Developing Research in Educational Leadership., January, 1–9. [http://olms.cte.jhu.edu/olmssful leadership](http://olms.cte.jhu.edu/olmssful%20leadership) and are valuable in almost all educational contexts. (4) Successful school leaders respond productively to challenges and opportunities created by today's accountability-oriented policy context. (5) Successful l
7. Madej, M. (2013). Brought to you by | CAPES.
8. Okeke, N. L., & Dike, H. I. (2019). Head Teachers' Technology Leadership Competencies and ICT Integration in Model Primary Schools in Rivers State. *International Journal of Innovative Information Systems*, 7(1), 14–21. [www.seahipaj.org](http://www.seahipaj.org)
9. Salleh, M. J., & Khalid, R. (2018). Effectiveness of Principals Exemplary Leadership Practiced on School Achievements: Stakeholders' Perceptions. *European Journal of Education Studies*, 5(1), 208–220. <https://doi.org/10.5281/zenodo.1410063>
10. Stephenson, M. (2021). Northumbria Research Link ([www.northumbria.ac.uk/nrl](http://www.northumbria.ac.uk/nrl)). *Academy of Management*, 51(September), 1–51.
11. Uzochina, G. O., & Oguegbu, A. (2015). Principals' Leadership Styles: a Kouzes and Posner Model Based Assessment of Principals' Leadership Practices. *African Education Indices*, 8(1), 1–18.

# Curriculum Mapping for Quality Education

**Sangita Sanjay Shinde**

Research Student  
Department of Education  
Shivaji University  
Kolhapur, Maharashtra

**Pratibha S. Patankar**

Prof & Head  
Department of Education  
Shivaji University  
Kolhapur, Maharashtra  
✉ paratibhaspatankar@gmail.com

## ABSTRACT

In the pursuit of fostering effective and meaningful educational experiences, the role of curriculum design becomes paramount. The paper explores the intricate connection between curriculum mapping and the delivery of quality education. As educational landscapes evolve, the need to align curriculum with the goals of a high-quality education system becomes increasingly apparent. This research delves into the theoretical foundations, practical applications, and potential impacts of curriculum mapping on enhancing educational quality. By investigating the interplay between curriculum mapping strategies and the attainment of quality education indicators.

This study aims to contribute valuable insights for educators, policymakers, and researchers seeking to optimize the educational journey for learners in diverse contexts and to explore the impact of curriculum mapping on attaining or sustaining quality education. This research paper serves as a clear indicator for readers regarding the subject and objectives of the study.

Objectives of this paper: 1. To explain the role of curriculum mapping in ensuring and enhancing the quality of education.

2. To identify gaps in the secondary biology curriculum through the mapping process.

**KEYWORDS** : Curriculum, Curriculum mapping, Quality education, etc.

## INTRODUCTION

In the pursuit of delivering a meaningful and high-quality education, curriculum mapping emerges as a crucial factor. The process involves deliberately planning and organizing educational content to guarantee students receive a comprehensive and impactful learning experience. This study explores the importance of curriculum mapping, with the goal of understanding its influence on ensuring educational quality. Through an examination of how curriculum mapping identifies gaps and improves the overall coherence of educational programs, we aim to gather insights that contribute to an enhanced and resilient educational framework. This inquiry not only seeks to refine our comprehension of curriculum design but also strives to cultivate an environment conducive to quality

education.

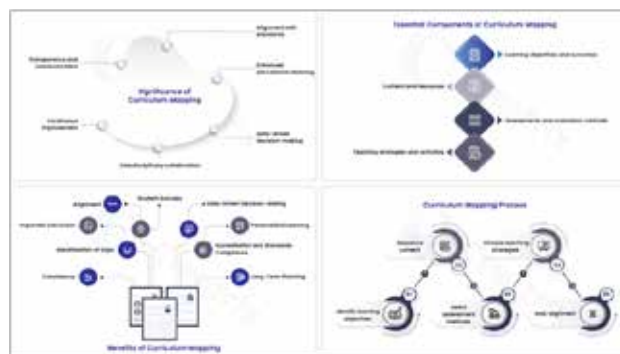

Source: <https://www.creatrixcampus.com>

### Objectives of this paper

1. To explain the role of curriculum mapping in ensuring and enhancing the quality of education.

- To identify gaps in the secondary biology curriculum through the mapping process.

## METHODOLOGY

The research method used in this paper relies on information from existing sources. We've used different reference books, articles, and online materials/ internet as our sources. The main technique applied is content analysis.

## REVIEW OF RELATED RESEARCH

Harden, R. M. (2001). "Curriculum mapping: a tool for transparent and authentic teaching and learning".

Uchiyama, K. P., & Radin, J. L. (2009). Curriculum mapping in higher education: A vehicle for collaboration. Innovative Higher Education.

Al-Eyd, & et. al. (2018). Curriculum mapping as a tool to facilitate curriculum development: a new School of Medicine experience.

Bone, E. K., & Ross, P. M. (2021). Rational curriculum processes: revising learning outcomes is essential yet insufficient for a twenty-first-century science curriculum. Studies in Higher Education.

Tanweer Alam, T. and Benaida, M., (2022), "Smart Curriculum Mapping and Its Role in Outcome-based Education".

This literature review guides the present study, shaping the formulation of strategies aimed at improving curriculum mapping practices and making a meaningful contribution to the broader discussion on quality education.

## CURRICULUM MAPPING

Curriculum mapping is a structured procedure that includes the strategic planning and documentation of content, skills, and assessments within an educational program. The objective is to generate a visual representation or map detailing what subjects will be covered, when they will be addressed, and how they align with educational goals and standards. Through this process, educators aim to guarantee that the curriculum maintains coherence, is systematically arranged, and efficiently facilitates student learning.

## The Curriculum Mapping Process

The curriculum mapping process involves five key steps to make sure that the education program fits well with the curriculum:

- Set Program Goals:** Educators need to figure out specific goals for the course they are mapping. This helps keep the curriculum focused on its intended path.
- Define Course Objectives:** Course objectives are the goals or achievements you want your students to reach by the end of the curriculum. It's essential that these objectives align with the overall goals set earlier.
- Collect Instructional Support Materials:** These are the materials that will assist students in reaching the course objectives. They could include textbooks, lesson plans, or other resources.
- Plan Formative Course Assessment:** These are tools and activities that help students evaluate their own progress. Formative assessments are like checkpoints during the learning journey.
- Plan Summative Course Assessment:** These assessments are more formal and are designed to measure overall student progress through the curriculum. They usually happen at the end of a course.

## The Importance of Curriculum Mapping

Curriculum mapping is essential for education as it aligns content with goals, maintains consistency, identifies gaps, optimizes resource utilization, aligns assessments, fosters collaboration, adapts to changes, improves the student experience, supports ongoing enhancement, and meets accreditation and accountability standards.

Various strategies are proposed for enhance curriculum mapping practices

No.	Various strategies	Objective	Curriculum Mapping Impact
1.	Clarifying Learning Objectives:	Ensure a clear understanding of what students are meant to learn.	Establish a solid foundation for mapping instructional activities and assessments to specific learning objectives.

2.	Aligning Assessments:	Ensure assessments accurately reflect targeted learning outcomes.	Provide a basis for evaluating the effectiveness of instructional strategies and maintain alignment with learning objectives.
3.	Integrating Technology:	Streamline the curriculum mapping process and facilitate efficient data management.	Enhance the accessibility and organization of curriculum maps, making it easier for educators to analyse and adjust instructional plans.
4.	Collaborative Planning:	Foster a collective and comprehensive approach to curriculum design.	Promote interdisciplinary connections and ensure a holistic curriculum that addresses various aspects of learning.
5.	Regular Review and Updates:	Ensure that the curriculum remains relevant and responsive to changing educational needs.	Support continuous improvement by allowing educators to adapt and refine curriculum maps based on ongoing assessments and feedback.
6.	Professional Development:	Equip educators with the knowledge and skills necessary for effective curriculum mapping.	Enhance the quality of curriculum mapping by empowering educators with up-to-date practices and methodologies.
7.	Data-Informed Decision Making:	Utilize data to make informed decisions about curriculum adjustments.	Enable educators to identify strengths and weaknesses in the curriculum, making it possible to tailor instructional strategies to better meet student needs.
8.	Student-Centred Approaches:	Focus on engaging and catering to diverse student needs.	Guide the development of curriculum maps that are responsive to different learning styles, ensuring a more inclusive and effective educational experience.
9.	Transparency and Communication:	Promote open communication and understanding among stakeholders.	Enhance collaboration and ensure that everyone involved in the educational process has a clear understanding of the curriculum goals and strategies.

10.	Feedback Loops:	Establish mechanisms for continuous improvement based on ongoing feedback.	Create a dynamic feedback loop that allows for timely adjustments to the curriculum, improving its relevance and effectiveness.
-----	-----------------	--	---

These strategies collectively contribute to the development, implementation, and continuous improvement of curriculum maps, fostering an educational environment that aligns with intended learning outcomes and meets the diverse needs of students.

Curriculum mapping for quality education involves some challenges, which can generally be overlooked. These challenges support the art journey of securing alignment of inspections, plans, and activities. Here are some challenges:

**Unclear Learning Objectives**

Challenge: Learning goals that are not clearly defined can make it difficult to plan the curriculum.

Impact: Matching teaching activities and tests with unclear goals becomes a challenge.

**Mismatched Assessments**

Challenge: Curriculum elements not aligning well with assessment methods.

Impact: Tests may not accurately measure what students have learned, affecting how well the curriculum is evaluated.

**Not Enough Use of Technology**

Challenge: Not making good use of technology tools for curriculum planning.

Impact: Managing and updating curriculum maps becomes hard, potentially leading to outdated information.

**Lack of Teacher Collaboration**

Challenge: Teachers and departments not working together enough.

Impact: It's tough to create a curriculum that flows well across subjects, resulting in a fragmented learning experience.

**Infrequent Reviews and Updates**

Challenge: Curriculum maps not getting reviewed and updated regularly.



Impact: Outdated content and teaching methods can hinder adapting the curriculum to meet changing educational needs.

### **Not Enough Teacher Training**

Challenge: Teachers not getting enough training in curriculum planning.

Impact: Teachers may struggle to implement and update curriculum maps, leading to less effective teaching.

### **Underutilizing Data for Decisions**

Challenge: Not effectively using data for making informed decisions.

Impact: It's hard to figure out what parts of the curriculum are working well and what needs improvement.

### **Ignoring Student-Centered Approaches**

Challenge: Neglecting to consider different learning styles and student needs.

Impact: Curriculum maps may not suit individual student needs, potentially resulting in disengagement and lower learning outcomes.

### **Lack of Transparency and Communication**

Challenge: Not enough communication and transparency among stakeholders.

Impact: It's difficult to make sure everyone involved understands the curriculum goals and strategies, hindering collaboration and support.

### **Limited Use of Feedback Loops**

Challenge: Not having ways to continuously get feedback and make improvements.

Impact: Issues in the curriculum may not be addressed promptly, making it hard to adapt to the evolving needs of students and educators.

To overcome these challenges, educational institutions, administrators, and teachers need to work together, emphasizing clear communication, ongoing professional development, and the effective integration of technology for successful curriculum mapping and quality education.

## **THE ROLE OF CURRICULUM MAPPING IN ENSURING AND ENHANCING THE QUALITY OF EDUCATION**

Curriculum mapping is very important to ensure the quality of education and it is done in several important ways:

- **Following Educational Goals:** Curriculum mapping makes sure that what is taught, the skills learned, and the tests given all match up with the main goals of education. This helps the whole education program have a clear purpose that fits with the school's overall mission.
- **Keeping Things Clear and Logical:** By organizing and planning the educational content in a systematic way, curriculum mapping ensures that students learn things in a clear and logical order. This avoids any confusion or unnecessary repetition, making sure students' progress smoothly.
- **Spotting Missing or Repeated Stuff:** Curriculum mapping helps teachers see where the lessons might be missing something important or where there might be too much repetition. This way, adjustments can be made to create a well-rounded and balanced curriculum.
- **Using Resources Wisely:** Teachers can use curriculum mapping to figure out the best way to use their time, materials, and staff. This makes sure there's enough support for effective teaching and learning.
- **Matching Tests with Learning Goals:** Curriculum mapping helps create tests that fit well with what's being taught. This ensures that the tests accurately show how well students are progressing and meeting their learning goals.
- **Working Together:** Teachers often work together when mapping the curriculum. This collaboration helps them understand the educational goals better and share ideas, leading to better teaching methods.
- **Adapting to Changes:** Since education is always changing, curriculum mapping gives a structured way to adapt to new standards, teaching methods, or other educational needs. This makes sure the

curriculum stays relevant and responsive.

- Making Learning Fun and Relevant: A well-mapped curriculum considers different ways students learn and makes lessons interesting. This improves the overall learning experience, making education more engaging and meaningful.
- Always Getting Better: Curriculum mapping is part of an ongoing process of making education better. Regular reviews and updates based on feedback help keep the curriculum effective and high-quality.
- Meeting Standards: Many schools use curriculum mapping to meet standards set by education authorities. This ensures that the school is delivering quality education that meets the necessary requirements.

Curriculum mapping ensures that what students learn aligns with goals, stays consistent, fills in any gaps, uses resources wisely, matches assessments with learning objectives, encourages collaboration among teachers, adapts to changes, makes learning enjoyable and relevant, supports ongoing improvement, and meets accreditation and accountability standards – all of which contribute to providing a high-quality education.

**Gaps in the secondary biology curriculum through the mapping process**

No.	Concepts	Content identified in standard 9th	Content identified in standard 10th
1.	Heredity	✓	✓
2.	Living organism	✓	✓
3.	Taxonomy	✓	✓
4.	Pollution	X	✓
5.	Environment	✓	✓
6.	Human health	X	✓
7.	Life process	✓	✓
8.	Disaster management	X	✓
9.	Evolution	X	✓

Gaps in the secondary biology curriculum at secondary level are identified through the mapping process.

**CONCLUSION**

In brief, the study on "Curriculum Mapping for Quality Education" underscores the vital role of systematic mapping in advancing educational practices. Key findings emphasize the significance of aligning curriculum content with educational objectives, promoting collaboration, and addressing challenges. The suggested strategies are designed to improve curriculum mapping practices, ultimately contributing to the overarching aim of delivering quality education. Acknowledging the dynamic nature of education, the research aspires to be a catalyst for positive change and ongoing improvement in curriculum mapping, with the ultimate goal of enhancing educational outcomes.

**REFERENCES**

1. Al-Eyd, & et. al. (2018).Curriculum mapping as a tool to facilitate curriculum development: a new School of Medicine experience. BMC medical education, 18(1), 1-8. Retrieved from: <https://doi.org/10.1186/s12909-018-1289-9>.
2. Bone, E. K., & Ross, P. M. (2021).Rational curriculum processes: revising learning outcomes is essential yet insufficient for a twenty-first-century science curriculum. Studies in Higher Education, 46(2), 394-405. Retrieved from: <https://doi.org/10.1080/03075079.2019.1637845>
3. Harden, R. M. (2001).Curriculum mapping: a tool for transparent and authentic teaching and learning. AMEE. Retrieved from: <https://doi.org/10.1080/01421590120036547>.
4. Tanweer Alam, T. and Benaida, M., (2022), “Smart Curriculum Mapping and Its Role in Outcome-based Education”, Informatica (ISSN 0350-5596), Vol: 46, No: 4. Retrieved from: <https://doi.org/10.31449/inf.v46i4.3717>.
5. Uchiyama, K. P., & Radin, J. L. (2009).Curriculum mapping in higher education: A vehicle for collaboration. Innovative Higher Education, 33(4), 271-280. Retrieved from: <https://doi.org/10.1007/s10755-008-9078-8>.

# Sustainable Development Goals Reflected in Secondary School Textbook Content: A Qualitative Analysis Based on Bloom's Taxonomy

## Prachi Patil

M.Ed. Student  
Department of Education  
Shivaji University  
Kolhapur, Maharashtra  
✉ prachipatil2498@gmail.com

## Vidyanand Khandagale

Assistant Professor  
Department of Education  
Shivaji University  
Kolhapur, Maharashtra  
✉ vsk\_edu@unishivaji.ac.in

## ABSTRACT

Education, a potent catalyst for societal transformation, particularly in the formative years, plays a crucial role in shaping well-rounded individuals. Central to the educational landscape is the textbook, serving as the cornerstone of syllabi. This research examines how sustainable development goals are portrayed in Maharashtra State Board textbooks, with a focus on fostering action competence for these goals.

The overarching objective is to scrutinize the content across various subjects at the secondary level, Utilizing Bloom's Taxonomy as a lens, evaluate the extent to which the integration of Sustainable Development Goals (SDGs) in educational curricula fosters higher-order cognitive skills while also nurturing foundational knowledge and comprehension of sustainability principles. The examination demonstrates a prevailing focus on Sustainable Development Goals (SDGs) related to environmental sustainability and infrastructure development at the foundational levels of Bloom's Taxonomy.

However, this analysis highlights a crucial gap in the exploration of SDGs pertaining to social equity and inclusive development, such as No poverty, Zero hunger, Partnership for the goals, Gender equality, and Reduced inequalities, at the higher cognitive levels of Bloom's Taxonomy. This study advocates for a recalibration of educational content to promote deeper engagement and critical analysis of these imperative SDGs, ensuring a more holistic approach to sustainable development education.

**KEYWORDS** : *Secondary school textbooks, Sustainable development goals, Qualitative study, Bloom's taxonomy.*

Abbreviations: M-Marathi, H-Hindi, S-science, Hs-History, G-Geography, Ag.-aggregate. %-Percentage Mt-Math's, E-English.

## INTRODUCTION

The Millennium Development Goals originate from the declaration, a historic accord endorsed by 189 nations, with participation from 147 heads of state and government in September 2000. Comprising eight objectives, these goals endeavor to tackle pressing global issues by 2015 and encompass targets.

In 2015, the United Nations introduced the Sustainable Development Goals (SDGs), also known as Global Goals, as a successor to the MDGs. The SDGs represent

a universal call to action, aiming to eliminate poverty, protect the planet, and ensure prosperity and peace for all by 2030. This comprehensive agenda comprises 17 goals unanimously adopted by all UN member states.

Recognizing that sustainable development is imperative not only for present human survival but also for safeguarding future generations, education emerges as a potent force. Education helps in the national progress and also plays a pivotal role in advancing sustainable development objectives, aligning with the

broader mission to create a more equitable, resilient, and prosperous world. Textbook serves as a backbone of any education system. If the textbooks are well organized then there will be inculcation of SDGs.

Teaching and learning require some aid to make the process easier. One of these aids is textbook. Textbooks serve as a guide to the curriculum and syllabus which is framed by the education policy makers.

Textbooks are the main source of contact to students. It is a device for students to make the teaching learning process easy. Teachers also get a compile content of syllabus to teach students. Various activities are implemented by teachers with the help of textbooks for making teaching learning process more effective. So to make students aware of SDGs it is necessary to implement SDGs goals in textbooks of the secondary level. The content analysis holds significance for authors, curriculum planners, and curriculum decision-makers in curriculum development helping in the creation of high quality and standard textbooks. It also helps to develop good and standard textbooks to enhance student attitudes and behavior in their lives. By analyzing and categorizing the content according to the levels of blooms taxonomy we can gain the overall insights of cognitive and instructional objectives of the material.

### Statement of the problem

Content analysis of secondary level textbooks of Maharashtra state board to study the implementation of sustainable development goals based on Bloom's taxonomy.

### Objectives

- 1 The identification of sustainable development goals reflected in secondary level school textbook.
- 2 To analyze SDG's reflected in secondary level school textbooks based on bloom's taxonomy.
- 3 To make suggestions based on the findings of the study.

### Delimitations

The study is delimited to the 6th,7th,8th,9th, and 10th grades of all subjects of the Maharashtra state board.

## LITERATURE REVIEW

Martínez-Medina ,(2019): et al Studied ,The education is the important tool to educate the society about sustainable development goal . In this research analysis of the textbooks of social sciences in primary education is done and the results reveals that cognitively simple activities are more included in elementary education textbooks whereas the complex activities are less.

Bayaydah, A. M.(2020): et al has studied to identify the outline of final exam questions prepared by English teachers for 9th and 10th grades based on Bloom's taxonomy. The study reveals that there is no statistical difference between the frequencies and percentage of questions of final exams which are analyzed and the textbooks for grades 9th and 10th..

E. Eliyawati , (2022): et al performed the research to analyze the students textbook from the point of view of sustainable development goal. This research is related to the study of six textbooks for elementary school, three for junior high school, and three for senior high school. The study revealed that at the high school level, students study the context of sustainability and not in the elementary level.

R.Alexande's (2012). Research aims to foster the transfer of necessary knowledge ,skills and attitudes to protect the environment and sustainable development goals in selected high schools of puducherry region

.The study was related to the assessment of students' knowledge, behavior attitudes, and actions toward environmental problems. It reveals that the environmental education is necessary for students but it is given very little importance.

de la Fuente, (2022) observed in his study ,It was very important to understand sustainable development goals as it helps us to live sustainably. The study analyzed the impact of multi-disciplinary instructional modules that incorporated sustainable development education based on migration, cultural identity, etc

Ismail, (2015) in his content study found that teachers gain knowledge that promote an ESD point of view on each subject which considers Socio-cultural, environmental, and economic factors.The teaching resources were examined which revealed that it is

necessary to revise the teaching resources from the ESD point to make students aware of the growing environmental issues.

## METHODOLOGY

In the current study Textbook analysis of the secondary level was done to analyze the reflection of SDGs.

The scoring system has been developed to quantify the Alignment of the textbook with each evaluation Criterion. The scale from 1 to 5 has been used, where 1 indicates minimal alignment with Bloom's taxonomy and 5 indicates strong alignment with taxonomy of Blooms.

Bloom's taxonomy levels-

Knowledge-1, Comprehension-2, Apply-3, Analyze-4, Evaluate-5

Critical thinking or evaluation is the higher-order thinking skill whereas remembering is the lower-order thinking skill.

**Table 1: Reflection of SDG's in STD 6 textbooks**

Goals	M	H	S	Hs	G	Ag	%
Clean water and sanitation	1	1	5	3		10	40
Affordable and clean energy	1		1		1	3	12
Economic growth					1	1	4
Industry					1	1	4
Sustainable cities	5					5	20
Production	1	4	1		4	10	40
Life below water		4			1	5	20

### Analysis and interpretation of Std. 6 textbooks

Results illustrate that the goals such as Sustainable cities, clean water for all, conservation of marine life, and disaster management were reflected at higher order in Marathi, Hindi, and science. The environmental related factors such as renewable and nonrenewable energy are reflected more as compared to the economic and social topics such as peace, equity, and social responsibility. In history, it reflects only the use of clean drinking water at the application level whereas affordable use of clean energy conservation of energy, protection of culture and natural heritage, reduction of marine pollution were reflected at lower level in Marathi, science and geography.

**Table 2: Reflection of SDG's in STD 7 textbooks**

Goals	E	M	H	S	Hs	G	Ag	%
No Poverty					5		5	17
Zero hunger	2	2	1	1	1	4	11	36.77
Quality education	2	2	1		5		10	33.33
Clean water use				1	1	1	3	10
Affordable and clean energy				1		2	3	10
Industry, innovation, infrastructure					1	1	2	6
Sustainable cities	5		1		1		7	23.33
Responsible consumption and production				1	5		6	20
Life on land	3	1		1	5	5	15	50

### Analysis and interpretation of Std 7 textbook

Results illustrate that Goals such as the upgradation of slums, quality education, recycling and reuse, deforestation, and biodiversity were reflected at higher order in subjects such as English, history, and geography whereas goals such as agriculture productivity, employment, gender equality, pollution, water resource management, protection of marine life, and deforestation were reflected at lower thinking levels in all subjects.

**Table 3: Reflection of SDG's in STD 8 textbooks**

Goals	E	M	H	Mt	S	Hs	G	Ag	%
Zero hunger		5		5			2	12	34
Good health and well being	1				1	2		4	11
Quality education	5	5				1		11	31
Gender equality		3				2		5	14
Affordable and clean energy					3			3	9
Reduced inequalities							2	2	6
Sustainable cities and communities		5						5	14
Climate action				5	5			10	29
Life below water	5				5			10	29
Life on land		5		5	4			14	40
Peace, justice, strong institution			4					4	11

### Analysis and interpretation of Std - 8 textbooks

Food for all, quality education, sustainable cities, life below water, and justice were reflected at higher thinking order in all subjects except history whereas the importance of good health, mental well-being, protection



of the environment, conservation of ecosystem was reflected at lower thinking level in English, science, and geography.

**Table 4: Reflection of SDG's in STD 9 textbooks**

Goals	E	M	H	Mt	S	Hs	G	Ag	%
Zero hunger				5			5	10	29
Good health	5	3					5	13	37
Quality education	1	4	5			4	4	18	51
Clean water and sanitation			1		5	1		7	20
Sustainable cities and communities	4	4	5				5	18	51
Responsible consumption and production							5	5	14
Climate action		5						5	14
Life below water							5	5	14
Life on land	3					5		8	23

#### Analysis and interpretation of Std-9 textbooks

Results illustrates that agriculture productivity, good health, quality education for girls and boys, consumption of safe water, sustainable cities and management, climate changes, marine pollution, desertification, and restoration of land and soil are reflected at higher order in all subjects whereas small scale industries, partnership with other countries for achieving goals are reflected at lower thinking order.

**Table 5: Reflection of SDG's in STD 10 textbooks**

Goals	E	M	H	Mt	S	Hs	G	Ag	%
Poverty	1							1	3
Zero hunger		5		5		1	5	16	46
Good health and well being	5	5			1	5		16	46
Gender equality						4	1	5	14
Clean water and sanitation			5		5		5	15	43
Affordable and clean energy			4		1			5	14
Decent work and economic growth				3				3	9
Industry,				4			1	5	14
Reduced inequalities	3							3	9
Sustainable cities					4			4	11
Responsible consumption and production					5			5	14
Climate action					1			1	3

Life below water	5				5			10	29
Life on land	5	3	4	4	1		5	22	63

#### Analysis and interpretation of Std 10 textbooks

Results illustrates that goals such as quality education, afforestation, and conservation of the ecosystem are reflected at a higher thinking level whereas the end of poverty, zero hunger, mental health, and protection from diseases are reflected at a lower level of thinking.

#### FINDINGS AND DISCUSSION

- In SDG 1, equal rights to men and women is reflected 17% in class VII textbooks while in class X, eradicate extreme poverty is for 3 %.
- In SDG 3 , in class VII, end hunger is 3%, increasing agriculture productivity is 23% and free and quality education is 30%,double agriculture productivity in class IX .
- In SDG 4,,eliminating gender disparities in education and include children with disabilities is only included in class X for 29%.
- In SDG 5, include women participation is 10 % in class VII,9% in class VIII ,whereas recognizing and valuing unpaid care and domestic work through provision of public services, infrastructure and social protection is not included in class X.
- In SDG 6, importance of safe drinking water reflects 36% ,reducing the release of harmful chemicles reflect about 8% in std VI textbooks.
- In SDG 7, preserving renewable energy is reflected 12 % and universal access to affordable energy is 8% in class VI textbook. Water resource management is 3% in class VII textbook. Upgrade infrastructure and expand technology is 3% in std VIII textbook. And in std X universal use of affordable energy is 14%, use of renewable energy is 14% and upgrade technology is 3%.
- In SDG 8, Economic productivity through diversification is reflected at very low percent in secondary textbooks from 3% to 9%.
- In SDG 9, use of clean and environmental sound technologies is reflected 4% in class VI and 11% in class X, increasing the use of small scale

industries is 7% in class VII and 3% in class X, raise employment in industries is 14% in class VIII.

- In SDG 10, empower and promote social, economic and political inclusion is 6% in class VIII, and 9% in class X.
- In SDG 11, protect world's culture and natural heritage is reflected 4% in class VI textbook, 7% in class VII and 14% in std IX. Access to affordable housing and upgrade slums in 17% in std VII textbook, 14% in std VIII, and 11% in std IX.
- In SDG 12, reduce air, water and soil pollution is reflected 20% in std VI textbooks, 3% in class VII, 3% in class VIII and 14% in class X. Achieve sustainable management and efficient use of natural resources is 14% in class IX.
- In SDG 13, Improve educational awareness on climate change is reflected 14% in class VIII textbooks and 3% in class X.
- In SDG 14, reduce marine pollution is 4% in class VI textbooks, 14% in class VIII, 14% in class IX and 29% in class X textbooks. Protect marine and coastal ecosystem is 16% in class VI, 3% in class VII, 14% in class VIII textbooks. Reduce destructive fishing practices is 3% in class X textbooks.
- In SDG 15, restore degraded land and soil is 16% in class VI and 17% in class X. Conserve inland fresh water ecosystem is 8% in Class VI, 3% in class VII, 26% in class VIII, 9% in class IX and 11% in Class X. Restoring degraded forest is 49% in std X, protect biodiversity is reflected 3% in class VIII.
- In SDG 16, peace and justice is reflected 11% in std VIII, 3% in std IX textbooks.
- In SDG 17, strengthen domestic resource mobilization and international support to additional countries. Is 3% in class IX and 3% in class X.

## CONCLUSION

On the basis of analysis done in the research it can be interpreted that issues related to the environment are most frequently discussed. Textbooks also provide some real-world examples on the application level. But issues such as employment, ending poverty, and the goals for sustainable development of mankind need to be discussed more in the textbooks. Math textbooks

need to be redefined as it reflects very little on sustainable development goals. The lower-order thinking skills related to knowledge and comprehension have been focused more on 6th and 7th standards whereas higher-order thinking skills have achieved less attention. Also, the issues related to poverty are not included in the textbooks. Due to this students will be unaware of the country's fact of poverty.

## SUGGESTION

It is essential to compile a book that encompasses maximum sustainable development goal. The textbooks should provide real-world examples and case studies related to SDGs. The textbooks should emphasize conditions of poverty and unemployment in the country. Also, the textbooks should include fundamental

concepts related to SDGs. So it is necessary to redesign the textbooks of the secondary level as the textbooks serve as a valuable tool for building a sustainable future for students.

## REFERENCES

1. Alexander, R. (2012). Environmental education for sustainable development in selected schools of Puducherry and Cuddalore regions, India. Unpublished Thesis). Pondicherry University. Tamilnadu.
2. Bayaydah, A. M., & Altwieissi, A. I. (2020). A BLOOM'S TAXONOMY-BASED ANALYSIS OF 9th And 10th GRADES ENGLISH LANGUAGE TEXTBOOKS' FINAL EXAMINATIONS AND REVISION QUESTIONS. International Online Journal of Primary Education, 9(2), 197-211.
3. de la Fuente, M. J. Education for Sustainable Development in Foreign Language Learning.
4. Eliyawati, E., Widodo, A., Kaniawati, I., & Fujii, H. (2022). Education for Sustainable Development (ESD) in Students' Textbooks. Journal of Engineering Science and Technology Special Issue on ICMSce2022. <https://www.ipcc.ch/report/ar4/wg1>.
5. Ismail, I., Rochintaniawati, D., Permanasari, A., & Riandi, R. (2022). Content Study Of 7th-Grade Science Textbooks Using An ESD Viewpoint On Living Things And Their Surroundings. Ta'dib, 25(1), 117-128.
6. Martínez-Medina, R., & Arrebola, J. C. (2019). Analysis of sustainability activities in Spanish elementary education textbooks. Sustainability, 11(19), 5182.

# Global Challenges, Local Solutions: SDGs in Diverse Educational Contexts

**Nigar K. Mujawar**

Department of Pharmaceutics  
Womens College of Pharmacy  
Peth Vadgaon  
Kolhapur, Maharashtra  
✉ nigarwcop2017@gmail.com

**Rekha L. Nirmale**

Incharge Principal  
College of Education  
Peth Vadgaon  
Kolhapur, Maharashtra  
✉ rekhanirmale2107@gmail.com

**Vidyanand S. Khandagale**

Department of Education  
Shivaji University  
Kolhapur, Maharashtra

## ABSTRACT

The Sustainable Development Goals, also known as the SDGs, are an around-the-world project launched in 2015 to address a variety of problems including inequality, climate change, poverty, and environmental degradation. They attempt to establish an extensive structure for sustainable development by incorporating 17 interconnected goals from financial, social, & environmental perspectives. Guided by principles such as universality and "Leave No One Behind," they stress inclusivity and global cooperation. Integration underscores their interconnectedness, while accountability mechanisms track progress. Education is vital, serving as both a goal and an enabler for sustainable development by empowering individuals with knowledge and skills. Challenges like resource shortages and governance issues persist, hindering implementation, and necessitating global collaboration for solutions. Integrating SDGs into education is crucial for achieving them and fostering a Creating a more diverse, just, and sustainable future.

**KEYWORDS** : *Sustainable development goals, Global commitment, Universality, Education for sustainable development, Accountability mechanisms.*

## INTRODUCTION

The United Nations adopted the Sustainable Development Goals (SDGs) to solve the world's greatest concerns and encourage sustainable development. The SDGs, which are based upon the Millennium Development Goals (MDGs), establish a comprehensive and universal framework for sustainable development. SDGs strive to achieve a balance between economic growth, social inclusivity, and environmental sustainability, aiming for a brighter future for all. These 17 interconnected goals (Figure 1) were established through a collaborative effort that included governments, civic society, academia, and other stakeholders. Each goal is followed by 169 precise targets, which serve as a road map for action at the global, national, and neighborhood levels. In September 2015, the United Nations General Assembly approved the SDGs as part of the 2030 Agenda, or list for Goals of Sustainable Development, signaling a

watershed point in global efforts to address fundamental issues plaguing humanity and the planet.

The 2030 Agenda highlights world leaders' shared commitment to achieving sustainable development and creating a safer and more equitable world for current and future generations.

These goals cover a wide range of global issues, including poverty, hunger, wellness, education, equality of genders water and hygiene quality, clean and affordable energy, economic growth, climate change, ecological sustainability, peace, and justice.

## NEED FOR SDGS

In our increasingly interconnected world, tackling global challenges demands a multifaceted strategy that begins with education. Embedding the SDGs in various educational environments is crucial due to how it equips students with the information, skills,

and attitudes required to deal with complex global issues. By customizing educational methods to fit regional and cultural contexts, schools and universities can ensure that learning experiences resonate with students' backgrounds and realities, thereby fostering deeper engagement and comprehension. Highlighting successful examples of SDG integration not only illustrates the practicality of implementing these goals but also motivates educational institutions worldwide to innovate and collaborate toward sustainable development. This approach not only empowers students to become proactive changemakers within their communities but also establishes the groundwork for constructing A healthier, more competitive, and secure future for everyone.

sense of ownership and empowerment among students. It lays the foundation for sustainable development endeavors that are not only impactful but also inclusive, ensuring that everyone has a stake in shaping a more sustainable future.

## STRUCTURE OF THE SDGS

### Divisions

Economic development goals are focused on poverty eradication, encouraging sustainable and inclusive economic growth, assuring decent jobs and livelihoods, and fostering innovation and infrastructure development.

- a) **Social Dimension:** Goals in the social dimension seek to achieve social equity, justice, and well-being for all. They include aspirations for health, education, gender equality, social protection, and inclusive society.
- b) **Environmental Dimension:** Goals related to the environment seek to safeguard and maintain the planet's natural resources and ecosystems. They include goals for climate action, biodiversity conservation, sustainable natural resource management, clean energy promotion, and sustainable consumption and production practices.

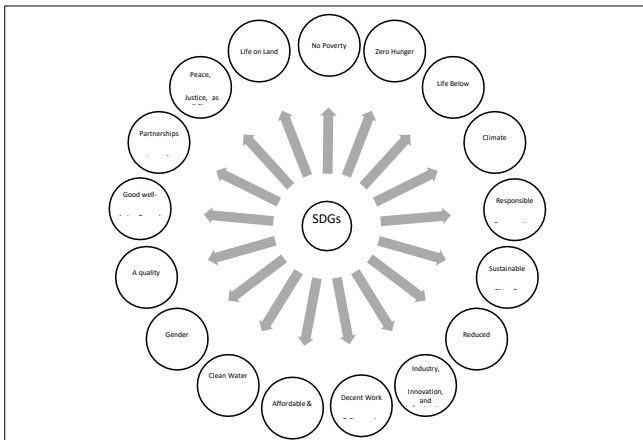

**Figure 1. Sustainable Development Goals encompass 17 distinct goals**

## FACTS OF SDGS

A significant aspect to note is that implementing the SDGs within diverse educational environments isn't just about addressing global challenges; it's also about tapping into local solutions. By customizing educational methods to fit regional and cultural intricacies, schools and universities can effectively involve students and communities in meaningful dialogues and actions concerning sustainability. Successful examples of SDG integration in educational institutions worldwide underscore the adaptability and efficacy of these goals in different settings, showcasing innovative approaches and sparking further collaboration and learning. This focus on tailoring education to local contexts not only boosts relevance and engagement but also nurtures a

### Goals and Targets

Provide a summary of the 17 goals and their respective targets, emphasizing the comprehensive nature of the agenda discussed in Table 1. below.

**Table 1. Sustainable Development Goals 17 goals and their respective targets**

Goal	Title	Targets
1	No Poverty	Eradicate extreme poverty. Reduce poverty by at least half.
2	Zero Hunger	End hunger as well as ensure access to food for all. End malnutrition as well as ensure access to nutritious food.
3	Good Health & Well-being	Reduce maternal and child mortality. End epidemics such as AIDS, tuberculosis, malaria, and other communicable diseases.

4	Quality Education	Make sure everyone has access to high-quality, inclusive education. Get rid of the gender gap in their education.
5	Gender Equality	Put an end to harassment and prejudice against women & girls. Guarantee women's complete involvement in decision-making procedures.
6	Clean Water & Sanitation	Make sure everyone has access to clean, safe drinking water. Ensure that everyone has access to sufficient hygiene and sanitation.
7	Affordable & Clean Energy	Ensuring that everyone gets a chance to use cost-effective, dependable, and innovative energy resources. Encourage the global energy mix to include more energy from renewable sources.
8	Decent Work & Economic Growth	Encourage long-term, inclusive, & sustainable economic growth. Ensure full, productive employment along with excellent jobs for everybody.
9	Industry, Innovation, & Infrastructure	Create high-quality, dependable, sustainable, & resilient infrastructure. Encourage inclusive & sustainable the industrialization process.
10	Reduced Inequality	Lessen the disparity in income between and within nations. Encourage and empower everyone to participate in society, the economy, and politics.
11	Sustainable Cities & Communities	Create towns and human settlements that are welcoming, secure, resilient, and sustainable. Ensure that everyone has access to safe, cheap, accessible as well sustainable transportation.

12	Responsible Consumption & Production	Adapt to environmentally friendly consumption as well as manufacturing methods. Ensure sustainable strong management as well as effective use of natural resources.
13	Climate Action	Increase your bravery and ability to adapt to climate- related emergencies. Incorporate strategies, plans, and policies at the national level that address climate change.
14	Life Below Water	Conserve and responsibly use the oceans, the seas, as well as marine resources. Promote sustainable fisheries while also protecting and restoring habitats.
15	Life on Land	Preserve, repair, and encourage ecosystems on earth to be used wisely. Stop deforestation as well as repair degraded forests.
16	Peace, Justice & Strong Institutions	Reduce violence & ensure equal access to justice. Put an end to all forms of assault that target children, including abuse, exploitation, and trafficking.
17	Partnerships for the Goals	Increase local resource mobilization and global collaboration for sustainable development.

This table summarises each of the 17 Sustainable Development Goals (SDGs) as well as their related goals, demonstrating the scope of the agenda.

### KEY PRINCIPLES UNDERLYING THE SDGS

#### Universality

The SDGs are globally relevant and emphasize countries' interconnectedness as well as their shared responsibility to tackle issues such as inequality, poverty, climate change, in addition to environmental degradation. This recognition of universality obliges



all countries to collaborate and take action within their means to achieve common objectives.

**Leave No One Behind**

The "Leave No One Behind" principle of the SDGs underscores the imperative of inclusivity, ensuring that progress towards these goals extends to marginalized and vulnerable groups. This principle recognizes that certain segments of society, such as women, children, people with disabilities, indigenous peoples, refugees, and migrants, often face heightened levels of poverty, discrimination, and social exclusion. To effectively address these disparities, governments and stakeholders must prioritize the needs of these groups, crafting policies and initiatives that are inclusive, equitable, and responsive to their unique circumstances. Ultimately, this principle highlights the fundamental idea that sustainable development can only be achieved when the needs and rights of all individuals are upheld and respected.

**Integration**

The Integration principle of the SDGs underscores the interconnected nature of these goals and the necessity of integrated strategies for sustainable development. It recognizes the inherent linkages between social, economic, and environmental aspects of development, emphasizing their mutual reinforcement. Integrated approaches involve addressing multiple goals simultaneously, identifying synergies, and mitigating trade-offs to optimize outcomes. Policymakers are urged to adopt holistic policies that promote cross-sectoral coherence and leverage interlinkages between different objectives to drive progress effectively.

**Accountability**

The Accountability principle of the SDGs underscores the significance of robust monitoring, review mechanisms, and transparent methods for tracking progress. It advocates for data-driven decision-making and effective governance frameworks to facilitate successful implementation and follow-up. Examples of accountability mechanisms include regular reporting, peer reviews, national assessments, and stakeholder engagement, which help assess progress, identify challenges, and mobilize action. This principle holds governments, institutions, and stakeholders accountable

for their commitments and promotes continuous learning, adaptation, and improvement in pursuit of the SDGs. These fundamental concepts form the basis for SDG implementation, emphasizing the necessity of global cooperation, inclusivity, integration, and accountability in advancing sustainable development goals.

**Significance of education for achieving the SDGs, the role of education**

This table provides a systematic overview of the importance of education in attaining the SDGs, its function, and specific education targets under Goal 4 and other related goals. Discussed in Table 2. below:

**Table 2. Significance of education for achieving the SDGs, the role of education**

Sr. No.	Significance for Education	Role of Education	Education Targets
1	Role of Education	Education plays a critical role in achieving the SDGs by empowering individuals, building human capital, and fostering skills and knowledge for addressing global challenges.	Goal 4 of the SDGs focuses on Quality Education with the following targets:  Make sure every student receives a high-quality, inclusive education.  Eliminate gender disparities in education.  Ensure that everyone has equal access to excellent, reasonably priced technical and vocational education.  Boost the proportion of young people and adults with the necessary skills for job opportunities, respectable employment, and entrepreneurship.  Make sure every student learns the required information and abilities.  These targets aim to promote accessible, equitable, and high-quality education for all, addressing disparities and ensuring individuals are equipped with the skills

2	Education Targets	Specific targets under Goal 4 and other goals emphasize the importance of education for various aspects of sustainable development.	<p>Other goals related to education include:</p> <p>Objective 5: The equality of Gender: Target 5.5 is to guarantee women's equal leadership opportunities and full and efficient involvement in all spheres of economy, politics, and societal decision-making.</p> <p>Objective 6: Sanitation along with Clean Water: The goal of Target 6.1 is to provide everyone with equal access to secure and reasonably priced drinking water.</p> <p>Objective 12: Conscientious Production along with Consumption: Assuring that everyone has the opportunity to obtain the information and understanding required for sustainable development and environmentally friendly lifestyles is the main goal of Target 12.8.</p> <p>With a focus on the connections between achievement and gender equality, access to sanitation and clean water, and the promotion of sustainable patterns of consumption and production, these objectives underscore the larger context within which education functions.</p>
---	-------------------	---	--

**Gaps**

Despite improvements, substantial gaps remain in meeting the SDGs. Disparities exist within and between countries, with marginalized and vulnerable populations frequently falling behind. Inequality, both in terms of income and access to opportunities, remains a significant issue. Climate change is a major challenge to sustainable development, aggravating poverty, food insecurity, and environmental degradation. Furthermore, conflicts, humanitarian crises, and the COVID-19 pandemic have slowed progress towards the SDGs, especially in fragile and conflict-affected areas.

**Challenges**

**Inadequate Resources:** Many countries struggle to raise enough funds to effectively execute the SDGs. Limited finance, competing goals, and fiscal constraints impede progress, especially in low-income and developing countries.

Addressing resource shortfalls necessitates additional investment, novel finance arrangements, and strengthened international collaboration.

a) **Insufficient Data:** Data availability, quality, and disaggregation continue to be important hurdles in measuring progress towards the SDGs. Many nations lack dependable data systems and statistical capabilities, making it difficult to accurately monitor and evaluate SDG targets. Improving data collecting, analysis, and reporting procedures is critical for evidence-based policy and decision-making.

b) **Conflicts and Fragility:** Conflicts, violence, and instability stymie progress towards the SDGs, impeding efforts for peace, security, and sustainable development. Fragile and conflict-affected nations confront unique obstacles in implementing the SDGs, as instability impedes development measures, impairs governance systems, and exacerbates humanitarian needs. Combating conflict and fragility necessitates coordinated efforts to promote peacebuilding, conflict resolution, and inclusive development.

**GLOBAL PROGRESS TOWARDS THE SDGS SINCE THEIR ADOPTION, ALONG WITH KEY CHALLENGES**

**Progress Report**

**Achievements:** Since the SDGs were adopted in 2015, significant progress has been made in a variety of sectors. There has been progress in eliminating extreme poverty, boosting access to education and healthcare, supporting gender equality, extending renewable energy access, and developing global collaborations for sustainable development. Many countries have made

- c) Governance Issues: Poor governance, corruption, and institutional capacity restrictions impede SDG implementation and erode trust in public institutions. Strengthening governance institutions, encouraging openness and accountability, and increasing civic involvement are key to enabling inclusive and participatory decision-making processes and ensuring effective SDG implementation.

### IMPORTANCE FOR FUTURE ASPECTS:

The value of adopting the SDGs within various educational contexts arises from their potential to address specific challenges, seize opportunities, as well as promote global sustainability. By tailoring educational approaches to regional and cultural nuances, schools and universities can effectively engage students in understanding and tackling pressing global issues within their local contexts. Showcasing successful case studies of SDG integration not only highlights best practices but also inspires innovation and collaboration among educational institutions worldwide. This approach not only equips students with the knowledge, skills, and values needed to become active global citizens but also empowers them to contribute meaningfully to achieving the SDGs in their communities and beyond.

### CONCLUSION

The SDGs provide a comprehensive framework for addressing significant global concerns like inequalities, poverty, worldwide warming, and environmental degradation. Adopted by the United Nations General Assembly in 2015, they signify a landmark moment in global cooperation for sustainable development. Universally applicable, the SDGs prioritize inclusivity, integration, and accountability, emphasizing the role of education as both a standalone goal and a key enabler. By integrating the SDGs into diverse educational contexts, we can equip individuals with the knowledge, skills, and values necessary to drive progress toward a more equitable, resilient, and sustainable future for all. This collective approach underscores the importance of collaboration across society at all levels.

### REFERENCES

- Hák, T., Janoušková, S., & Moldan, B. (2016). Sustainable Development Goals: A need for relevant indicators. *Ecological indicators*, 60, 565-573.
- Elliott, J. (2012). *An introduction to sustainable development*. Routledge.
- Katila, P., Colfer, C. J. P., De Jong, W., Galloway, G., Pacheco, P., & Winkel, G. (Eds.). (2019). *Sustainable development goals*. Cambridge University Press.
- Abashidze, A. K., Solntsev, A. M., Kiseleva, E. V., Evgenâ, A., & Kruglov, D. A. (2016). Achievement of Sustainable Development Goals (2016-2030): international legal dimension. *Indian Journal of Science and Technology*.
- Halonen, M., Persson, Å., Sepponen, S., Siebert, C. K., Bröckl, M., Vaahtera, A.,... & Isokangas, A. (2017). *Sustainable development action—the Nordic Way: Implementation of the global 2030 agenda for sustainable development in Nordic cooperation*. Nordic Council of Ministers.
- Colglazier, W. (2015). Sustainable development agenda: 2030. *Science*, 349(6252), 1048-1050.
- Chasek, P. S., Wagner, L. M., Leone, F., Lebada, A. M., & Risse, N. (2016). Getting to 2030: Negotiating the post-2015 sustainable development agenda. *Review of European, Comparative & International Environmental Law*, 25(1), 5-14.
- Fu, B., Wang, S., Zhang, J., Hou, Z., & Li, J. (2019). Unravelling the complexity in achieving the 17 sustainable-development goals. *National Science Review*, 6(3), 386-388.
- Olga, M., Natalia, T., & Janos, Z. (2015). Sustainable development goals: why do we need them?. *Social Evolution & History*, 14(2), 176-190.
- Sachs, J. D. (2015). Achieving the sustainable development goals. *Journal of International Business Ethics*, 8(2), 53-62.
- Fayomi, O. S. I., Okokpujie, I. P., & Udo, M. (2018, September). The role of research in attaining sustainable development goals. In *IOP Conference Series: Materials Science and Engineering* (Vol. 413, No. 1, p. 012002). IOP Publishing.
- Salvia, A. L., Leal Filho, W., Brandli, L. L., & Griebeler, J. S. (2019). Assessing research trends related to Sustainable Development Goals: Local and global issues. *Journal of cleaner production*, 208, 841-849.
- Kioupi, V., & Voulvoulis, N. (2019). Education for sustainable development: A systemic framework for connecting the SDGs to educational outcomes. *Sustainability*, 11(21), 6104.

14. Shulla, K., Filho, W. L., Lardjane, S., Sommer, J. H., & Borgemeister, C. (2020). Sustainable development education in the context of the 2030 Agenda for sustainable development. *International Journal of Sustainable Development & World Ecology*, 27(5), 458-468.
15. Glavič, P. (2020). Identifying key issues of education for sustainable development. *Sustainability*, 12(16), 6500.
16. Žalėnienė, I., & Pereira, P. (2021). Higher education for sustainability: A global perspective. *Geography and Sustainability*, 2(2), 99-106.
17. Reddy, P. S. (2016). Localising the sustainable development goals (SDGs): the role of local government in context.
18. Giangrande, N., White, R. M., East, M., Jackson, R., Clarke, T., Saloff Coste, M., & Penha-Lopes, G. (2019). A competency framework to assess and activate education for sustainable development: Addressing the UN sustainable development goals 4.7 challenge. *Sustainability*, 11(10), 2832.
19. Osborn, D., Cutter, A., & Ullah, F. (2015). Universal sustainable development goals. Understanding the transformational challenge for developed countries, 2(1), 1-25.
20. Fukuda-Parr, S., & Smaavik Hegstad, T. (2018). "Leaving no one behind" as a site of contestation and reinterpretation. *Journal of Globalization and Development*, 9(2), 20180037.
21. Heleta, S., & Bagus, T. (2021). Sustainable development goals and higher education: leaving many behind. *Higher Education*, 81(1), 163-177.
22. Amoros Molina, A., Helldén, D., Alfvén, T., Niemi, M., Leander, K., Nordenstedt, H., & Biermann, O. (2023). Integrating the United Nations sustainable development goals into higher education globally: a scoping review. *Global Health Action*, 16(1), 2190649.
23. Yanniris, C. (2021). Education for sustainability, peace, and global citizenship: An integrative approach. *Education Sciences*, 11(8), 430.
24. Abhayawansa, S., Adams, C. A., & Neesham, C. (2021). Accountability and governance in pursuit of Sustainable Development Goals: conceptualising how governments create value. *Accounting, Auditing & Accountability Journal*, 34(4), 923-945.
25. Leal Filho, W., Tripathi, S. K., Andrade Guerra, J. B. S. O. D., Giné-Garriga, R., Orlovic Lovren, V., & Willats, J. (2019). Using the sustainable development goals towards a better understanding of sustainability challenges. *International Journal of Sustainable Development & World Ecology*, 26(2), 179-190.
26. Nazar, R., Chaudhry, I. S., Ali, S., & Faheem, M. (2018). Role of quality education for sustainable development goals (SDGs). *International Journal of Social Sciences*, 4(2), 486-501.
27. Chaleta, E., Saraiva, M., Leal, F., Fialho, I., & Borralho, A. (2021). Higher education and sustainable development goals (SDG)—potential contribution of the undergraduate courses of the school of social sciences of the University of Évora. *Sustainability*, 13(4), 1828.
28. Ashida, A. (2022). The role of higher education in achieving the sustainable development goals. In *Sustainable development disciplines for humanity: Breaking down the 5Ps—people, planet, prosperity, peace, and partnerships* (pp. 71-84). Singapore: Springer Nature Singapore.
29. TRENDS, G. (2017). Challenges and opportunities in the implementation of the Sustainable Development Goals. United Nations Development Programme & United Nations Research Institute for Social Development.
30. Dalby, S., Horton, S., & Mahon, R. (2019). Global governance challenges in achieving the Sustainable Development Goals: Introduction. In *Achieving the sustainable development goals* (pp. 1-18). Routledge.
31. Allen, C., Smith, M., Rabiee, M., & Dahmm, H. (2021). A review of scientific advancements in datasets derived from big data for monitoring the Sustainable Development Goals. *Sustainability Science*, 16(5), 1701-1716.
32. Huan, Y., Liang, T., Li, H., & Zhang, C. (2021). A systematic method for assessing progress of achieving sustainable development goals: A case study of 15 countries. *Science of the Total Environment*, 752, 141875.
33. Samman, E., Lucci, P., Hagen-Zanker, J., Bhatkal, T., Simunovic, A. T., Nicolai, S.,... & Caron, C. (2018). SDG progress: Fragility, crisis and leaving no one behind. ODI Report.
34. Nweke, A. C. (2021). Transition From Fragility to Sustainable Development: Case Study of Darfur in Sudan (Doctoral dissertation, Walden University).
35. Niklasson, L. (2019). Improving the sustainable development goals: Strategies and the governance challenge. Routledge.

# Bridging the Academic Divide, Integrating Literacy and Numeracy Applications for Primary Students to Propel the Fifth Industrial Revolution

**Geeta Sugandh Ghatage**

Research Scholar  
Department of Education  
Shivaji University  
Kolhapur, Maharashtra

**Rupali Uttam Sankpal**

Assistant Professor  
Department of Education  
Shivaji University  
Kolhapur, Maharashtra

## INTRODUCTION

After the fifth industrial revolution (5IR), rapid changes took place in many different sectors. This is mainly due to advances in technology. The education sector has also not remained untouched by this technological advancement. For the overall development of the students, it is necessary to have a holistic approach. Only then will we be able to produce skilled citizens who will face the world of economic changes in the 21st century. Drawing on earlier research on foundational linguistic and mathematical literacy, this paper will help teacher education thinkers working in the field of education to devise some strategies on how to build a future generation that matches or adapts school education and the fifth industrial revolution.

For digital literacy, it is necessary to provide maximum services by starting internet connection in public and private form. Technological services will be developed and provided to consumers through various apps and websites. A teacher who teaches in the digital age should also be a techno-savvy. He/She should have knowledge of various updates in the field of technology. Hence training should be organized for teachers to improve their technology based knowledge and teaching skills. Such type of training should be made available online and offline for them. However along with teachers now days it is essential that in the learning process the stakeholders such as parents and community should involve for imparting learning resources to the learners. Therefore the learners can get more learning opportunities through it. Those learning resources are

different media's such as virtual aids, dialogues and interaction with cultural and social communities. Hence in the era of fifth industrial revolution, basic language learning skills and mathematical literacy at the primary level have become more important. As we required well skilled futuristic global citizens in upcoming years and foundation is based on these skills, which are required to become good citizens of the global as well as they can able to contribute development of the tomorrow's world. Thus, this research paper devoted to discuss bridging the academic divide, integrating literacy and numeracy applications for primary students to propel the fifth industrial revolution. However this study is undertaken with three objectives, those are as follows:

1. To identify the literacy and numeracy skills required by primary students(standatd 1st to 7th )essential for aligning with 5IR.
2. To study existing primary education level (standard 1st to 7th )skills that aligns with 5IR requirements.
3. To propose Strategies on the basis of the study for integrating literacy and numeracy programmes into primary education(standard 1st to 7th )to prepare students for the 5IR.

## SAMPLE

Primary and Secondary sources are used for collecting the data.

## METHODES

Survey method is used for collection of primary and secondary data.



**COLLECTION OF THE DATA**

Secondary sources are used for the collection of the data for identifying literacy and numeracy skills essential for primary level students for participation in 5IR. The data is collected through documents, books, web pages etc. from their review of related literature different essential basic numeracy and literacy skills required at primary level (1st to 7th standard ) students for in 5IR are identified, and some strategies are suggested for integrating literacy and numeracy program into primary education to prepare students for the 5IR those are discussed under the objective wise procedure of the study.

Primary data is collected by analyzing present primary level education curriculum.

**Objective wise Procedure of the Research**

The first objective of the research is To identify the literacy and numeracy skills required by primary students essential for aligning with 5IR. For fulfilling this objective researcher has undertaken Indian and Aboard review of related literature regarding numeracy and literacy skills along with 5IR Context, these are - Ghosh. Lipi (2007)., Ball, Scott G Paris, Rangachar Govinda, (2014)., ASER (2018)., NEP (2020)., NAS, (2021)., Jessica David K. Evans and Susannah Hares (2021)., PISA ( 2022 )., Global Citizenship (2017)., NEP (2020)., NAS (2021)., PISA (2022)., ASAR (2023)., Sustainable Development Goals (2023)., etc. review regarding literacy and numeracy skills required

at primary level is undertaken and 5IR related review of related literature are Regenesys Business School (2020)., Sonawane Nikhil, (2023)., Patrick Noack (2023)., Stephanie M. Noble , Martin Mende , Dhruv Grewal , A. Parasuraman (2024). From these review of related literature it is seems that:

Due for 5IR tomorrow’s world is of cobots means collaboration with robots and hence it is the world of Automation, Robotization, Big data analytics, Smart systems, virtualization, Artificial Intelligence (AI), Machine Learning (ML), and the Internet of Things (IoT).

Hence today’s students required to well equipped with ICT skills comprising digital literacy skills, data processing skills, coding skills, collaboration skills along with Lifelong learning skills, Logical thinking skills, Creative thinking skills, ethical, environmental and cultural literacy these literacy and numeracy skills foundations should be laid down at primary level so the students can able to align in future with the 5IR.

Thus the first objective of the study is fulfilled and the second objective of the study is to study existing primary education level skills that aligns with 5IR requirements.

Therefore Maharashtra state Marathi medium primary education level curriculum’s analysis done as shown in table 1 for studying existing primary education level skills that aligns with 5IR requirements.

**Table 1: Maharashtra state Marathi medium primary education level curriculum’s analysis on primary education level skills**

Standard	subject	Learning outcomes	Required knowledge skills
पहिली	मराठी <a href="http://books.balbharati.in/pdfs/101000847.pdf">http://books.balbharati.in/pdfs/101000847.pdf</a>	1) Chats using own language or school medium language for various purposes. 2) They chat about the heard element, express their opinion. 3) Enjoys playing with sounds and sounds in language. 4) Can tell the difference between written material and pictorial material 5) Closely observes the visual and microscopic aspects of the picture	speech  speech  speech inspection  speech

		<p>6) Describes different events, actions and characters in the picture series by seeing them as one.</p> <p>7) Identifies the units of events, poems, letters/ words/sentences read.</p> <p>8) Makes predictions based on printed text in the area and its purpose.</p> <p>9) Identifies the letters and sounds of the alphabet</p> <p>10) They try to choose and read their favorite books outside of school and in school.</p> <p>11) Writing lesson listens and tries to write in his own way through the thoughts in his mind, according to the development level, pictures, horizontal</p>	<p>Observations</p> <p>inspection</p> <p>Reading</p> <p>Reading</p> <p>Writing practice</p> <p>creative writing</p>
1st	<p>English</p> <p><a href="http://books.balharati.in/pdf8/103030001.pdf">http://books.balharati.in/pdf8/103030001.pdf</a></p>	<p>1) learns and names English words for familiar objects and pictures.</p> <p>2) Recognize/identifies letters of the alphabets and their sounds correctly.</p> <p>3) Differentiates between small and capital letters in print.</p> <p>4) Sings/recites poems /rhymes with proper rhythm and actions.</p> <p>5) Listens and gives appropriate verbal/ non verbal responses.</p> <p>6) Understands the sequence of events and stories in simple narration.</p> <p>7) Carries out simple instructions ,commands and acts accordingly.</p> <p>8) Listens to English words ,greetings ,polite forms of expression ,simple sentences and responds in English or mother tongue.</p> <p>9) Speak about self/situation/pictures in English.</p> <p>10) Uses nouns such as 'boy', 'hen', 'rat' ,etc.</p> <p>11) Listens and enjoys fables and short stories.</p> <p>12) Identifies different shapes .</p> <p>13) Counts numbers up to 10 .</p> <p>14) Enjoys rhymes, songs and poems.</p> <p>15) Respond appropriately to commands given by teacher.</p> <p>16) Uses stock expressions in face to face interactions.</p> <p>17) Narrates /Enacts a familiar story or event.</p> <p>18) Associates words with pictures.</p>	<p>Identification of words</p> <p>phonetics</p> <p>small and capital words</p> <p>Recitation</p> <p>Verbal ,non verbal</p> <p>Responses</p> <p>Understanding</p> <p>Understanding</p> <p>Speaking</p> <p>Vocabulary skill</p> <p>Listening skill</p> <p>Understanding</p> <p>Listens for self content</p> <p>Understanding</p> <p>Understanding</p> <p>Speaking</p> <p>Reading</p>

<p>1st</p>	<p>Maths <a href="https://books.balbhharati.in/pdfOpen.aspx?itemid=103030004">https://books.balbhharati.in/pdfOpen.aspx?itemid=103030004</a></p>	<p>1)Works with numbers from 1 to 20 2)classifies objects into groups based on the shapes of the objects and size of the object 3) Recites number name and counts objects upto 20 4)counts objects using numbers 1 to 20 5)compares numbers up to 20 6)applies addition and subtraction of numbers 1 to 20 7) constructs addition facts using numbers up to 1 to 8) subtracts numbers using 1 to 9 9)solves day by day problems related to addition and subtraction of numbers up to 9 10) Recognizes numbers up to 99 and write numerals. 11) observes, extends and creates patterns of shapes and numbers 12)Collects ,records and interprets simple information by looking at different visuals (flowers, pens etc) 13)understands concept of zero</p>	<p>number reading classification recitation counting comparison addition addition subtraction addition subtractions writing numbers observation collection, interpretation, use of zero Substraction</p>
<p>2nd</p>	<p>Marathi <a href="http://books.balbhharati.in/pdfs/201030001.pdf">http://books.balbhharati.in/pdfs/201030001.pdf</a></p>	<p>1) Chat using own language or school medium language for various purposes. 2) Talk, poetry, listen carefully, tell in own language. 3) Talk about things seen, heard, stories, poems, etc. and express their reactions 4) They talk about what is happening around them and what they hear and see. 5) Creates words with rhythm and rhythm by enjoying the pronunciation of words and sounds. 6) They listen to stories and poems with their own imagination and add to it 7) According to their level and interests, they happily read stories, poems, pictures, posters, etc. and comment on them, asking questions. 8) Closely observes the microscopic and visual aspects of the picture. 9) Enjoys the events, actions and characters in a picture or picture series by understanding them as things. 10) Takes interest in familiar/unfamiliar texts and uses various strategies to find meanin</p>	<p>speech hearing, speech conversation conversation creative writing creative writing conversation inspection rasagrahana rasagrahana observation, reading Reading Additional reading writing Self-expression self-expression Imagination expansion</p>

		<p>11) Recognizes letters, words and sentences in written/printed text</p> <p>12)Alphabet identifies letters and sounds</p> <p>13) Read favorite books outside school and in school</p> <p>14) Do self-controlled writing</p> <p>15) Express the things heard in a different way in the form of pictures/words/sentences.</p> <p>16) Experiences from our life and surroundings permeate our writing.</p> <p>17) Complete the story/poem with own imaginatio</p>	
2nd	<p>Maths</p> <p><a href="http://books.balbharati.in/pdfs/203030004.pdf">http://books.balbharati.in/pdfs/203030004.pdf</a></p>	<p>1)Can carry out operations on two digit numbers up to 99</p> <p>2)can make tables of numbers 2,3,4,5 and use the tables</p> <p>3)can use place values of numbers while comparing two digit numbers</p> <p>4)tells and identifies greatest and smallest two digit numbers</p> <p>5)solves simple two digit number involving addition and subtraction of two digit numbers</p> <p>6)uses notes upto 100/- rs and coins</p> <p>7)names common tree digit numbers</p> <p>8)draws two dimensional diagrams of three dimensional objects</p> <p>9)can distinguish between straight and curved lines</p> <p>10)can draws vertical, horizontal, inclined ,straight lines</p>	<p>Writing numbers</p> <p>Tabulation,</p> <p>multiplication</p> <p>Comparison</p> <p>Comparison</p> <p>Addition, subtraction</p> <p>Counting application</p> <p>acquired knowledge</p> <p>Geometry</p> <p>sGeometry</p>
3rd	<p>Marathi</p> <p><a href="https://books.balbharati.in/pdfOpen.aspx?itemid=301020001">https://books.balbharati.in/pdfOpen.aspx?itemid=301020001</a></p>	<p>1) A story, a story, a poem, etc. is told in an understandable way</p> <p>Listens and reacts.</p> <p>2) Tells stories, poems, stories, with appropriate ups and downs at appropriate speed and in fluent language.</p> <p>3) They express their experiences, discuss and ask questions about the events and incidents that happened in the area.</p> <p>4) Understanding the literary genre and adding their own information to it Discussions, questions, opinions, etc. are given on the types of literature. Discusses with teacher, friends, gives written/oral answers to questions.</p>	<p>hearing, speech, self-expression</p> <p>Conversation, discussion, expression</p> <p>conversation, discussion, self-expression</p> <p>Gratitude, creative thinking</p> <p>Conversation writing, self-expression</p> <p>conversation, creative thinking</p> <p>Reading, reading for</p>

<p>3rd</p>	<p>MATHS <a href="http://books.balharati.in/pdfs/301020004.pdf">http://books.balharati.in/pdfs/301020004.pdf</a></p>	<p>6) After reading comprehensibly, they ask questions based on it, give their opinion, answer the questions asked orally, in sign language.</p> <p>7) New words introduced in different literature types, by understanding their meaning, ensure the meaning.</p> <p>8) Recognize the nuances of language in stories, poems, other literatures and use them properly.</p> <p>9) Read different types of text and ask questions based on it, discuss with teacher, friends.</p> <p>10) Write self-controlled</p> <p>11) Writes keeping in mind the writing format</p> <p>12) Punctuation is used consciously in writing</p> <p>13) Read different types of text and write your opinion on it, write answers to questions</p> <p>1) Performs mathematical operations on three-digit numbers.</p> <ul style="list-style-type: none"> <li>· 999 up to local price, read and use.</li> <li>· of numbers not exceeding 999.</li> </ul>	<p>comprehension</p> <p>Grammar, Rasagrahana</p> <p>reading comprehension</p> <p>writing</p> <p>creative writing</p> <p>grammar</p> <p>rational thinking</p> <p>Number reading and writing.</p> <p>Addition, subtraction, division</p> <p>rational thinking</p> <p>measurement</p> <p>measurement</p> <p>Measurement (Capacity)</p> <p>Measurement (Capacity)</p> <p>measurement,</p>
		<p>Handy addition, subtraction,</p> <ul style="list-style-type: none"> <li>· divided by the.</li> <li>· Makes bills of rates, schedules, contracts.</li> </ul> <p>2) Students understand two dimensional shapes.</p> <p>3) Measure length and distance using standard units like centimeter, meter.</p> <p>4) Objects are currently weighed using scales.</p> <p>5) Measurement ,capacitance is calculated.</p> <p>6)Compare the carrying capacity of the vessel with the help of unstandardized unit.</p> <p>7) Subtract sums involving grams, kilograms in daily life situations, events.</p> <p>8)Identifies specific days and dates in the calendar.</p> <p>9) Hours, days are arranged according to duration.</p> <p>10)The exact time is stated.</p> <p>11) Simple shapes, number series expand the motif.</p> <p>12) Observe, understand, draw symmetrical figures.</p> <p>13) Records information with the help of floor markings. Shape, picture. Show information, draw conclusions.</p>	<p>applied calculation</p> <p>Chronology</p> <p>Chronology</p> <p>Chronology (Deployment)</p> <p>shape bond</p> <p>Symmetry</p> <p>statistics</p>



Thus from table 1 it seems that at Maharashtra's Marathi medium primary education level curriculum emphasizes up to some extent on creative thinking, expressing, conversation, etc. skills and more on speaking, writing etc. skills. This curriculum is more emphasizing on numeracy and literacy skills and those are imparted through conventional methods of instruction transactions. Hence it seems that for aligning with 5IR there is requirement to revise the curriculum comprising basic foundational literacy and numeracy and literacy skills along with digital literacy skills, coding skills, collaborative skills.

Thus the second objective of the study is fulfilled and the third objective of the study is to propose Strategies on the basis of the study for integrating literacy and numeracy programmes into primary education to prepare students for the 5IR. For fulfilling this objective following suggestions are given on the basis of the study:

Certainly, incorporating reading and numeracy programs into primary education is critical for preparing pupils for the fifth Industrial Revolution (5IR). Here are study-based ways for effectively integrating these programs:

#### **Contextualized learning**

Create literacy and numeracy curricula that are contextually appropriate for the 5IR. Include real-world examples and scenarios involving technology, automation, and data-driven decision-making. This approach enables students to see the practical applications of literacy and numeracy in the changing workforce.

#### **Cross-curricular Integration**

Encourage collaboration among language arts and mathematics teachers to create integrated lessons that connect literacy and numeracy abilities. For example, students can examine and interpret data, make reports on technology breakthroughs, or solve mathematics problems involving 5IR ideas.

#### **Project Based Learning (PBL)**

Implement project-based learning initiatives that encourage students to use their literacy and numeracy skills to tackle complicated problems. Projects may include studying and presenting information on

emerging technologies, performing data analysis, or developing multimedia presentations that integrate both language and mathematical features.

#### **STEAM Education**

Integrate reading and numeracy programs within STEAM (Science, Technology, Engineering, Arts, and Mathematics) education. Create interdisciplinary projects that combine language abilities (reading, writing, and speaking) with mathematical principles and apply them to real-world STEAM applications.

#### **Digital Literacy Integration**

Integrate digital literacy into literacy programs by including tasks that challenge students to critically assess information, comprehend data visualizations, and communicate effectively using digital media. Integrate computational thinking and coding activities into numeracy programs to help students better comprehend mathematics in a technological environment.

#### **Real-world Problem Solving:**

Create literacy and numeracy classes based on real-world challenges related to the 5IR. This could include assessing data sets relating to technological trends, reading and comprehending automation articles, or solving mathematical issues in robotics and artificial intelligence.

#### **Data-driven Literacy**

Incorporate data literacy skills into literacy programs by teaching students how to successfully comprehend and communicate with data. This involves comprehending graphs, charts, and statistical data, which are critical for making educated decisions in the 5IR.

#### **Inclusive and Differentiated Instruction**

Recognize and accommodate various learning styles and abilities. Implement individualized instruction strategies to meet individual literacy and numeracy requirements. This ensures that all students, regardless of learning profile, may obtain the necessary abilities for the 5IR.

#### **Continuous Professional Development for Teachers**

Provide continual training and professional development opportunities for teachers to improve their reading and

numeracy skills within the framework of the 5IR. This includes remaining current with new educational tools, teaching methods, and multidisciplinary approaches.

### Global and cultural literacy

Integrate global and cultural literacy into curriculum, exposing pupils to varied perspectives and technology advancements from around the world. This gets students ready for the global character of the 5IR workforce.

### Assessment Strategies

Create examinations that examine both reading and numeracy skills in the 5IR environment. Use a variety of assessment approaches, such as performance-based assessments, portfolios, and project evaluations, to measure students' ability to apply these skills in real-world circumstances.

### Parental and Community Involvement

Encourage parents and the community to boost reading and numeracy development. Provide tools and courses to help parents understand the significance of these abilities in the 5IR and how to promote learning at home.

By following these ideas, primary education may effectively provide kids with the reading and numeracy abilities they need to flourish in the Fifth Industrial Revolution.

The third objective of the study is fulfilled.

## CONCLUSION

1. State board Maharashtra Marathi medium primary level text books emphasis on linguistics skills like reading, writing, speaking, conversation, reading for comprehension, Creative Thinking, self expression,
2. State board Maharashtra Marathi medium primary level textbook emphasis on numeric skills like number reading and writing, addition, subtraction multiplication, division, rational thinking, measurement, application of acquired knowledge, chronology, patterns, Symmetry, statistics, calendar and time, Measurement etc.
3. State board Maharashtra Marathi medium primary level textbook doesn't include any chapter on digital literacy skills.

4. State board Maharashtra Marathi medium primary level textbook provides some web page links and some QR codes for references to concerning topics.

With the help of that web page links QR codes extra information related to concerning topic would be read or watch on YouTube in the form of text or videos.

## SUGGESTIONS

Following suggestions are given on the basis of research

1. State Government of Maharashtra Marathi medium primary level textbook emphasize on basic numer and literacy skills. For aligning the with 5th industrial revolution curriculum should be revised comprising foundational literacy and numeracy skills along with digital literacy skills like coding skills and collaborative skills.
2. Some strategies should be introduced or include in the curriculum of State Government of Maharashtra Marathi medium primary level, these are contextualized learning, cross curricular integration, project based learning, STEAM (science, Technology, Engineering, Arts, Mathematics )education, digital literacy integration, Real world problem solving, data driven literacy, etc
3. State Government of Maharashtra Marathi medium primary level text book should introduce some basic digital literacy topics to enhance digital literacy such as
  - A) basic computer skills
  - B) internet safety
  - C) introduction to coding
  - D) critical thinking and problem solving
  - E) digital citizenship
  - F) introduction to robotics
  - G) digital creativity
  - H) adaptability and life long learning

By integrating these topics in primary level Maharashtra states Marathi medium curriculum students can develop their digital literacy skills and life skills which are useful in the future era of the fifth industrial revolution.

## REFERENCES

1. ASER (2022). 'Annual status of Education Report Retrieved December 30, 2023, from <https://img.asercentre.org/docs/ASER%202022%20report%20pdfs/All%20India%20documents/aserreport2022.pdf>
2. Ball, J., Paris, S.G., Govinda, R. (2014). Literacy and Numeracy Skills among Children in Developing Countries. In: Wagner, D.A. (eds) Learning and Education in Developing Countries: Research and Policy for the Post-2015 UN Development Goals. Palgrave Pivot, New York. Retrieved December 30, 2023, from [https://doi.org/10.1057/9781137455970\\_2](https://doi.org/10.1057/9781137455970_2)
3. David K. Evans and Susannah Hares (2021). Should Governments and Donors Prioritize Investments in Foundational Literacy and Numeracy? Retrieved December 30, 2023, from <https://www.cgdev.org/sites/default/files/Should-governments-and-donors-prioritize-investments-FLN.pdf>
4. Foundational Literacy and Numeracy Assessment. (2023). Journal of Pharmaceutical Negative Results, 2944-2953. December 30, 2023, from <https://doi.org/10.47750/pnr.2023.14.02.347>
5. Ghosh, Lipi (2007). Foundational Literacy and Numeracy In West Bengal. Vol. LVI no. December 30, 2023, from [https://www.researchgate.net/profile/Lipi-Ghosh-2/publication/351056610\\_Foundational\\_Literacy\\_and\\_Numeracy\\_in\\_West\\_Bengal/links/6081a4572fb9097c0c01c93d/Foundationalliteracy-and-Numeracy-in-West-Bengal.pdf](https://www.researchgate.net/profile/Lipi-Ghosh-2/publication/351056610_Foundational_Literacy_and_Numeracy_in_West_Bengal/links/6081a4572fb9097c0c01c93d/Foundationalliteracy-and-Numeracy-in-West-Bengal.pdf)
6. Goren Heela, Yemini Miri,(2017). Global Citizenship Education Redefine –A Systematic Review of Empirical Studies On Global Citizenship Education. Retrieved December 30, 2023, from <https://www.sciencedirect.com/science/article/abs/pii/S0883035516308163>
7. MHRD.(2020). National Education Policy -NEP 2020. December 30, 2023, from [www.education.gov.in](http://www.education.gov.in)
8. Murrey, Jane (2021). Literacy is inadequate: young children need literacies. Retrieved December 30, 2023, from <https://www.tandfonline.com/doi/full/10.1080/09669760.2021.1883816>
9. NAS,(2021). National Achievement Survey report card. Retrieved December 30, 2023, from <https://nas.gov.in>
10. NCERT.(2017). DIKSHA, Retrieved December 30, 2023, from <https://diksha.gov.in>
11. Patrick Noack (2023). The Fifth Industrial Revolution: where mind meets machine. Retrieved December 30, 2023, from <https://www.thenationalnews.com/opinion/comment/the-fifth-industrial-revolution-where-mind-meets-machine-1.1061280>
12. PISA (2022). Technical Report. Retrieved December 30, 2023, from <https://www.oecd.org/pisa/data/pisa2022technicalreport/PISA-2022-Technical-Report-Ch-01-PISA-Overview.pdf>
13. Regenesys Business School (2020). The Fifth Industrial Revolution (5IR) and how it will change the business landscape. <https://www.regenesys.net/reginsights/the-fifth-industrial-revolution-5ir>
14. Sonawane Nikhil, (2023). Industry 5.0: The Fifth Industrial. Retrieved January 25, 2023, from Revolution. <https://enterprisetalk.com/featured/industry-5-0-the-fifth-industrial-revolution-5ir>
15. Sustainable Development Goals. (2023). System of Environment Economic Accounting. Retrieved December 30, 2023, from <https://seea.un.org/content/sustainable-development-goals>
16. UGC,(2020). Salient features of NEP 2020. December 30, 2023, from <https://www.ugc.ac.in>

# Contribution of the Fifth Industrial Revolution to the Achievement of the Sustainable Development Goals

**Yogesh Khanderao Patil**

Assistant Professor  
Teachers College Aranyeshwar  
Pune, Maharashtra  
✉ yogaru17@gmail.com

## ABSTRACT

Compared to previous industrial revolutions, the fifth industrial revolution is not only concerned with significant changes in production processes and social structures, but also human health welfare, environmental sustainability, quality education for all, inclusive economic growth, a trend towards reducing inequality, inclusive economic growth, renewable and cheap energy generation. and peace and social justice etc. The Fifth Industrial Revolution has the potential to meet the Sustainable Development Goals.

**KEYWORDS** : *Fifth Industrial Revolution, Sustainable Development Goals.*

## INTRODUCTION

The 5th Industrial Revolution is an industrial revolution in which society interacts with technology that prioritizes the well-being of humanity and the planet, not just economic progress. The Fifth Industrial Revolution represents a transformational era in which technological advances combine with a commitment to increasing global well-being and environmental sustainability. As we stand at the crossroads of unprecedented technological progress, the United Nations has created an all-encompassing framework, the Sustainable Development Goals, to address global challenges. Through the Fifth Industrial Revolution, we need to make efforts to face the global problems, to solve them. This article explores the fifth industrial revolution and how the SDGs can be achieved. We will see information about this. The focus is on how innovation and sustainability can be synergized to create a better future for humanity as a whole and for the planet.

## DEFINITION OF FIFTH INDUSTRIAL REVOLUTION

The term Industrial Revolution is primarily associated

with significant changes in production processes and social structures, however the Fifth Industrial Revolution emphasizes the merging of the physical, digital and biological realms. This is an important feature that distinguishes itself from all the previous four industrial revolutions. It is imperative that artificial intelligence is harnessed to create a more inclusive sustainable and just world enabled by cutting-edge technologies such as blockchain, nanotechnology and biotechnology.

## SUSTAINABLE DEVELOPMENT GOALS

As of August 15, 193 countries have endorsed the following 17 goals.

1. Poverty Eradication - Eradication of poverty in all its forms, everywhere.
2. Hunger Eradication – Eradicating hunger, achieving food security and improved nutrition and promoting sustainable agriculture.
3. Good Health - Ensuring a healthy life and helping people of all ages to maintain health.
4. Quality Education – To ensure inclusive and appropriate education for all and to help all to have access to lifelong learning.

5. Gender Equality – Achieving gender equality and empowering all women and girls.
6. Clean Water and Sanitation – Ensuring and providing access to water and sanitation for all.
7. Renewable and affordable energy – ensuring access to affordable, reliable, sustainable and modern energy for all.
8. Good Jobs and Economics - To promote sustained, inclusive and sustainable economic growth, full and productive employment/employment and decent work for all.
9. Innovation and Infrastructure - Different wording needed: Building resilient infrastructure, supporting inclusive and sustainable industrialization and innovation that support growth.
10. Reduction of Inequality - Reduction of inequality within all countries and between countries.
11. Sustainable cities and settlements - Making cities and human societies inclusive, safe, responsive and sustainable.
12. Responsible use of available resources – ensuring sustainable consumption of resources and production pattern.
13. Impact of Climate - Taking immediate measures to mitigate climate change and its effects.
14. Sustainable Oceans - Conserving and sustainably using oceans, seas, and marine resources for sustainable development.
15. Sustainable use of land - Different wording required: Protecting the ecological organization of land, restoring it, promoting its sustainable use, sustaining forest management, preventing deforestation, stopping soil erosion and restoring eroded land and preventing loss of biodiversity. to stop
16. Peace and Justice – Promoting peaceful and inclusive societies for sustainable development, justice for all, effective, accountable and inclusive institutions at all levels
17. Partnership for Sustainable Development – Strengthening approaches to achieving sustainable development and revitalizing global partnerships.

### **Interrelationship between Sustainable Development Goals and Fifth Industrial Revolution:**

#### **Inclusive Economic Growth (SDGs-1)**

The fifth industrial revolution has the potential to create many new industries and employment opportunities, mainly due to the adoption of automation and smart technologies. The use of new technology can increase production on a large scale in a short period of time thus allowing man to focus on higher human values in his life. It gives an opportunity to enjoy human life in a new way. As per the Sustainable Development Goals (SDGs-8), governance and industry are expected to collaborate to promote good practices, ensuring that the benefits of innovation are distributed equally.

#### **Health and Wellbeing (SDGs-3)**

A rapidly growing population is increasingly suffering from a variety of different diseases. With the integration of biotechnology and artificial intelligence in healthcare, personalized medicine, rapid diagnosis, telemedicine, remote patient monitoring, wearable devices are becoming integral components of healthcare delivery. Hence, addressing the disparities in health care through the Fifth Industrial Revolution is playing an important role in achieving Sustainable Development Goal number three.

#### **Quality Education for All (SDGs-4)**

The Fifth Industrial Revolution has the potential to address educational inequality through the use of technology. Virtual Reality, Augmented Reality, Artificial Intelligence powered personalized learning, the ability to provide quality education to individuals across the world in different platforms is the fifth industrial revolution. However, as technology evolves, it is necessary to be ready to provide skills.

#### **Renewable and Affordable Energy (SDGs-7)**

Smart grids, energy storage solutions as well as the integration of renewable energy sources represent the fifth industrial revolution's approach to energy. By prioritizing clean energy technologies, the fifth industrial revolution is felt to reduce the carbon footprint of individuals as well as society. According to SDGs-7, which ensures the generation of renewable and cheap energy, this seems to follow indirectly on the climate impact (SDGs-13).



**Reducing inequality (SDGs-10)**

The fifth industrial revolution has the potential to reduce the economic and social gaps in society due to the increased availability of information resources and opportunities. Reducing Inequalities in the Sustainable Development Goals (SDGs-10) Some features of the Fifth Industrial Revolution are valuable as a solution to the challenge of reducing inequality within and between countries.

**Environmental Sustainability (SDGs-12,15,14)**

Compared to previous industrial revolutions, the fifth industrial revolution's important and key feature is its ability to reduce environmental degradation. The fifth industrial revolution has many features including sustainable energy use, circular economy, sustainable production and promotion of sustainable consumption. The fifth industrial revolution works effectively.

**Peace and Justice (SDGs-16)**

In the fifth industrial revolution, the communication system has improved tremendously. Global connectivity has been facilitated by advanced communication technology. Many communication barriers have been removed. This increases multicultural understanding. Multiple social media platforms as well as emerging technologies are playing an important role in bringing people together for social good as well as addressing global challenges. The resources of the Fifth Industrial

Revolution can be used to promote international cooperation for promoting peace and justice, prioritizing ethical practices, and responsible innovation. Also, the fifth industrial revolution is becoming important to prevent bias and discrimination, to set transparent policies, to promote ethical standards in emerging technologies, to increase international cooperation, to promote the creation of a peaceful and just society.

In summary, as above, the fifth industrial revolution creates opportunities directly and indirectly for the achievement of sustainable development goals, only in the current situation, humans need to use it in a positive way, which is expected to benefit the entire human race and the planet earth.

**REFERENCE**

1. [https://en.wikipedia.org/wiki/Corporate\\_social\\_responsibility](https://en.wikipedia.org/wiki/Corporate_social_responsibility)
2. [https://mr.wikipedia.org/wiki/%E0%A4%B6%E0%A4%BE%E0%A4%B6%E0%A5%8D%E0%A4%B5%E0%A4%A4\\_%E0%A4%B5%E0%A4%BF%E0%A4%95%E0%A4%BE%0%A4%B8\\_%E0%A4%A7%E0%A5%8D%E0%A4%AF%E0%A5%87%E0%A4%AF%E0%A5%87](https://mr.wikipedia.org/wiki/%E0%A4%B6%E0%A4%BE%E0%A4%B6%E0%A5%8D%E0%A4%B5%E0%A4%A4_%E0%A4%B5%E0%A4%BF%E0%A4%95%E0%A4%BE%0%A4%B8_%E0%A4%A7%E0%A5%8D%E0%A4%AF%E0%A5%87%E0%A4%AF%E0%A5%87)
3. <https://www.encyclopedia.com/social-sciences-and-law/economics-business-and-labor/economics-terms-and-concepts/entrepreneur>
4. <https://unesdoc.unesco.org/ark:/48223/pf0000265760>

# Entrepreneurship Skills in School Students of Goa -A Study

**Khushali U. Prabhu**

✉ prabhukhushali@gmail.com

**Asawari Ashtekar**

✉ asawari3183@gmail.com

**Renuka A. Pardesi**

✉ renukacbed@gmail.com

**Siena Fernandes**

✉ sienafernandes29@gmail.com

Assistant Professor  
HPSM's Ganpat Parsekar College of Education  
Harmal Goa

## ABSTRACT

In the rapidly evolving global economy entrepreneurship skills are increasingly recognized as essential competencies for individuals. The modern society demands individuals who can think creatively, adapt to change, and seize opportunities. Integrating entrepreneurship education into schools has become a pivotal strategy to equip students with the mindset, knowledge, and skills necessary for success in a dynamic and competitive world. The NEP 2020 expects that education should cultivate Entrepreneurship qualities by promoting critical thinking, problem-solving, and innovation. Integrating entrepreneurship skills into school curricula fosters a spirit of initiative and a proactive approach to career development. Students are empowered to identify and pursue their passions, turning ideas into action. This paper highlights the benefits of entrepreneurship education, its Challenges encountered by the teachers in incorporating entrepreneurship education and measures to develop entrepreneurship through experiential learning activities, such as business simulations, mentorship programs, and real-world projects from which students gain practical insights into the entrepreneurial process. Collaborations with local businesses, entrepreneurs, and industry experts create authentic learning experiences, bridging the gap between theory and practice. The incorporation of technology and digital platforms further enhances the accessibility and effectiveness of entrepreneurship education in schools.

**KEYWORDS** : *Entrepreneurship skills, School students, Teachers' role, Family support, Self reliance, Social mobility.*

## INTRODUCTION

Entrepreneurship revolution in India played a crucial role in the late 20th and early 21st century by the effect of various practices. During the British colonial rule, entrepreneurship in India was localized and focused on traditional industries such as trading, agriculture and handicrafts. The British often exploited the resources for the benefit of the British Empire instead of hosting indigenous entrepreneurship.

A few initiatives that directly influenced entrepreneurship education in India are as follows:-

1. Technical and Vocational education
2. Establishment of Education system

3. Introduction of Western Business Practices
4. Encouragement of Industrialization
5. Promotion of Trade and Commerce

All the above initiatives were taken by Britishers to generate a workforce that helped them to work for their colonial economy. They have provided education by having a primary aim to serve the colonial economy, which helped the Indians to develop practical skills and knowledge relevant to the entrepreneurship sectors. Overall, the British colonial rule in India affected the education system.

We can divide it into Before and After independence.

Before independence- Jamshedji Tata and Ardeshir

Godrej were the two well-known names before the independence era who dominated with traditional industries on India.

After independence- India underwent major economic reforms along with the policy changes that impacted entrepreneurship sectors. During the 1950s and 1960s, public sector enterprises played a crucial role. During this period, private entrepreneurs did not have flexibility, while heavy rules and regulations became the hurdles in their work.

Whereas, in the 1980s and 1990s, the private entrepreneurs' condition was slowly changing. Economic reformers were done in such a way that it helped in the smooth functioning of private entrepreneurs.

### **Role of Education in Development of Entrepreneurship Skills**

Education plays a crucial role in social development. Social economic development of a country depends upon the educated people of the society. Through education, entrepreneurship skills can be developed in the students. Entrepreneurship education is a transformative approach which instils a sense of social responsibility, encouraging students that equip them with the mindset and abilities needed for success in the 21st-century world. Educators play a crucial role in facilitating entrepreneurship education, requiring professional development opportunities and innovative teaching methodologies. As the education plays such an important role in development of entrepreneurs, the researchers have undertaken the study to analyse the present status of Goa school education in development of entrepreneurship skills of in school students.

### **RESEARCH QUESTIONS**

1. What are the views of schoolteachers in Goa toward entrepreneurship?
2. How do teachers impart entrepreneurship skills through their subject?
3. Which are the best practices at schools in Goa that supports entrepreneurship skills among students?

With these research questions, the researchers have done the study entitled "Entrepreneurship skills in school students of Goa -A study."

### **OBJECTIVES OF THE STUDY**

1. To analyse the views of school teachers in Goa towards entrepreneurship.
2. To analyse the reflections of teachers in imparting entrepreneurship skills through their subject.
3. To analyse the best practices at schools in relation to develop entrepreneurship skills among students' from Goan students.

### **REVIEW OF RELATED LITERATURE**

Following are some reviews of literature and research considered for the study pertaining to Indian context. Entrepreneurship education has gained significant attention in recent years, as researchers and educators recognize its potential to foster entrepreneurial skills in students. Ahmad and Abubakar (2016) conducted a study to assess the effects of entrepreneurship education on students' entrepreneurial intention. Their findings indicated a positive relationship between entrepreneurship education and students' intention to become entrepreneurs. Similarly, Hatak, Harms, and Fink (2015) found that entrepreneurship education positively influences students' entrepreneurial self-efficacy and entrepreneurial intentions. These studies emphasize the importance of entrepreneurship education in equipping school students with the necessary skills and mindset to pursue entrepreneurial endeavors. The development of an entrepreneurial mindset is a key aspect of fostering entrepreneurship skills in school students. Johnson and Ali-Knight (2015) conducted a study that examined the factors influencing the development of entrepreneurial mindset in undergraduate students. The results suggested that entrepreneurial self-efficacy, role models, and exposure to entrepreneurial experiences significantly contribute to the development of an entrepreneurial mindset. Similarly, Dyer (2019) explored the role of mindset in developing entrepreneurial skills. The study found that fostering an entrepreneurial mindset positively influences students' creativity, innovation, and problem-solving abilities. These findings underscore the significance of cultivating an entrepreneurial mindset in school students to enhance their entrepreneurial skills. Entrepreneurial skills not only prepare school students for future entrepreneurial endeavours but also benefit

their overall career development. Shinnar et al. (2012) investigated the relationship between entrepreneurship education and subsequent career choices and outcomes. The study revealed that students exposed to entrepreneurship education were more likely to pursue entrepreneurial careers and had higher levels of job satisfaction and financial success. Similarly, Fayolle et al. (2014) examined the impact of entrepreneurship education on students' career paths. The findings indicated that entrepreneurship education positively influenced students' career choices, with a considerable number of students opting for self-employment or related industries. These studies emphasize the long-term benefits of entrepreneurial skills for school students' career success. A study by Rahman et al. (2015) highlights the importance of developing entrepreneurial skills early on, suggesting that entrepreneurship education fosters creativity, problem-solving abilities, and innovative thinking in students. Moreover, the research emphasizes the necessity of entrepreneurship education given the dynamic nature of the Indian economy, which demands individuals to be adaptable and proactive. Misra and Datta (2018) found that students who underwent entrepreneurship training exhibited higher self-esteem, self-confidence, and motivation to become entrepreneurs. Additionally, these students displayed a greater ability to identify business opportunities and were more likely to engage in entrepreneurial behaviour. Singh and Sharma (2017) propose an action-based learning methodology to enhance entrepreneurial competency. They argue that experiential learning, such as creating business plans and engaging in real-life entrepreneurial activities, can effectively develop entrepreneurial attitudes and skills among students. Similarly, a study by Sequeira et al. (2019) suggests the use of technology-based platforms to cultivate entrepreneurial skills, offering online courses and simulations that provide students with practical training and exposure to real-world entrepreneurial scenarios.

From above review of literature it is highlighted that the importance of entrepreneurship education to equip school students in India with essential skills for professional success. Findings indicate that entrepreneurship education positively influences students' self-confidence, motivation, and ability to

identify and pursue entrepreneurial opportunities. Action-based learning and technology-based platforms are recommended as effective approaches for teaching entrepreneurship skills. With the growing emphasis on fostering entrepreneurship in India, further research is warranted to explore the long-term impact of entrepreneurship education on school students' career outcomes.

## RESEARCH METHODOLOGY OF THE STUDY

This study was done by using Survey Method. Purposive sampling method consisting of 129 teachers from 95 schools of Goa from rural and urban area was selected. A questionnaire was prepared through Google form consisting of 24 closed, open questions and semi-structured questions were used.

### Sample for the Study

129 teachers from 95 schools from rural and urban area of Goa were selected.

### Data Collection

Data was collected by using Google form consisting questionnaire of altogether 24 closed, open questions and semi-structured questions was used.

### Data Analysis

Data was analysed by using qualitative approach in which grounded theory method of data analysis.

### Results of the Study

1. Majority of the teachers are of the opinion that the Entrepreneurship skills in school curriculum does not support in current school curriculum.
2. Most of the teachers has confidence in their ability to incorporate real-world examples of entrepreneurship into their teaching methods.
3. Different subject teachers have different challenges as given below-
  - i. The Language teacher: - Most of the teachers are of the opinion that they find difficulty in incorporating entrepreneurship content in their teaching-learning process.
  - ii. Difficulty in assessment and evaluation of the

content: - some topics are abstract and hence diffusion of Entrepreneurship skill content is difficult.

- iii. Lack of time and resources to incorporate Entrepreneurship content. If at all we incorporate only theoretical part will be covered and no practical experiences will be provided to the students.
- iv. Teachers are of opinion that they are involved more in clerical job which affects the teaching-learning process.
- v. According to School teachers they should be provided with Leadership, Business management, Time management, Creative thinking, Soft Skills such as communication, teamwork, Problem solving.
- 4. Teachers are of opinion that they should be trained to handle entrepreneurship development programme effectively.
- 5. According to teacher in order to develop entrepreneurship among school students' activities such as talk by the successful businessman, owner of successful startups should be arranged, Exhibition cum sale of various items made by students should be organised at school level (Bazaar Day), taluka and state level, visit to different establishment, In the line of Mock Parliament Mock business enclave can be arranged.
- 6. Teachers are of opinion that to foster entrepreneurship extra-curricular activities such as entrepreneurship clubs, workshops can significantly contribute.
- 7. The school should actively collaborate with local businessman and entrepreneurs for understanding real world entrepreneur challenges.
- 8. All teachers believe that promoting innovation and creative thinking in school activities contributes positively to the development of entrepreneurship skills.
- 9. Most of the teachers of opinion that assessments at the school level should include components that evaluate students' entrepreneurial competencies and practical application of business concepts.
- 10. Most of the teachers are of believe that schools

should organize events like business fairs or competitions to provide students with platforms to showcase and further develop their entrepreneurial skills.

- 11. Most of the teachers are of believe that schools should provide holistic approach, combining both theoretical knowledge and practical experiences, is essential for effectively nurturing entrepreneurship skills at the school level.
- 12. Most of the teachers are of believe that Robotics/ Coding can foster the entrepreneurship skill in school students.
- 13. Most of the teachers are of believe that NSQF (National Skill Qualification Framework) can foster the entrepreneurship skill in school students.
- 14. School teachers shared that Bazar Day, Christmas Stalls, Science Project Prototype, Marketing, Robots and Coding, Reading, Effective Business Strategies
- 15. Teachers are of opinion that entrepreneurship skills can be incorporated in the following subjects such as Market Research, Economic, Work Experience, Planning Management and Leadership, Comparing Quantities topic, Computer education, Geography, Logistic, History, Science
- 16. Teachers suggested that NSQF, Use of proper Coding, by teaching new skills, by introducing entrepreneurship subjects, by providing practical experiences, by conducting such activity in every school, by working on syllabus, by conducting competitions and taking experience-based ideas from the students, experience learning, coding classes, working on % part of theory and practical, designing new ideas based by providing experiences.

**CONCLUSIONS**

Entrepreneurship is new to the school education system. This study concludes that to inculcate entrepreneurship skills in today's and future school students' generations we need to provide different opportunities to explore the entrepreneurship skills among the students and encourage them to explore the real-world experiences which will motivate to develop start-ups, venturing



into real world experiences by giving them opportunity to attend internship programmes in well-established business houses.

However, entrepreneurship skills in students, teacher should be trained accordingly so that they can give proper guidance to students to attain minimum skill of entrepreneurship. Through experiential learning activities, such as business simulations, mentorship programs, and real-world projects from which students gain practical insights into the entrepreneurial process. Collaborations with local businesses, entrepreneurs, and industry experts create authentic learning experiences, bridging the gap between theory and practice. The incorporation of technology and digital platforms further enhances the accessibility and effectiveness of entrepreneurship education in schools.

## REFERENCES

- Ahmad, A. A., & Abubakar, N. A. (2016). Entrepreneurship education and entrepreneurial intention among secondary school students in Nigeria. *International Journal of Innovative Research and Development*, 5(3), 364-372.
- Creswell, J. W. (2011). *Educational Research: Planning, Conducting, and Evaluating Quantitative and Qualitative Research*. Boston: Pearson.
- Dyer, L. (2019). Developing the entrepreneurial mindset: Entrepreneurship education enhances student creativity, innovation, and problem solving. *Journal of Entrepreneurship Education*, 22(2), 1-13.
- Fayolle, A., Gailly, B., & Lassas-Clerc, N. (2014). Assessing the impact of entrepreneurship education programs: A new methodology. *Journal of Small Business Management*, 52(2), 261-284.
- Hatak, I., Harms, R., & Fink, M. (2015). Disentangling the impact of entrepreneurial orientation on the performance of service business ventures: A longitudinal study. *Entrepreneurship Theory and Practice*, 39(5), 1027-1052.
- Johnson, L. W., & Ali-Knight, J. (2015). Influential factors on the development of undergraduate students' entrepreneurial mindset. *Journal of Small Business and Enterprise Development*, 22(3), 527-545.
- Misra, S., & Datta, S. K. (2018). Entrepreneurship education in Indian schools and its impact on entrepreneurial intentions of students. *Journal of Education and Practice*, 9(15), 37-44.
- National Education Policy (2020). Ministry of Human Resource Development Government of India. Retrieved from [https://www.education.gov.in/sites/upload\\_files/mhrd/files/NEP\\_Final\\_English\\_0.pdf](https://www.education.gov.in/sites/upload_files/mhrd/files/NEP_Final_English_0.pdf)
- Rahman, M. M., Islam, M. A., Rahman, M. M., & Hossain, A. (2015). Importance of entrepreneurship education and training for the new graduates in India. *International Journal of Learning and Development*, 5(2), 53-61.
- Sequeira, A. H., Patel, S. D., & Fernandes, G. L. (2019). The role of technology in advancing entrepreneurship education: Reflections on an Indian experience. *International Journal of Education and Development using Information and Communication Technology*, 15(4), 75- 86.
- Shinnar, R. S., Hsu, D. K., & Powell, B. C. (2012). Self-employment intention among college students: Implications for entrepreneurship education and training. *Entrepreneurship Theory and Practice*, 36(2), 389-406.
- Singh, B., & Sharma, R. (2017). Fostering entrepreneurial competency among students: Action-based learning. *International Journal of Research in Management, Science & Technology*, 5(2), 164-172.

# Case Study of Goa Vidyaprasarak Mandal, Ponda Goa

**Uma Patil**

M. Ed, Student

Dr. Dada Vaidya College of Education

Farmagudi Ponda. Goa

## ABSTRACT

This paper review the effectiveness of the school management. Present study is on Goa Vidyaprasarak Mandal working in the field of education in Ponda Taluka,Goa. It has contributed to a large extent for the development of the society. G.V.M. is one of the biggest management in Goa located in Ponda taluka which caters from K.G. to P.G level. In this presentation it's historical background, academic development, work methodology, present status, (number of students, staff, student teacher ratio) & innovation in teaching learning process is focused. Noteworthy contributions of the G.V.M's in education is also highlighted.

Goa Vidyaprasarak Mandal works for the welfare of the society since 1911 ( 112 years from its establishment ). Number of dedicated people have worked under them. It works on it's framed constitution rules and regulations. This management has two bodies:- General body and Working Committee. On which working of management depends. At present G.V.M. has seventeen institutions. It has grown in leaps and bounds. The management has its own rules and regulations for the the smooth functioning of the administration of the various institutions of the G.V.M. Challenges faced by the management is also focussed.

This study of exemplary management will definitely guide other educational institutions as a role model.

**KEYWORDS** : *General body, Working committee, Constitution.*

## INTRODUCTION

**R**ole of Education in Sustainable Development

*“Education is a human right with immense power to transform. On its foundation rest the cornerstones of freedom, democracy and sustainable human development”* Kofi Annan

Education is an essential tool that provides any possible knowledge to human beings and allows everyone to obtain the knowledge, skills, attitudes and values necessary to shape the future in a more sustainable way. One of the main focus is here is to educate the younger generation by developing a sense of responsibility for the environment. As youngsters are the heart of sustainable development in the future, whether to achieve it or not--it all depends on them. Education for sustainable development is able to cultivate the youngster's mindset by inducing the concept of living in a sustainable

lifestyle. It not only helps the children to promote a sustainable lifestyle but also allowing them to be more socially concerned about the environment. Education is an essential component of achieving sustainability. All over the world, societies are coming to recognize that current development trends are not sustainable, and that public awareness through education and training is a key element to move our increasingly globalized society towards achieving sustainability. Education is recognised as having one of the highest long-term returns on investment of all development goals.

Keeping this aim in mind Goa Vidyaprasarak Mandal has always been 'Need focused rather than Publicity' .

### About Research Paper

This research is in - depth study of Goa Vidyaprasarak Mandal. With respect to background ,working, functioning and administration.

Goa Vidyaprasarak Mandal ( G.V.M.) originally named as 'Liga da Propoganda de Instrucao em Goa'. A leading educational institution in Goa. It has over the years shaped the lives of thousands of students.

This management is well planned and functions very neatly for the welfare of the people with a vision to cater to the fundamental educational needs of children from urban as well as rural area.

## BACKGROUND

Pranacharya Dr.Ramchandra Pandurang Vaidya was the greatest of the thinker and the social reformer of his times. He along with Shri Sitaram Vishwambhar Kerkar and Shri Vinayak Ramchandra Bhat Sirjyotishi founded 'Goa Vidyaprasarak Mandal' then known as ' Liga da Propoganda de Instructor em Goa' founded on 2 nd October 1911.Which was an auspicious day of Vijayadashami and incidently the birth date of Mahatma Gandhi and Lal Bahadur Shastri.

Dada Vaidya spelt the aim as follows:-

“LET THE IGNORANT BE WISE, LET THE ILLITERATE BE LITERATE,

LET THE LITERATE BE EDUCATED,LET THE EDUCAED BE THINKER,LET THE THINKERS TRANSLATE THEIR THUIGHTS INTO ACTION AND THUS DO AWAY WITH IGNORANCE, POVERTY AND HELPLESSNESS.

G.V.M.'s first educational institution A.J.de Almeida High School then known as ' Antonio Jose de Almeida ' was founded by Dr Dada Vaidya ,Shri Sitaram Kerkar and Shri Vinayak Ramchandra Sirjyotishi. The colegio was named after Dr.Antonio Jose de Almeida,the Republican leader in Portugal,who championed the cause of the Goans.

Goa was then passing through difficult colonial phase as the entire territory of Goa was under Portuguese fortunately, establishment Of Republic in Portugal in the year 1910 created the window of opportunity for the Goan community to establish their own institutes. Though Liga de Propoganda de Instructor em Goa named it's first institution, Colegio Antonio Jose de Almeida.

## Men Who Mattered

DR. Balkrishna Dattaram Sinai Sakhardande Adv. Vinayak H. Kaisare

Shri Vithal Vishnu Sinai Dempo

Dr. Dhulba Shivaji Naique Pratap Rao Sar Desai Shi Sitaram Vishwambhar Sinai Kerkar

Dr. Ramchandra Pandurang Vaudya

Shri Vinayak Ramchandra Bhat Sirjyotishi Dr. Devdatta Kerkar.

## Aim of Goa Vidyaprasarak Mandal

Goa Vidyaprasarak Mandal works always for the welfare of the society since it's inception in 1911. Keeping this aim in mind that people of Ponda and Suburban villages should get good access Shri Bhaskar Khandeparkar, the President of General body, G.V.M. said that 'Efforts of G.V.M. has always been need focused rather than Publicity'.

## Management of Goa Vidyaprasarak Mandal

Management of G.V.M. run on the framework of the constitution.

Goa Vidyaprasarak Mandal has its constitution since 1917 and than it was re- drafted in the year 1965.

As per the constitution G.V.M. has two committees

1. General Body consists of 300 members
2. Working Committee consists of 5 members

General body consists of all members of Goa Vidyaprasarak Mandal. It is a general assembly of all members. It has certain important tasks under the constitution. Whereas the Working Committee looks after the day today working of Goa Vidyaprasarak Mandal 's various institutions.

Goa Vidyaprasarak Mandal was registered under the society act 1960. It is formed with following objectives:-

1. Diffusing education in Goa through schools, colleges, Libraries, conferences etc. 2.Promoting by all means the spirit of brotherhood and harmony among youth.
3. Working for the upliftment of the moral , material and intellectual standards.

4. Undertaking propoganda of arts and crafts, and agricultural and industrial professions, through practical work in institutions.

### Working of committees

Both committees have their responsibilities laid down in the constitution. Some decisions are entirely with the general body and some are entirely with the working committees. for example:- Decisions regarding administration like appointment of teachers, discipline etc are taken by the working committee whereas if management wants to start a big project, working committee has to take prior permission of General Body. All financial issues are with General Body.

Meeting of committees :-General body meets three times during the year with all members of G.V.M. to discuss the various issues. These meetings are presided by the President with two secretaries. In case of absence of President, substitute President presides over the meeting. Issues discussed are minuted.

First meeting is held in the month of January to get the approval to the annual budget prepared by the working committee

Second meeting is held in the month of March to give approval to the annual report of the instruction.

Third meeting is held in the month of June, Audited statement of the previous year is discussed ( working committee has to prepare a comprehensive statement of all the financial details to be presented for the approval of General Body.

It is the privilege of the President, General Body to call extra – ordinary meeting of the General Body in case of any serious issues to be discussed

Procedure of Election to elect members of the committees:-

Every three years elections are held to elect the would be members on the two committees by the secret ballot. Each members has right to vote and elect five people in working committee and four people in General body.

Four members of General body consists of

1. President
2. President substitute

3. Two secretaries

Five members in working committee consists of

1. Chairman
2. Vice- Chairman
3. Secretary
4. Treasurer
5. A member

Tenure of General Body:- Is of three anybody from the General body aspiring to be can contest the election and become the member of the working committee.

Membership of the General body:- Is open to general public fulfilling the prescribed condition.

Qualification for teaching staff:-

- Primary level :-XII with D.Ed
- School level:-Graduate with B.Ed
- At Higher Secondary level:-Post graduation with B.Ed
- At College level- Post graduate with NET/ SET/ PHD
- B.Ed College:-Post graduation M.Ed with NET/ SET/ PHD
- M.ED College:-M.Ed with NET/ SET/ PHD.

### Different institutions of G.V.M. Primary schools

1. G.V.M's K.G. & Primary school, Ponda (Eng Med) Year of Est.- 1975.

Total staff-52

Total Strength of the students -1231 Teacher Student ratio- 1:25

2. G.V.M's K.G. & Primary School,Ponda (Mar Med) Year of Est.-1990

Total staff-08

Total strength of the students -320 Teacher Student ratio- 1:25

3. G.V.M's K.G. & Primary School, Khandepar(Eng Med) Year of Est.-2005

Total staff-06

Total Strength -622

Teacher student ratio- 1:25

4. G.V.M.'s K.G. & Primary School, Borim (Eng Med) Year of Est.-2004

Total staff-08

Total Strength -148

Teacher Student ratio-1:25

5. G.V.M.'s K.G. & Primary School, Bandora (Eng Med) Year of Est.-2005

Total staff -08

Total strength -224

Teacher Student ratio-1:25

6. G.V.M.'s K.G. & Primary School, Savoi Verem(Eng Med) Year of Est-2007

Total Staff-05 Total strength -155

Teacher Student ratio-1:25

7. G.V.M.'s K.G & Primary School, Savoi Verem(Mar Med) Year of Est.-2013

Total Staff-02 Total strength -064

Teacher Student ratio-1:25

### Secondary Schools

1. A.J.de Almeida High School, Ponda. Year of est.-1911

Total Staff-63

Total strength -2045

2. M.I.B.K.High School, Khandepar. Year of est.-1965

Total staff-36

Total strength – 1112

3. R.P.R.S High School, Bandora. Year of est. -1962

Total Staff-12 Total strength -269

4. Pragati Vidyalay Borim. Year of est.-1966

Total staff-10 Total strength -229

5. K.R.S.S.High School Savoi Verem. Year of est. -1964

Total Staff-10

Total strength – 261

6. Utkarsh Vidyamandir Year of est.- 2017 Total staff-10

Total Strength -291

### Higher Secondary School

1. G.V.M's SNJA Higher School, Farmagudi. Year of est.- 1975

Total Staff-35

Total strength -1029

2. G.V.M's Adarsh Higher Secondary Ponda. Year of est.- 2015

Total staff- 10 Total strength - 180

### Colleges

1. G.V.M'S G.G.Poy Raiturkar College of Commerce & Economics Farmagudi. Year of est.- 1975

Total Staff-B.Com-R-21/C-11

B C A-R-5/C-05

Total strength :-B.com- 650

M.com-24 B.CA-10

2. G.V.M's Dada Vaidya College of Education, Farmagudi. Year of est.-1993

Total Staff-B.Ed- 14

M.Ed-05

Total strength:- B.Ed-209

M.Ed-81

( For Higher Secondary, colleges Ratio of student teacher is appointed on the basis of strength of the students & not on the basis of ratio)

1. Resource rooms are also run by G.V.M.'s

2. Astronomical Observatory -Year of est-2005

### Qualification of teaching staff

Primary level :-XII with D.Ed

School level:-Graduate with B.Ed

At Higher Secondary level:-Post graduation with B.Ed



-At College level- Post graduate with NET/ SET/ PHD

B.Ed College:-Post graduation M.Ed with NET/ SET/ PHD

M.ED College:-M.Ed with NET/ SET/ PHD.

### G.V.M.'s quest for quality education

After liberation of Goa, Goa Vidyaprasarak Mandal opened four more schools in the different parts of Ponda Taluka. While these sister schools were growing into full fledged schools efforts were made in these schools to attain the standard set by A.J.de Almeida High School. Providing necessary infrastructure, appointing well qualified staff and impartial and standard evaluation were some of the steps taken to raise the performance level of the students.

For the purpose of evaluation all the five schools of the mandal came together and formed a board of examinations for the first terminal examination and the second terminal examination except for std v, vi and vii all other classes would have common paper. Papers were assigned to different teachers. After setting same would scrutinized by the competent teachers. Printed papers were dispatched to the different schools as per their requirements.

G.V.M.'s management implemented the idea of having subject forums few years ago. Each forum would have the convenor. There would be one chief convenor. All the subject teachers would be the member of respective forum. Here again papers are assigned

To teachers with the consent of the HMs. The scrutineers are appointed and they scrutinize the paper in the presence of the paper setters. Once the paper was checked they go for printing. Printed papers would go for to each schools as per the requirement. After the exam, the papers are discussed threadbare at the meeting of the subject forums, without any bias. This leads to quality paper setting, minimising the drawbacks and teachers are well-versed with the changing trends in paper setting.

Following areas are given importance and handled carefully by the management:-

1. Mental and physical health of the teachers and students :- Periodically assessed by health checkup

by conducting medical health camps.so also for the students.

2. Efforts made to uplift teacher's calibre:- Management holds motivational talks, seminars etc but the major limit is the time limit of the completion of school calendar.
3. Higher Education for the teachers:-We encourage teachers for aspiring Higher education by issuing no objection certificate,within the provision of the Mandal. As regard leave, scholarship , and fund is made applicable as per the guidelines of the government but no financial backing for the higher education from G.V.M's is given but in coming future we will definitely look into this matter.
4. Appreciation of the retired teachers :-Retired teachers are felicitated. Apporunity is given to those who are willing to tech in self financed schools of G.V.M's.or any other other activities of G.V.M.
5. Appreciation of the heads of the institutions:- Management acknowledge their efforts bby issuing letter of appreciation for doing better work and also by maintaining their good confidential work.
6. Appreciation of the student:- Students from different institutions are felicitated by giving trophies and scholarship to the students showing good academic performance such as highest marks in subjects,toppers, behaviour, all ,sports allrounder etc.
7. Appropriatness of the funds:-All the funds which G.V.M. receives from the Govt as grant for all graded schools has to be meticulously appropriated by the working committee after receiving the approval from the General body.

Whereas all the primary schools, Private schools, courses like M.Ed,pre- primary, teacher 's training are self financed. Colleges receive grant from Gov of India. UGC for the infrastructure development only.

8. Rules and regulations for the smooth functioning of the administration of the various institutions:- By issuing circulars and monitored by getting feedback from the heads of the institutions, conducting meeting of the staff and heads with the management.

9. Curriculum:- Different curriculum is followed according to the Goa board guidelines. Efforts are taken that inclusive education is imparted and spirit of brotherhood, belongingness is inculcated among students. Example:- Different festivals, Indigenous learning ,practical knowledge is given to the students so that they can prepare for real world situations.

10 Fee structure:-for self financed Schools of G.V.M's :- Tuition fees,Term fees Student Welfare funds are taken from students depending upon std and board.

(Parents are requested to pay the fees quarterly at the start of every quarter or the entire amount at one time.

11. Facilities in various institutions of G.V.M.:-All institutions of G.V.M. has basic facilities like School building, Library, Laboratory accept in Primary schools,Hall,Ground,Office,Staff room,H.M.Cabin, Washroom for students & Staff, Water facilities,

Computer room, Private canteen, Transport for added schools given by govt.

(Whereas resource rooms ,Smart classrooms, Music room,Art Gallery, Gymnasium, Theatre room, ramps and other facilities are available only in few schools

12. Role of P.T.A:-Parent teacher association plays an important role to work together towards a common goal in Education. P.T.A.of G.V.M.is very active. Majir role in P.T.A is of parents and teachers for the upliftment of the child.

P.T.A. secretary is one amongst the teacher who updates P.T.A of the school activity during the P.T.A meeting. During the meeting everyday issues are discussed. P.T.A also organises various curricular and extra – curricular activities in the schools. Such as from this health camps, mid day meal responsibility, felicitation for the students, competition are organised.

13. Difficulties face by the G.V.M's in handling administration:-

Managing administration is a challenging job. One is dealing with staff , Parents and govt official. Every day there are new ideas and every day there are problems, everyday there are challenges. Every day there are new approach. Problem has to be resolved. The management

has to be wise enough to take a decision as a result should be satisfactory and natural justice should be taken.

## CONCLUSION

Goa Vidyaprasarak Mandal has shaped the lives of thousands of students. It is like a power house which generates talent, skills, abilities of students. Basic facilities are provided in all the institutions of G.V.M. Efforts are going on to fulfils all the modern requirements in all the institutions Still lot of new projects will be brought by this management. Tackling many difficulties it is marching towards the success. Definitely it is focussing towards the sustainable education for the betterment of the Society.

## Tools used for data collection

- Questionnaire
- Documentation
- Checklist
- Interview
- Opinionnaire

## ACKNOWLEDGEMENT

I am thankful to Shri Bhaskar Khandeparkar, the President of Goa Vidyaprasarak Mandal and Shri Krishna Shetye,the chairman of Goa Vidyaprasarak Mandal for their support and motivation which I received from them while doing this research work.

## REFERENCES

1. Mandal, G. V. (2011). g v m p o n d a . com. Retrieved from <https://gvmponda.com/148-2/>: <https://gvmponda.com/institutions/>
2. UNESCO. (n.d.). e n . u n e s c o . o r g . Retrieved from <https://en.unesco.org/themes/education>: <https://en.unesco.org/themes/education/sdgs/material>
3. UNOOSA. (n.d.). United Nations - unoosa.org. Retrieved from [www.unoosa.org](http://www.unoosa.org): <https://www.unoosa.org/oosa/en/ourwork/space4sdgs/sdg4.html>
4. GVMs Vidyaprasarak Mandal, Ponda Goa <https://gvmponda.com/management/> <https://gvmponda.com/148-2/> <https://gvmponda.com/>

# A Project on Green Campus : Waste Water Management

**Amar D. Patil**

Dean Infrastructure

Dr. D. Y. Patil Pratishthans College of Engineering

Salokhenagar, Kolhapur, Maharashtra

✉ amar9205@gmail.com

**Rutikesh P. Gurav**

Head of First Year Engineering Department

Dr. D. Y. Patil Pratishthans College of Engineering

Salokhenagar, Kolhapur, Maharashtra

✉ gurav.rutikesh01@gmail.com

## ABSTRACT

The goal of wastewater management is to clean and protect water. This means that water must be clean enough so that it can be used by people for drinking and washing, and by industry for commercial purposes. It also must be clean enough to release into oceans, lakes, and rivers after it has been used. Our campus is situated at the Kalamba Ring Road, Kolhapur city over an area of 3.41 acres of land out of which 1.5 acres (6072.50 sq.m) area is covered by play ground. For our institute water demand for Lawn Watering to full fill demand (28800lit/day) we plan for Waste Water Management at DYP Salokhenagar.

The Main objectives of our project is to, reduces the water bill of our college, we used waste water for lawn watering, etc. We use waste water for lawn watering about 28800 liter per day. It results in saving the amount Rs.1032 per day. So we save Rs. 376680 per annum.

## INTRODUCTION

**W**astewater treatment is fundamental to protect the health of many different ecosystems. Wastewater, properly treated, is a source of water for many purposes. Good wastewater treatment allows the maximum amount of water to be reused instead of going to waste.

Wastewater is any water that has been contaminated by human use. Wastewater is used water from any combination of domestic, industrial, commercial or agricultural activities, surface runoff or storm water, and any sewer inflow or sewer infiltration. Therefore, wastewater is a byproduct of domestic, industrial, commercial or agricultural activities. The characteristics of wastewater vary depending on the source.

Wastewater is water whose physical, chemical or biological properties have been changed as a result of the introduction of certain substances which render it unsafe for some purposes such as drinking. The day to day activities of man is mainly water dependent and therefore discharge 'waste' into water. It is known that much of water supplied ends up as wastewater which makes its treatment very important. Wastewater treatment is the process and technology that is used

to remove most of the contaminants that are found in wastewater to ensure a sound environment and good public health. Wastewater Management therefore means handling wastewater to protect the environment to ensure public health, economic, social and political soundness. In the last decade, a number of studies, on wastewater reuse or optimal design of waste water treating systems have been presented. Though those studies have received much attention, they have been carried out exclusively on wastewater treating system without paying attention to water using system. The connection between wastewater and overall sustainability is far simpler to grasp in a small constructed mini-world. There it is clear that the production of "wastewater" by human activities – from crop-production, raising of livestock, laboratories and workshops, kitchens, showers, laundries and toilets – must be recycled safely back into the overall water cycle. In a materially-closed system, there is only a finite quantity of materials.

## CHARACTERISTICS OF WASTEWATER

The three main characteristics of wastewater are classified below.

1. Physical Characteristics

- Turbidity
  - Color
  - Odor
  - Total solids
  - Temperature
2. Chemical Characteristics due to Chemical Impurities
- Chemical Oxygen Demand (COD)
  - Total Organic Carbon (TOC)
  - Nitrogen
  - Phosphorus
  - Chlorides
  - Sulfates
  - Alkalinity
  - pH
  - Heavy Metals
  - Trace Elements
  - Priority Pollutants
3. Biological Characteristics due to Contaminants
- Biochemical Oxygen Demand (BOD)
  - Oxygen required for nitrification
  - Microbial population

**ABOUT WASTE WATER MANAGEMENT**

**Objectives**

The campus of this institute is situated at the Kalamba Ring Road, Kolhapur city over an area of 3.41 acres of land. The institute area is at the center of the campus and surrounded by the residential areas. There are five departments, total strength of campus including students and staffs will be more than 700.

Thus, with this present strength and also with the expansion programmes, campus should also increase its facilities and maintenance requirements.

Thus water is the most natural resource which is being always in high demands and is indispensable part of the

life. For institute water demand for Lawn Watering to full fill demand (28800lit/day) we plan for Waste Water Management at DYP Salokhenagar.

**Main objectives of waste water are as follows**

1. To meet the rising demand of water needs.
2. Away to minimize waste.
3. It can reduce the water bill.
4. It can be used for lawn watering.
5. It is an excellent source of water for landscaping.

As discussed earlier in the section of introduction – importance of waste water management at DYP Salokhenagar. We clearly came to know all the advantages which we can draw out by implementing this small but highly efficient technique in the campus. Thus to increase the potential, benefits of this system and draw maximum advantages from it, we need to have install instruments such as pumping system, waste water treatment plant, sprinkler gun.

**Table 1: Technical Specifications & Parameters of Pump (LADA LAXMI PUMP)**

Model	10AH65HH CD.LV
Size	65 X 50 mm
KW/HP	7.5/10
Volt	415
Hz	50
A	20
Class	B
RPM	2930
Head	61M
Discharge	480 LPM

**Table 1: Field Specifications & Analysis**

Sr. No	Particular	Details
1	Pump installation date	1 October 2019
2	Pumping capacity of pump per minute (Discharge):	480 LPM
3	Water used for lawn watering per day (480lit x 60 min)	28800 lit

4	Cost of water for colleges as per municipal corporation	Rs. 40/1000 lit
5	Cost saved from lawn watering per day(288 x 4)	Rs. 1152
6	Deduction for approx. electricity consumption per hour ( 8 units x Rs.15 )	Rs. 120
7	Amount saved per day	Rs. 1032
8.	Amount saved per year using waste water(Rs.1032 x 365)	Rs. 376680
8	Initial cost of pump including installation & plumbing	Rs. 250000
9	No. of days required to nullify initial investment( 250000/1032)	242 days
10	Cost of Sprinkler Gun	Rs. 35000
11	System runs in profit from date	3 June 2020



Fig. 1: Waste Water Lifting Pump arrangements



Fig. 2: Lawn Watering



Fig. 3: Lawn Watering

**BENEFITS**

**College**

- Helps in reducing the water bills
- Saving water
- Reduce the need of imported water
- Decreases the demand of water
- This technology is easy to install and operate

**Students**

- Addition in technical knowledge
- Awareness regarding waste water management
- Scope in research waste water project
- Scope in making government policies regarding waste water management.

**Nation**

- Beneficial to environment.
- A way to minimize waste.
- Less water pollution.
- It is an excellent source of water for landscaping.

**CONCLUSION**

Significance of wastewater gardens for developing countries

- The system is most suited in tropical areas where plant growth is all year round



- The availability of cheap labour and less operating cost
  - The aesthetic approach to waste and wastewater is advantageous for such a project
  - Most places lack drainage or proper wastewater collection and treatment options
  - Solution to health problems related to disposal of wastewater
  - Can be a community project
  - Help in greening the community and increasing biodiversity
  - Facility can be used for growing plants needed for the community
  - System can be designed for individual houses to a cluster scale housing to a community scale.
3. Nelson, M. & Tredwell, R. 2002 Wastewater Gardens: Creating urban oases and greenbelts by productive use of the nutrients and water in domestic sewage, paper for Cities as Sustainable Ecosystems (CASE) Conference, April 2002 Murdoch University, Perth, Australia
  4. Oyama, N., Nair, J. & Ho, G. E. 2005 Recycling of treated domestic effluent from an on-site wastewater treatment system for hydroponics. *Water Sci. Technol.* 51(10), 220–221.
  5. Tredwell, R. & Nelson, M. 2006 Effective approaches for environmental and wastewater management and training- the Birdwood Downs case studies in the Kimberley region of West Australia, Conference on the Sustainability of Indigenous Communities July 2006 Murdoch University, Western Australia.
  6. Hanjra MA, Blackwell J, Carr G, Zhang F, Jackson TM (2012) wastewater irrigation and environmental health: implications for water governance and public policy. *International Journal of Hygiene and Environmental Health* 215, 255-269.
  7. Massoud MA, Tarhini A, Nasr JA (2009) Decentralized approaches to wastewater treatment and management: Applicability in developing countries. *Journal of Environmental Management* 90, 652-659.
  8. Oliveira SC, von Sperling M (2011) Performance evaluation of different wastewater treatment technologies operating in a developing country. *Journal of Water, Sanitation and Hygiene for Development* 1, 37-56.

## REFERENCE

1. Al Salem, S. S. 1996 Environmental considerations for wastewater reuse in agriculture. *Water Sci. Technol.* 33(10–11), 345–353.
2. Asano, T. & Levine, A. D. 1996 Wastewater reclamation, recycling and reuse: past, present, and future. *Water Sci. Technol.* 33(10–11), 1–14.

# Achieving Social Inclusion in India: A Conceptual Framework towards Sustainable Development Goals (SDGs)

**Avinash Bhale**

Assit. Professor cum Assit. Director  
Centre for Study of Social Exclusion and Inclusive  
Policy, Shivaji University  
Kolhapur, Maharashtra  
✉ avinash.bhale@gmail.com

**Jayanand S. Khandagale**

Amity University  
Mumbai, Maharashtra  
✉ drjayanandkhandagale@gmail.com

## ABSTRACT

This conceptual research paper explores the intersection of Sustainable Development Goals (SDGs) and social inclusion in the context of India. It aims to provide a comprehensive framework for understanding the challenges, opportunities, and strategies for promoting social inclusion as a means to achieve the SDGs. The paper synthesizes existing literature, theoretical perspectives, and empirical evidence to develop a conceptual framework that integrates various dimensions of social inclusion, including gender equality, poverty alleviation, education, healthcare, and inclusive economic growth. By highlighting the interlinkages between social inclusion and sustainable development, this paper seeks to inform policymakers, researchers, and practitioners about the importance of adopting a holistic approach to development that prioritizes equity, diversity, and inclusion.

**KEYWORDS** : *Social inclusion, Sustainable Development Goals (SDGs), India, Gender equality, Poverty alleviation, Education, Healthcare, Economic growth.*

## INTRODUCTION

India, as one of the world's fastest-growing economies, has made significant strides towards achieving several Sustainable Development Goals (SDGs). However, despite economic progress, the country continues to grapple with pervasive social inequalities and exclusionary practices that marginalize certain segments of the population. Social inclusion, defined as the process of ensuring that all individuals and groups have equal opportunities to participate in and benefit from development initiatives, is fundamental to achieving sustainable and equitable development. In this paper, we explore the nexus between SDGs and social inclusion in the Indian context, aiming to provide a conceptual framework that elucidates the complexities of this relationship and offers insights into effective strategies for promoting social inclusion to realize the SDGs.

## THEORETICAL FRAMEWORK

The conceptual framework guiding this research

draws upon theories of social inclusion, human development, and sustainable development. Sen's capability approach provides a foundational lens through which to analyze the multidimensional nature of social exclusion and to conceptualize development as the expansion of individuals' capabilities to lead lives they value. Additionally, Amartya Sen's emphasis on the importance of freedom, agency, and participation resonates with the principles of social inclusion, which prioritize the removal of barriers that impede individuals' ability to fully participate in society (Sen, 2000). Furthermore, the integration of SDGs into the framework underscores the interconnectedness of social, economic, and environmental dimensions of development, emphasizing the need for inclusive and sustainable approaches to address the root causes of poverty, inequality, and marginalization. The theoretical framework for understanding social inclusion in the context of India and its alignment with the Sustainable Development Goals (SDGs) involves several key elements:

There is need to understand the Social Exclusion in Indian context:

For proper social inclusion there is need to develop, underrating related social exclusion. In Indian context, Social exclusion and intersectionality are critical concepts that shape the dynamics of inclusion and equality in societies, particularly in a diverse and complex context like India.

### **Caste-Based Social Exclusion**

The caste system has been a defining feature of Indian society for centuries, dividing people into hierarchical groups based on birth. Dalits, formerly known as "untouchables," face severe discrimination and social exclusion due to their caste status. The National Crime Records Bureau's 'Crime in India' report 2022 report brings into focus the vulnerability of Scheduled Castes and Scheduled Tribes. With 57,582 cases registered for committing crime against Scheduled Castes (SCs) in 2022, the data reflects an increase of 13.1% over 2021 (50,900 cases). The highest number of cases (18,428) accounting for 32% of the total cases were registered under simple hurt followed by cases under criminal intimidation with 9.2% (5,274 cases) and SC/ST (Prevention of Atrocities) Act with 8.2% (4,703 cases). (NCRB, 2022).

Despite legal measures and affirmative action policies, caste-based discrimination persists in various forms, including access to education, employment, and public services. Dalits continue to face social stigma and violence, limiting their opportunities for social mobility.

### **Gender-Based Social Exclusion**

India has a patriarchal society where gender roles and norms dictate women's subordinate position in the family and society. Women face discrimination and exclusion in areas such as education, employment, property rights, and participation in decision-making processes. Women from marginalized castes and lower socio-economic backgrounds experience intersecting forms of discrimination, exacerbating their vulnerability to social exclusion. This intersectionality amplifies barriers to empowerment and access to resources. The data disclosed a staggering 4, 45,256 cases of crime against women in 2022, translating to approximately 51 FIRs every hour. This marked a notable increase from

2021, which recorded 4, 28,278 cases, and 2020, which reported 3, 71,503 cases. The NCRB's findings unveiled a crime rate of 66.4 per lakh population, with a charge-sheeting rate of 75.8 in such cases. (NCRB, 2022)

### **Class-Based Social Exclusion**

India has significant income inequality, with a large proportion of the population living in poverty or struggling to access necessities. Those from lower socio-economic classes often face exclusion from quality education, healthcare, and formal employment opportunities. Economic policies have primarily focused on urban areas. These relied on the philosophy that the benefits of India's high growth and expansion of industrial urban centers would automatically percolate down to the rural area. This has led to the unequal growth of rural areas and has resulted in a sense of deprivation and dissatisfaction amongst a large percentage of rural population. Hence, a majority of rural society remains excluded from India's journey of development. About 70% of the population lives in rural area and about 50% of the overall labour force is still dependent on agriculture that is not productive enough. The GDP contribution of agriculture to the nation is only about 14% while for industries and services sector (employers of people living in urban areas), it is 26% and 60% respectively. India has an insufficient public healthcare infrastructure. A majority of health infrastructure is in the private sector, which is limited to the middle classes in urban India. Rural areas are catered by government-run dispensaries that lack infrastructure and medicines.

Rural populations, particularly agricultural laborers and marginalized communities, endure the most of socio-economic exclusion. Lack of infrastructure, inadequate social services, and limited employment options perpetuate cycles of poverty and marginalization. (Review, 2020)

Social exclusion in India is deeply rooted in caste, gender, and class inequalities, perpetuating systemic injustice and hindering inclusive development. Addressing these intersecting forms of discrimination requires concerted efforts from government, civil society, and communities to create a more equitable and inclusive society where every individual has the opportunity to thrive, regardless of their background or identity.

## INTERSECTIONALITY: A FRAMEWORK FOR ANALYSIS IN INDIAN CONTEXT

Intersectionality emphasizes the interconnected nature of social identities and power structures. It recognizes that individuals experience oppression and privilege along multiple axes, which intersect to shape their lived experiences (Mrudula Anne, 2013).

Recognizing the intersectionality of identities and forms of discrimination is crucial for understanding social inclusion in India. In India, the complexities of social exclusion are deeply intertwined with the intersecting factors of gender, caste, and class. This essay explores the nuanced interactions between these dimensions of identity, highlighting how they shape experiences of marginalization and perpetuate inequalities within society. In the Indian context, the intersectionality lens reveals the compounding effects of gender, caste, and class on individuals' access to resources, opportunities, and social recognition.

### Gender and Caste: Double Marginalization of Women

Indian society is deeply patriarchal, with rigid gender roles that assign women subordinate status in relation to men. This intersects with caste dynamics to exacerbate the marginalization of women from lower castes. Dalit women, in particular, face the dual burden of caste-based discrimination and gender-based oppression (Kumar, October 2, 2010 ). They are often excluded from both public and private spheres, facing violence, exploitation, and limited opportunities for education and employment.

### Caste and Class: Economic Disparities and Social Exclusion

Caste intersects with class to perpetuate economic disparities, with marginalized castes disproportionately represented among the poorest sections of society. Discrimination in access to land, resources, and livelihood opportunities further marginalizes these communities. The intersection of caste and class is starkly evident in the urban-rural divide, where marginalized castes often face exclusion from urban development and formal employment sectors, relegating them to the margins of society (Retu, 2021).

### Class and Gender: Intersectional Vulnerabilities of Poor Women

Women from lower socio-economic backgrounds face intersecting forms of marginalization due to their gender and class identities. They are often trapped in cycles of poverty, lacking access to education, healthcare, and economic opportunities. Economic policies and development interventions may exacerbate gender disparities, particularly for women from marginalized communities who withstand the worst of structural inequalities in access to resources and decision-making power. (Kumar, October 2, 2010 )

Intersectionality provides a powerful framework for understanding the complex and intersecting dynamics of social exclusion in India. Addressing these intersecting inequalities requires holistic approaches that recognize the interconnectedness of gender, caste, and class, and the need for targeted interventions to uplift marginalized communities. By adopting intersectional perspectives in policy formulation, advocacy, and social activism, India can move closer to realizing its vision of a more equitable and inclusive society, where every individual, regardless of their identity, has the opportunity to thrive.

## UNDERSTANDING SOCIAL INCLUSION IN INDIAN CONTEXT

Social inclusion may refer to a process encouraging social interaction between people with different socially relevant attributes or an impersonal institutional mechanism of opening up access to participation in all spheres of social life. (Silver, 2015 ) In India, social inclusion is a critical issue due to the country's diverse population, complex social hierarchies, and historical discrimination against certain groups. Marginalized communities in India face barriers to education, healthcare, employment, and political participation, which perpetuate cycles of poverty and exclusion. Social inclusion refers to the process of ensuring that all individuals and groups in society have equal opportunities to participate in social, economic, and political activities, regardless of their background or identity. This includes marginalized groups such as women, minorities, persons with disabilities, and indigenous communities.

## SUSTAINABLE DEVELOPMENT GOAL AND INCLUSION DISCOURSE

The Sustainable Development Goals (SDGs) and inclusion discourse are closely intertwined, as the SDGs aim to promote sustainable development that leaves no one behind, with a focus on inclusivity and equity. Inclusion discourse refers to the ongoing conversations, analyses, and actions aimed at ensuring that all individuals, regardless of their background or identity, have equal access to opportunities, resources, and rights within society.

Several SDGs directly address inclusion and equity concerns. Example Goal 1: No Poverty: Targets the eradication of extreme poverty and aims to ensure social protection for the poor and vulnerable. Goal 4: Quality Education: Aims to ensure inclusive and equitable quality education and promote lifelong learning opportunities for all, with a focus on bridging disparities in access to education. Goal 5: Gender Equality\*\*: Seeks to achieve gender equality and empower all women and girls, addressing the structural barriers that prevent equal participation and opportunities. Goal 10: Reduced Inequalities: Targets the reduction of inequalities within and among countries by empowering and promoting the social, economic, and political inclusion of all individuals, regardless of their background. Goal 16: Peace, Justice, and Strong Institutions: Aims to promote peaceful and inclusive societies for sustainable development, ensuring access to justice for all and building inclusive institutions at all levels.

These goals reflect a commitment to addressing inclusion disparities based on factors such as gender, race, ethnicity, disability, and socioeconomic status. Inclusion discourse around the SDGs involves examining policies, practices, and interventions to ensure that they are inclusive and equitable, identifying barriers to inclusion, and advocating for measures that promote equal opportunities and participation for all members of society.

## STRATEGIES FOR PROMOTING SOCIAL INCLUSION IN INDIAN CONTEXT

Promoting social inclusion in the Indian context

requires tailored strategies that address the country's unique social, cultural, and economic challenges. Here are some strategies for promoting social inclusion in India:

1. **Education Reform:** Implement policies and programs to ensure universal access to quality education, especially for marginalized communities such as Dalits, Adivasi's, and religious minorities. This includes improving infrastructure in rural areas, providing scholarships and incentives for underprivileged students, and promoting inclusive curricula that reflect diverse cultural perspectives.
2. **Empowerment of Women and Girls:** Focus on empowering women and girls through initiatives such as girls' education programs, skill development training, and access to healthcare services. Promote gender-sensitive laws and policies that address issues such as violence against women, gender-based discrimination, and economic empowerment.
3. **Affirmative Action:** Strengthen affirmative action measures such as reservations in education, employment, and political representation for historically marginalized groups, including Scheduled Castes (SCs), Scheduled Tribes (STs), and Other Backward Classes (OBCs). Ensure effective implementation and monitoring of these policies to promote social inclusion and reduce caste-based discrimination.
4. **Rural Development:** Invest in rural development initiatives aimed at reducing poverty, improving access to basic services such as clean water, sanitation, and healthcare, and promoting sustainable livelihoods. Empower local communities, particularly marginalized groups in rural areas, through capacity-building programs, decentralized governance structures, and inclusive development planning processes.
5. **Skill Development and Employment:** Promote skill development programs and vocational training initiatives to enhance the employability of marginalized youth and facilitate their integration into the formal economy. Encourage private sector engagement in creating job opportunities for disadvantaged groups, including persons with



disabilities, through inclusive hiring practices and corporate social responsibility initiatives.

6. **Social Protection:** Strengthen social protection schemes such as the National Rural Employment Guarantee Act (NREGA), the Public Distribution System (PDS), and the National Social Assistance Program (NSAP) to provide income support, food security, and social security to vulnerable populations. Expand the coverage and effectiveness of these schemes to reach those who are most in need.
7. **Community Mobilization and Awareness:** Promote community mobilization and awareness-raising campaigns to challenge social norms, stereotypes, and prejudices that perpetuate exclusion and discrimination. Foster dialogue and collaboration among diverse communities to build social cohesion and solidarity across caste, religion, ethnicity, and gender lines.
8. **Digital Inclusion:** Bridge the digital divide by expanding access to digital technologies and internet connectivity, particularly in rural and remote areas. Promote digital literacy programs and e-governance initiatives that empower marginalized communities to access information, services, and opportunities online.

By implementing these strategies in a comprehensive and integrated manner, India can make significant progress towards promoting social inclusion and building a more equitable and inclusive society for all its citizens.

### **SUSTAINABLE DEVELOPMENT GOALS (SDGs) REQUIRES A MULTIFACETED APPROACH**

Promoting social inclusion through the Sustainable Development Goals (SDGs) requires a multifaceted approach that addresses the various dimensions of exclusion. Here are some strategies for promoting social inclusion through the SDGs:

1. **Education for All (SDG 4):** Ensure access to quality education for all individuals, including marginalized and vulnerable groups such as girls, children with disabilities, and those living in remote or

underserved areas. Implement inclusive education policies and practices that accommodate diverse learning needs and foster a sense of belonging for all students.

2. **Gender Equality (SDG 5):** Promote gender equality by addressing discriminatory norms and practices that limit women's and girls' opportunities and participation in social, economic, and political life. Implement policies and programs that empower women and girls, ensure equal access to education and healthcare, and promote women's leadership and decision-making roles.
3. **Reducing Inequalities (SDG 10):** Target efforts to reduce inequalities within and among countries by addressing disparities in income, wealth, and access to resources and opportunities. Implement progressive taxation policies, social protection programs, and affirmative action measures to level the playing field and ensure that no one is left behind.
4. **Building Inclusive Communities (SDG 11):** Create inclusive, safe, and resilient cities and communities that provide equal opportunities and access to services for all residents, including marginalized and vulnerable populations. Invest in accessible infrastructure, affordable housing, public transportation, and green spaces that enhance quality of life and social cohesion.
5. **Promoting Peaceful and Inclusive Societies (SDG 16):** Foster social cohesion, tolerance, and respect for diversity by promoting dialogue, reconciliation, and the rule of law. Strengthen institutions that uphold human rights, promote access to justice for all, and ensure accountability and transparency in governance.
6. **Partnerships for Inclusion (SDG 17):** Foster collaboration and partnerships among governments, civil society, the private sector, and international organizations to address the root causes of exclusion and promote inclusive development. Engage with marginalized and vulnerable communities as active partners in decision-making processes and development initiatives.

By integrating these approaches into national policies, programs, and development agendas, countries can advance social inclusion and progress towards achieving the Sustainable Development Goals for a more equitable and sustainable future.

## CONCLUSION

Achieving the SDGs in India necessitates a concerted effort to promote social inclusion across all spheres of development. By adopting a holistic and rights-based approach, that addresses the structural determinants of exclusion and inequality, India can realize its vision of inclusive and sustainable development. This conceptual framework provides a roadmap for policymakers, practitioners, and researchers to navigate the complexities of promoting social inclusion and advancing the SDGs agenda in India.

## REFERENCES

1. Kumar, A. (October 2, 2010). Understanding Lohia's Political Sociology: Intersectionality of Caste, Class, Gender and Language. *Economic & Political Weekly*, 64-70.
2. Mrudula Anne, J. C. (2013). Gender and caste intersectionality in the Indian context. *Human Resource Management, IPISS*.
3. NCRB. (2022). 'Crime in India' report 2022. The National Crime Records Bureau's.
4. Retu. (2021). Understanding Intersectionality with Special Reference to Scheduled Caste Girls at Secondary. NEW DELHI: NATIONAL UNIVERSITY OF EDUCATIONAL PLANNING AND ADMINISTRATION, NEW DELHI.
5. Review, C. S. (2020, Dec 19). <https://www.competitionreview.in/> CO. Retrieved from <https://www.competitionreview.in/blogs/2020/12/19/urban-rural-divide/>: <https://www.competitionreview.in/blogs/2020/12/19/urban-rural-divide/>
6. Sen, A. (2000). *SOCIAL EXCLUSION: CONCEPT, APPLICATION, AND SCRUTINY*. Manila, Philippines: Asian Development Bank.
7. Silver, H. (2015). *The Contexts of Social Inclusion*. UNITED NATION.

# Assessing Progress towards Sustainable Development Goals with Reference to India: A Comprehensive Analysis of the UN's 2030 Agenda

Vitthal Thabbe

✉ vtt.rs.economics@unishivaji.ac.in

Vidyanand Khandagale

✉ vidyanandkhandagale@gmail.com

## ABSTRACT

The study aims to comprehensively evaluate the progress made towards the United Nations Sustainable Development Goals (SDGs) as outlined in the 2030 Agenda. Using a secondary source of data, the research will explore existing progress reports to assess the achievements, challenges, and disparities associated with each SDG. The investigation seeks to provide valuable insights into the global efforts toward sustainable development, identify areas of success, and pinpoint challenges that require increased attention in Indian context.

The research outline incorporates a systematic approach, utilizing diverse indicators and metrics to create a nuanced understanding of the current status of the SDGs with reference to India. By analyzing existing reports, the study aims to contribute to the ongoing discourse on sustainable development and provide a foundation for future interventions and policy considerations.

This study evaluates India's progress towards achieving the Sustainable Development Goals (SDGs) across different states and union territories. The data reveals an average national growth rate of 15.8% over three years, indicating concerted efforts towards advancement. However, the varying rates of progress among states highlight the heterogeneity of developmental challenges and successes across the country. While some states have made notable strides in areas like employment generation and digital inclusion, others face significant hurdles in sectors such as health, education, gender equality, and environmental conservation. The analysis underscores the need for targeted interventions, policy reforms, and knowledge-sharing to address specific developmental gaps. Additionally, the absence of any state or union territory in the "Achiever" category suggests room for improvement even among the best-performing regions. Consistent and focused efforts are essential to sustain momentum, bridge existing gaps, and ensure equitable development across all regions of India.

## INTRODUCTION

The United Nations Sustainable Development Goals (SDGs), outlined in the 2030 Agenda, represent a global commitment to addressing pressing social, economic, and environmental challenges. As the deadline for achieving these goals approaches, there is a growing need to assess the progress made and identify areas requiring further attention. This study aims to comprehensively evaluate progress towards the SDGs,

providing valuable insights into the global efforts towards sustainable development.

## NEED AND SIGNIFICANCE

The need for this research arises from the urgency to track and evaluate the implementation of the SDGs to ensure that no one is left behind in the pursuit of sustainable development. By assessing progress towards the SDGs, we can identify areas of success and gaps

that need to be addressed. This research is significant as it provides a comprehensive analysis of the efforts made towards achieving the SDGs, informing policymakers, practitioners, and stakeholders about the effectiveness of current strategies and interventions.

Understanding the progress towards the SDGs is essential for guiding future actions and investments, ensuring that resources are allocated efficiently and effectively. Additionally, this research contributes to the broader discourse on sustainable development, fostering dialogue and collaboration among various stakeholders to accelerate progress towards the SDGs.

### Objectives of the Study

- The primary objectives of this research are as follows:
- To comprehensively evaluate the progress made towards each of the United Nations Sustainable Development Goals (SDGs) as outlined in the 2030 Agenda.
- To measure the status of Indian state and Union territory with reference to the Indicators of SDG's.

- To measure the status of Indian state and Union territory with reference to the goals of SDG's.

### RESEARCH DESIGN

This research will adopt a systematic approach, utilizing secondary sources of data such as progress reports, official statistics, and academic literature. The study will employ qualitative and quantitative analysis methods to assess progress towards the SDGs comprehensively.

Data collection will involve reviewing and synthesizing existing progress reports and data sources from relevant international organizations, government agencies, and research institutions. The analysis will focus on identifying trends, patterns, and disparities in the achievement of each SDG, considering factors such as geographic location, income level, and demographic characteristics.

Furthermore, the research will employ diverse indicators and metrics to evaluate progress towards the SDGs, ensuring a comprehensive understanding of the multifaceted nature of sustainable development in reference to Indian Context.

### DATA ANALYSIS

**Table 1: Indian States' SDG Scores Analysis: Trends and Growth (2018-2020)**

State	SCORE in 2018	SCORE in 2019	Difference (2018-2019)	SCORE in 2020	Difference (2019-2020)	Growth Rate Between 3 years
Andhra Pradesh	64	67	3	72	5	12.5
Arunachal Pradesh	51	53	2	60	7	17.6
Assam	49	55	6	57	2	16.3
Bihar	48	50	2	52	2	8.3
Chhattisgarh	58	56	-2	61	5	5.2
Goa	64	65	1	72	7	12.5
Gujarat	64	64	0	69	5	7.8
Haryana	55	57	2	67	10	21.8
Himachal Pradesh	69	69	0	74	5	7.2
Jharkhand	50	53	3	56	3	12.0
Karnataka	64	66	2	72	6	12.5
Kerala	69	70	1	75	5	8.7

Madhya Pradesh	52	58	6	62	4	19.2
Maharashtra	64	64	0	70	6	9.4
Manipur	59	60	1	64	4	8.5
Meghalaya	52	54	2	60	6	15.4
Mizoram	59	56	-3	68	12	15.3
Nagaland	51	57	6	61	4	19.6
Odisha	51	58	7	61	3	19.6
Punjab	60	62	2	68	6	13.3
Rajasthan	59	57	-2	60	3	1.7
Sikkim	58	65	7	71	6	22.4
Tamil Nadu	66	67	1	74	7	12.1
Telangana	61	67	6	69	2	13.1
Tripura	55	58	3	65	7	18.2
Uttarakhand	60	64	4	72	8	20.0
Uttar Pradesh	42	55	13	60	5	42.9
West Bengal	56	60	4	62	2	10.7
India	57	60	3	66	6	15.8

Source: NITI Ayog

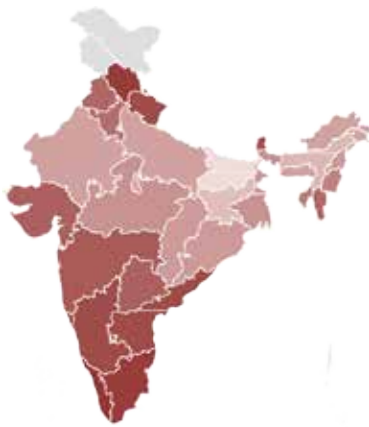

Fig. No 1: SDG Performance Scores of Indian States (2020)

### OBSERVATIONS AND ANALYSIS OF STATE SCORES

1. The states like Uttarakhand, Andhra Pradesh and Sikkim are falls under the high SDG score states in 2020 and these states are speedily marching towards attaining targeted SDG. Although Maharashtra, Himachal Pradesh and Kerala are recorded very insignificant growth rate, these state were leading

in SDG score 2020. The states such as Tamil Nadu, Karnataka, Goa and Telangana are also falls under top ten group of the states as per the SDG score 2020 with moderate growth rate.

2. Although the states like Telangana, Andhra Pradesh, Karnataka, Goa, Tamil Nadu are growing smoothly and gradually, these states are hold their position in top ten in the achievement of targeted SDG 2020. The situation of the Mizoram and Punjab is quite identical both the states are having moderate growth rate and they hold middle state position in targeted SDG score ranking 2020. The condition of the Meghalaya state is dismal in terms of achievement of targeted SDG score 2020, however it has recorded moderate growth rate.
3. It is interesting to note that the Maharashtra and Kerala states are hold their position in top ten state in the achievement of targeted SDG score 2020 with low growth rate. It means that although the speed of attaining SDG target is low, these two states are achieved significant progress in SDG target. Somehow identical condition of the states is found in which these states are not only lagging behind in terms of attaining SDG targeted score



but also fail in attaining significant growth rate. These identical most alarming states are namely Jharkhand, West Bengal, Manipur, Bihar, Gujarat, Himachal Pradesh, Chhattisgarh and Rajasthan.

The table presents a comprehensive view of the progress made by Indian states in achieving Sustainable Development Goals (SDGs) over three years, from

2018 to 2020. A positive trend is observed across most states, with incremental improvements in their scores each year. Notably, Uttar Pradesh exhibits the highest growth rate at 42.9%, indicating significant strides in development efforts. On the other hand, states like Chhattisgarh and Rajasthan show minimal growth or even a decrease in scores from 2018 to 2019, suggesting areas of concern that require attention.

**Table 2: Indian Union Territory SDG Scores Analysis: Trends and Growth (2018-2020)**

Union Territory	SCORE 2018	SCORE 2019	Difference (2018-2019)	SCORE 2020	Difference (2019-2020)	Growth Rate Between 3 years
Andaman and Nicobar Islands	58	61	3	67	6	15.5
Chandigarh	68	70	2	79	9	16.2
Dadra and Nagar Haveli	57	63	6	62	-1	8.8
Daman and Diu	63	61	-2	62	1	-1.6
Delhi	62	61	-1	68	7	9.7
Jammu & Kashmir and Ladakh	53	59	6	66	7	24.5
Lakshadweep	62	63	1	68	5	9.7
Puducherry	65	66	1	68	2	4.6

Source: NITI Ayog

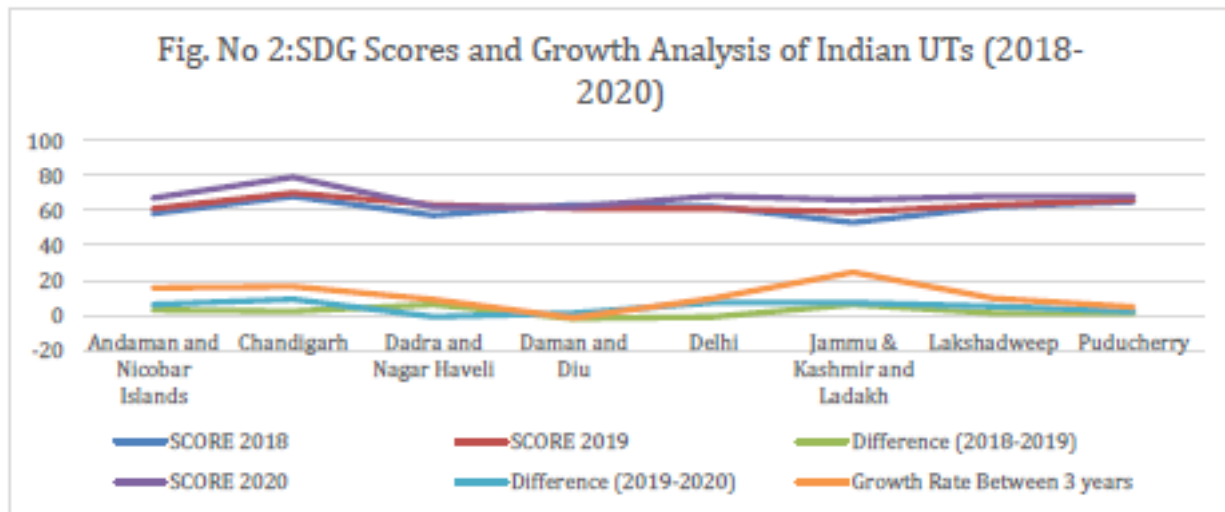

**Fig. 2: SDG Scores and Growth Analysis of Indian UTs (2018-2020)**

Table 3: SDG Goal Performance: Target Areas and Achievements in India (2020)

Goal Name	Area	Target	India
No Poverty	Persons provided employment as a percentage of persons who demanded employment under Mahatma Gandhi National Rural Employment Guarantee Act (MGNREGA)	84.75	84.75
	Proportion of the population (out of total eligible population) receiving social protection benefits under Maternity Benefit	100	36.4
	Percentage of households with any usual member covered by a health scheme or health insurance	100	28.7
	Percentage of population living below the national poverty line	10.95	21.92
	Number of homeless households	0	10.39
Zero Hunger	Rice wheat and coarse cereals produced annually per unit area	5018.44	2509.22
	Percentage of pregnant women aged 15-49 years who are anaemic	23.57	50.3
	Percentage of children under five years who are stunted	21.03	38.4
	Ratio of rural households covered under public distribution system to rural households where monthly income of highest earning member is less than Rs.5000	1.29	1.01
Good Health and Well-being	Children aged 12-23 months fully immunized (BCG Measles and three doses of Pentavalent vaccine)	100	62
	Number of governmental physicians nurses and midwives	549.96	220.96
	Total case notification rate of tuberculosis	0	138.33
	Maternal mortality ratio	70	130
	Women in the age group of 15-49 years using modern methods of family planning	100	53.5
	Under 5 mortality rate	11	50
Quality Education	Correct responses on Learning Outcomes in Language Mathematics	57.17	44.58
	Adjusted Net Enrolment Elementary (Class 1-8) and (Class 9-10) education	100	81.15
	Average annual dropout rate at secondary level (class 9-10)	100	75.83
	Correct responses on Learning Outcomes in Language Mathematics and EVS for Class 5 students	100	70.43
	Science and Social Science for Class 8 students	67.89	54.69
	Elementary and secondary schools with Pupil Teacher Ratio less than/equal to 30	10	17.06
	School teachers professionally qualified	0.28	2.97
Gender Equality	Sex ratio at birth	954	898
	Married women aged 15-49 who have ever experienced spousal violence	0	33.3
	Percentage of elected women over total seats in the state legislative assembly	50	8.7
	Average female to male ratio of average wages/salaries received per day by regular wage/salaried employees of age 15-59 for rural and urban	1	0.7

	Ratio of female to male Labour Force Participation Rate (LFPR) (15-59 years)	1	0.64
	Ratio of Female Labour force participation rate to Male Labour force participation rate	1	0.32
Clean Water Sanitation	Sex ratio at birth	954	898
	Married women aged 15-49 who have ever experienced spousal violence	0	33.3
	Percentage of elected women over total seats in the state legislative assembly	50	8.7
	Average female to male ratio of average wages/salaries received per day by regular wage/salaried employees of age 15-59 for rural and urban	1	0.7
	Ratio of female to male Labour Force Participation Rate (LFPR) (15-59 years)	1	0.64
	Ratio of Female Labour force participation rate to Male Labour force participation rate	1	0.32
Clean Water Sanitation	Rural households with individual household toilets	100	82.72
	Population having safe and adequate drinking water in rural areas	100	71.8
	Percentage of districts verified to be ODF (SBM(G))	100	31.95
Affordable and Clean Energy	Percentage of households electrified	100	94.57
	Households using Clean Cooking Fuel	100	43.8
Decent Work and Economic Growth	Households with a bank account	100	99.99
	Average unemployment rate per 1000 persons for males and females	14.83	63.5
	Automated Teller Machines (ATMs)	50.95	16.84
	Annual growth rate of GDP (constant prices) per capita	10	6.5
Industry, Innovation and Infrastructure	Number of mobile connections (mobile tele density)	82.97	100
	Percentage of targeted habitations connected by all-weather roads under Pradhan Mantri Gram Sadak Yojana (PMGSY)	100	47.38
	Gram Panchayats covered under Bharat Net	100	42.43
	Number of internet subscribers	100	33.47
Reduced Inequality	Tribal Sub Plan fund utilised	100	82.98
	Scheduled Caste Sub Plan fund utilised	100	77.67
	Palma Ratio of Household Expenditure in Urban India	1	1.41
	Palma Ratio of Household Expenditure in Rural India	1	0.92
Sustainable Cities and Communities	Percentage of wards with 100% door to door waste collection (SBM(U))	100	73.58
	Installed sewage treatment capacity as a percentage of sewage generated in urban areas	68.79	37.58
	Waste processed	100	24.8
	Urban households living in slums	0	5.41
	Houses completed under PMAY as a percentage of net demand assessment for houses	100	3.32

Ensure sustainable consumption and production patterns	Annual ground water withdrawal against net annual availability	70	61.53
Climate Action	Percentage of renewable energy out of total installed generating capacity (including allocated shares)	40	17.51
Life on Land	Total land area covered under forest	33	21.54
	Change in estimated population of wild elephants over 5-year period	0	19.53
	Decadal change in extent of water bodies within forests from 2005 to 2015	0	18.24
	Change in forest area from 2015 to 2017	0	0.21
Peace, Justice and Strong Institutions	Percentage of population covered under Aadhaar	-	89.5
	Percentage of births registered	100	88.3
	Estimated reported corruption crimes	17	34.01
	Cognizable crimes against children	0	24
	Number of courts	33.76	12.83
	Murder rate	1.2	2.4

Source: NITI Ayog, UNDP

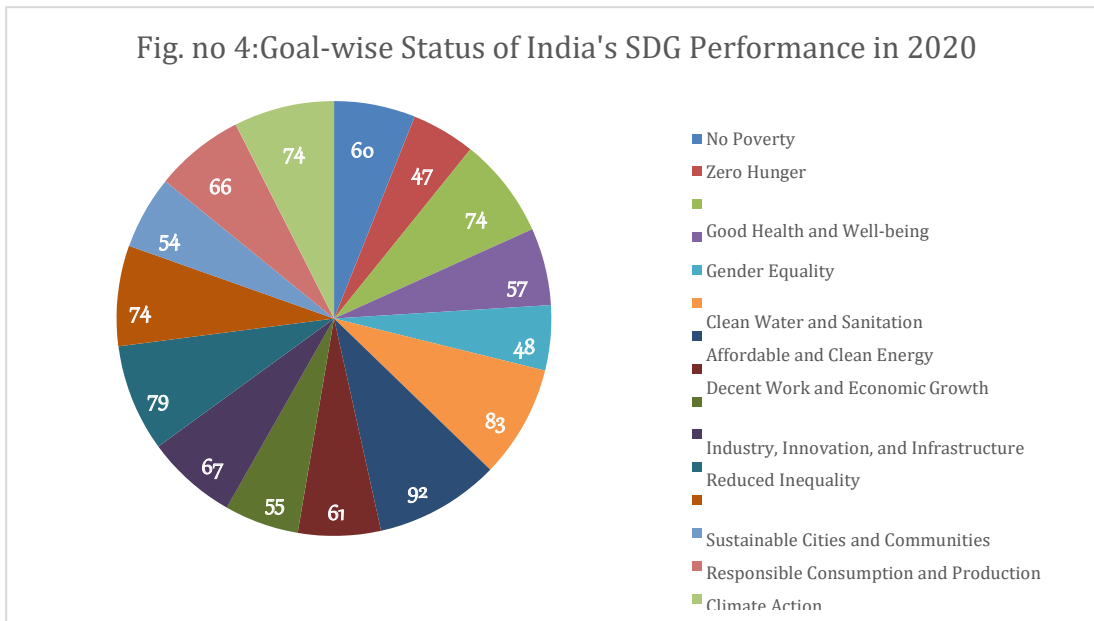

1) No Poverty:

- India achieved 84.75% of the target for providing employment under MGNREGA in 2018, indicating significant progress in reducing poverty through employment generation.
- However, the proportion of the population receiving social protection benefits under Maternity Benefit

and households covered by health insurance remains relatively low, indicating a need for enhanced social welfare programs.

2) Zero Hunger:

- The production of rice, wheat, and coarse cereals per unit area is significantly lower than the target, indicating challenges in achieving food security.

- High rates of anaemia among pregnant women and stunting among children under five years suggest the need for interventions to improve nutritional outcomes.
- 3) Good Health and Well-being:
- Despite efforts to improve immunization rates and maternal health, there is a significant gap in achieving targets for immunization and reducing maternal mortality.
  - The high total case notification rate of tuberculosis indicates the need for strengthened healthcare systems to combat infectious diseases effectively.
- 4) Quality Education:
- Learning outcomes in language and mathematics are below the target, highlighting challenges in providing quality education.
  - The average annual dropout rate at the secondary level is high, indicating issues with retention and completion of schooling.
- 5) Gender Equality:
- The sex ratio at birth is below the target, indicating gender-based discrimination and preference for male children.
  - The high prevalence of spousal violence among married women underscores the need for gender-sensitive interventions and policies.
- 6) Clean Water and Sanitation:
- While progress has been made in providing individual household toilets and safe drinking water, challenges remain in achieving 100% coverage and maintaining sanitation standards.
  - The percentage of districts verified to be open defecation-free is lower than the target, highlighting the need for sustained efforts in sanitation promotion.
- 7) Sustainable Cities and Communities:
- The percentage of urban households living in slums is higher than the target, indicating challenges in ensuring adequate housing and urban development.

- The low percentage of houses completed under PMAY suggests constraints in meeting housing demand and addressing homelessness.

8) Climate Action:

- The percentage of renewable energy out of total installed generating capacity is below the target, indicating the need for greater investments in renewable energy sources.
- Efforts to preserve land areas under forests and wildlife habitats are crucial for biodiversity conservation and mitigating climate change effects.

9) Peace, Justice, and Strong Institutions:

- While the percentage of the population covered under Aadhaar is high, indicating progress in digital identity initiatives, challenges remain in ensuring access to justice and combating corruption and crime.

Overall, the analysis reveals areas of progress and challenges in achieving sustainable development goals, emphasizing the importance of targeted interventions and policy reforms to address key development issues.

**Table 4: Categorization of Indian States and UTs by Performance Level**

Sr. No	Category	States and UTs (shown in alphabetical order)
1	Achiever	
2	Front Runner	Andaman and Nicobar Islands, Andhra Pradesh, Chandigarh, Delhi, Goa, Gujarat, Haryana, Himachal Pradesh, Jammu and Kashmir, Karnataka, Kerala, Ladakh, Lakshadweep, Maharashtra, Mizoram, Puducherry, Punjab, Sikkim, Tamil Nadu, Telangana, Tripura, Uttarakhand
3	Performer	Arunachal Pradesh, Assam, Bihar, Chhattisgarh, Dadra and Nagar Haveli, Daman and Diu, Jharkhand, Madhya Pradesh, Manipur, Meghalaya, Nagaland, Odisha, Rajasthan, Uttar Pradesh, West Bengal
4	Aspirant	



the categorization of Indian states and Union Territories (UTs) into development categories reveals a clear stratification based on their progress towards achieving developmental goals. The "Front Runner" category includes a diverse group of 22 states and UTs, such as Andaman and Nicobar Islands, Andhra Pradesh, and Tamil Nadu, among others. These regions have shown commendable progress across various sectors. The "Performer" category comprises 15 states and UTs, including Arunachal Pradesh, Bihar, and West Bengal, which have made advancements but still face significant challenges.

### Conclusion Achiever

- States and Union Territories categorized as "Achiever" represent those that have consistently demonstrated high performance and significant progress across various developmental indicators.
- These regions have effectively implemented policies and initiatives leading to notable improvements in socio-economic indicators and overall well-being.
- While specific achievements may vary, "Achiever" states and UTs serve as models of success and exemplify effective governance and development strategies. p Front Runner:
- The states and UTs classified as "Front Runner" exhibit commendable progress and development across multiple sectors, although not as consistently high as the "Achiever" category.
- These regions have made substantial strides in areas such as education, healthcare, infrastructure, and economic growth, positioning them as frontrunners in the journey towards sustainable development.
- "Front Runner" states and UTs often serve as catalysts for innovation and best practices, inspiring others to emulate their success and drive further progress. p Performer:
- States and UTs falling under the "Performer" category represent regions that have made progress in various aspects of development but still face significant challenges and disparities.
- While these regions may have implemented initiatives aimed at improving socio-economic

conditions, they continue to grapple with issues such as poverty, unemployment, and inadequate infrastructure.

- The "Performer" category highlights the need for targeted interventions and policy reforms to address existing gaps and accelerate progress towards sustainable development goals.

### p Aspirant

- The states and UTs labeled as "Aspirant" comprise regions that are in the initial stages of their development journey and have yet to achieve significant progress across key indicators.
- These regions often face systemic challenges, including limited resources, infrastructure deficits, and socio-economic disparities, hindering their advancement.
- While classified as "Aspirant," these regions hold potential for growth and improvement through strategic investments, capacity building, and policy interventions aimed at unlocking their developmental potential.

Overall, the categorization of states and UTs provides insights into the varying degrees of progress and challenges faced across different regions, emphasizing the importance of tailored approaches and inclusive policies to ensure equitable and sustainable development nationwide.

## CONCLUSION

Overall, the data reflects a concerted effort by Indian states to advance towards SDGs, with an average national growth rate of 15.8% over three years. The varying rates of progress among states underscore the heterogeneity of development challenges and successes across the country. States with higher growth rates can serve as models, sharing best practices and strategies that contribute to their success. Conversely, states with lower growth rates or negative trends need targeted interventions and policy reforms to address their specific developmental hurdles. The collective progress is promising, but consistent and focused efforts are essential to sustain momentum and ensure equitable development across all regions.

The study's findings present a mixed landscape of progress and challenges in India's journey towards achieving sustainable development goals. Notable strides have been made in reducing poverty through employment generation under MGNREGA, with 84.75% of the target achieved in 2018. However, the low coverage of social protection benefits and health insurance underscores the need for more robust social welfare programs.

In addressing hunger, the production of key cereals falls short of targets, compounded by nutritional deficiencies among pregnant women and children, signaling an urgent call for interventions to secure food security and improve health outcomes.

Healthcare systems face significant hurdles, with gaps in immunization rates and maternal health services, alongside a high incidence of tuberculosis, necessitating stronger healthcare infrastructure and services.

Educational challenges are evident from subpar learning outcomes and high dropout rates at the secondary level, highlighting the critical need for enhancing the quality of education and student retention.

Gender inequality persists, as indicated by skewed sex ratios at birth and prevalent spousal violence, demanding gender-sensitive policies and societal change.

In terms of sanitation and clean water, despite progress in infrastructure, complete coverage and maintenance remain elusive goals. Similarly, urban development faces setbacks with a high percentage of urban households in slums and unmet housing demands under

PMAY.

Climate action calls for increased investment in renewable energy and conservation efforts to protect forests and wildlife habitats, crucial for biodiversity preservation and climate change mitigation.

Lastly, while digital identity initiatives like Aadhaar coverage show promise, access to justice, corruption control, and crime reduction remain areas needing attention to foster peace, justice, and strong institutions.

Overall, the analysis underscores the imperative for targeted interventions and policy reforms to bridge gaps and accelerate India's progress towards comprehensive sustainable development.

The absence of states or UTs in the "Achiever" category suggests that there is room for improvement even among the best-performing regions. The "Front Runner" states and UTs are well-positioned to continue their development trajectory and potentially move into the "Achiever" category with sustained efforts. Meanwhile, the "Performer" states and UTs need focused strategies to address their developmental challenges. This categorization serves as a benchmark for assessing progress and identifying areas where targeted interventions are necessary to ensure balanced and inclusive growth across all regions.

## REFERENCE

1. <https://sdgs.un.org/goals>
2. <https://www.undp.org/sustainable-development-goals>

# Role of Faculties in Achieving Excellence in Higher Education

Suresh D Mane

Principal

Dr D Y Patil Prathisthan's College of Engineering

SN, Kolhapur, Maharashtra

✉ mane.suresh@gmail.com

## ABSTRACT

Engineering education in India as on 2023-24 is going through a problem with excess supply and reduced demand. We see that our neighbour China has grown into global leader, super power and world leader in manufacturing catering to 25% of global manufacturing by value. India in comparison is far behind. The reason of phenomenal growth of China in the last 3 decades is its education policy coupled with political will. Education shall improve by making the learning outcomes clear and ensuring their attainment. Outcome based education is improving the quality of technical education in India and accreditation by NBA is based on OBE. This study dwells upon the exposure of faculty members about the nuances of accreditation be it NAAC or NBA which are popular on date. A questionnaire with 20 questions was designed and administered via e mail to the colleagues working in engineering institutions in the states of Karnataka, Maharashtra and Goa. The responses is very encouraging as over 70% respondents know the details of accreditation, its criteria's, validity, need and advantages. The requirements from individual faculty members to facilitate attainment of NBA accreditation in an engineering institution are also provided. The respondents are quite positive on accreditation and its relevance in today's education scenario and 100% respondents are aware of NAAC and NBA accreditation and 30% about ABET certification.

**KEYWORDS** : *Engineering education, Learning outcomes, Program outcomes, Course outcomes.*

## INTRODUCTION

This Engineering Education in India is going through a problem with excess supply and reduced demand in most of the states. We see that our neighbour China has grown into global leader, super power and world leader in manufacturing catering to 25% of global manufacturing by value [1]. India in comparison is far behind at sixth place behind China, US Japan, Germany and South Korea. The reason of phenomenal growth of China in the last 3 decades is its education policy coupled with political will. Education undoubtedly shall improve by making the learning outcomes clear and ensuring their effective attainment. Learning outcomes (LO) are few statements that describe the knowledge or skills students should acquire by the end of a particular course, or program. LO helps students understand why that knowledge and those skills will be useful to them. They focus on the context and potential applications of knowledge and skills, help students connect learning

in various contexts, and help teacher's assessment and evaluation. Learning outcomes are few statements that describe the knowledge or skills students should acquire by the end of a particular course, or program LO helps students understand why that knowledge and those skills will be useful to them. US has Accreditation Board for Engineering and Technology for certifying its engineering education and is a member of Washington accord. After the Washington accord was signed in 1989 India became a signatory to Washington Accord in 2014. This treaty enables graduates of one nation to pursue career in other nation duly considering the degrees to be equivalent. In 2018 Washington Accord has 20 signatory nations which are focussing on their technical education with outcome based objectives. Bologna declaration was signed in 1999 which was signed by 36 European nations. This declaration focus on outcome based education and equivalence of degrees awarded by member nations.

In India, The National Board of Accreditation (NBA), was initially established by All India Council of Technical Education (AICTE) in the year 1994, for periodic evaluations of technical institutions & programs basis according to specified norms and standards as recommended by AICTE council [2]. From 2010 NBA became an autonomous institution under MHRD since January 2010. Objectives of NBA include Assurance of Quality and Relevance of Education, especially of the programs in professional and technical disciplines, i.e., Engineering and Technology, Management, Architecture, Pharmacy and Hospitality, through the mechanism of accreditation of programs offered by technical institutions. NBA is quite proactive and has introduced a new process, parameters and criteria for accreditation. These processes are in line with the best international practices and oriented to assess the outcomes of the programme. NBA does allocate importance to the learning outcomes in its accreditation process and has allocated 120 points each under criteria 2, 3 and 150 points under criteria 4 for the under SAR 6.0 of 2018 for UG engineering program under tier II. AICTE has come out with model curriculum in Jan 2018 which is being implemented by the engineering institutions pan India in a phased manner [3]. A new beginning has been made by AICTE and the Course outcomes have been defined for all the individual courses which are very brief (3 to 5 LO). It is quite essential that an exercise need to be undertaken by individual subject faculties in coordination with the Board of Studies (BOS) to elaborate the learning outcomes based on individual modules of the syllabus. These learning outcomes must be refined and made available at all prominent locations for the students to read, understand and ensure achieving the same. Presently even accredited institutions have not brought out the graduate attributes or PO to the knowledge of students in a befitting manner. NBA accredits individual programs unlike like National Accreditation and Assessment Council (NAAC) which accredits the entire university or institution [4].

### WASHINGTON ACCORD

The Washington Accord [5], was originally signed by six countries in 1989, is an International Agreement among bodies responsible for accrediting undergraduate

engineering degree programs. It recognizes the substantial equivalency of programs accredited by those bodies and recommends that graduates of programs accredited by any of the signatory bodies be recognized by the other bodies as having met the academic requirements for entry to the practice of engineering in the area of their jurisdiction.

Washington Accord is an international accreditation agreement for professional engineering academic degrees between the bodies responsible for accreditation in its signatory countries. The full signatories of WA as of 2017 are Australia, Canada, Taiwan, India, Canada, Pakistan, China, Hong Kong, Ireland, Japan, Korea, Malaysia, New Zealand, Russia, Singapore, South Africa, Sri Lanka, Turkey, UK, Philippines and USA. The agreement recognizes that there is substantial equivalence of programs accredited by those signatories. Graduates of accredited programs in any of the signatory countries are recognized by the other signatory countries as having met the academic requirements for entry to the practice of engineering. Recognition of accredited programs is not retroactive but takes effect only from the date of admission of the country to signatory status. The Washington Accord covers undergraduate engineering degrees under OBE approach.

### LEARNING OUTCOMES

The Learning outcomes (LO) are few statements that describe the knowledge or skills students should acquire by the end of a particular course, or program LO helps students understand why that knowledge and those skills will be useful to them. Learning Outcomes of engineering graduates should lead to an understanding of professional and ethical responsibility, an ability to communicate effectively, the broad education necessary to understand the impact of engineering solutions in a global, economic, environmental, and societal context. a recognition of the need for, and an ability to engage in life-long learning. These are the basis of the generation of graduate attributes for engineers which are now taken up as standard Pos.

Engineering Program has about 160 credits which include nearly 40 subjects and 15 laboratories for four year UG program. As AICTE has come out with

CO for the new model curriculum, all the universities should set up committees under BOS to arrive at the learning outcomes of all the subjects and labs under their respective program. These LO should be in detail and clearly spelt out so that the UG students can understand the same. Autonomous institutions too need to undertake similar exercise.

Present education system in India is heavily examination result oriented than being knowledge or outcome oriented. The Indian society is focussing on examination results and as such the students are taking short cuts to obtain better scores and in this process the very meaning of education is taking a beating. Recent comments by India's leading think tanks viz Mohandas-Pai of Infosys and Mr Arvind Gurnami of Tech Mahindra are a grim reminder to this. It's in light of these startling revelations by learned people, high time the nation and its education administrators focus on quality rather than on quantity and mere numbers.

The Indian engineering education has grown leaps and bounds in the recent years [6]. National Board of Accreditation was constituted in 1994 under AICTE to look into the quality assurance aspect of engineering education. Since 2012, NBA has constantly updated its SAR and come out with three different Self assessment reports to evaluate the technical institutions under tier II category with the total marks being unchanged at 1000. In 2012 NBA had 10 different criteria's, thereafter in 2013 January NBA revised its criteria's to 9, and once again in June 2015 NBA has come out with final SAR having 10 different criteria's for accreditation of tier II institutions. It is observed that NBA has consistently increased the marks under criteria number 5 faculty contributions from 150 in 2012 to 175 in 2013 and now recently to 200 marks which now constitutes 20% of the total marks and is the largest criteria.

### OUTCOME BASED EDUCATION

Outcome-based education (OBE) is an educational theory that bases each part of an educational system around outcomes. Here outcomes are nothing but academic goals. By the end of the course or program, each student should have achieved the goal. There is no single specified style of teaching or assessment in OBE; instead, classes, opportunities, and assessments should all help students achieve the specified outcomes.

The role of the faculty adapts into instructor, trainer, facilitator, and/or mentor based on the outcomes targeted. Outcome-based methods have been adopted in education systems around the world, at multiple levels.

### BOLOGNA DECLARATION

The Bologna Declaration is the main guiding document of the Bologna process. It was adopted by ministers of education of 29 European countries at their meeting in Bologna in 1999. It proposed a European Higher Education Area in which students and graduates could move freely between countries, using prior qualifications in one country as acceptable entry requirements for further study in another. The principal aims agreed were: "Adoption of a system of easily readable and comparable degrees". That is to say, countries should adopt common terminology and standards. "Adoption of a system essentially based on two main cycles, undergraduate and graduate. Access to the second cycle shall require successful completion of first cycle studies, lasting a minimum of three years. The degree awarded after the first cycle shall also be relevant to the European labour market as an appropriate level of qualification. The second cycle should lead to the master and/or doctorate degree as in many European countries

### NBA ACCREDITATION

AICTE Approval Process Handbook 2019-20 (Clause 2.7.6): To maintain the quality of Education, 60% of the eligible Courses in any Technical Institution shall be accredited in the next 4 years time, else EoA shall not be issued by the Council. Hence it is essential that all institutions approved by AICTE need to start the process of accreditation at the earliest to ensure that two third of the programs are accredited by NBA by 2023 failing which extension of approval wont be given. As accreditation calls for 3 years documents and long documentation process with undertaking of activities by all stake holders it is advisable that the faculties who are the backbone of any institution be given necessary guidelines about expectations from them in order to facilitate successful implementation of accreditation. Management mainly deals with the finances and the infrastructure investment in most of the institutions and the role of faculties is paramount and hence table 1 shows in detail the role of teacher in an engineering institution.



All records need to be maintained in individual faculty course/personal files/ Departmental files.

**Table 1. Annual Targets for teaching faculties to facilitate NBA Accreditation**

Marks	Topic	NBA Criterion No	Details
40	Results of Subjects handled	3.2,4.2,4.3	Analytical/Numerical Subject- Passing % - 60 Descriptive Subjects/ Theory Subjects - 80
5	Students Projects	3.3	One UGC approved journal publication/ National Conference
5	Student Enrolment	4.1	Participating in Institution Promotional Activity. Interaction with PUC Sc /Polytechnic
5	Students Placement	4.4	Placement Training, Pool Campus, Inviting Companies
5	Professional Activities	4.5	Membership of Professional Bodies like ISTE, IE India, SAE, IEEE, ISHRAE, ASHRAE, ASME and conducting one event / dept annually
5	Faculty Qualification	5.3	All PG holders should enroll for Ph. D by 2020 and complete it by 2025
10	Faculties Competencies	5.5,9.4	Clear One NPTEL Course /annum (4/8/12 Wk) related to subjects handled Handwritten Notes for Each subject handled Solving VTU QP for all subjects handled
5	Innovation by Faculty in teaching & learning	5.6	PPT for all 5 Modules of all subjects being handled Students Lab / Indl Visit – One per year
5	Faculty as participant in FDP/STTP	5.7	One per year – NPTEL courses are recognised as FDP by AICTE from 2018 onwards
5			
5	Research & Development	5.8	One TEQIP/ KSCST/VGST/AICTE proposal/ annum
5	Laboratories Maintenance Safety in Lab	6.2, 6.3	Maintenance of equipment and their calibration. ( Safety Posters/slogans, Students safety )
25	Co Curricular & Extra Curricular Activities	9.7	Participating/Organizing Sports/ Cultural/NCC/ NSS/Swath Bharat Abhiyan Industry Institute Interaction Conducting students Debate, Quiz Guest Lectures/Seminars/Workshops
25	Student Feedback (Once Every Semester)	9.2	60 % Score Minimum ( Only students with 85% attendance can give feedback)

Reviews shall happen ever quarterly in first weeks of April, July, Oct and final annual review in January

## RESULTS AND DISCUSSIONS

Awareness about accreditation is high now as most institutions have applied for accreditation or are in the

process of applying for the same.100% respondents confirmed their awareness about accreditation.



**Fig 1. Responses for awareness on accreditation**

The need for accreditation had various responses which converge to either self improvement, self esteem, image building, recognition or funding from agencies like MHRD, AICTE, UGC for research projects.

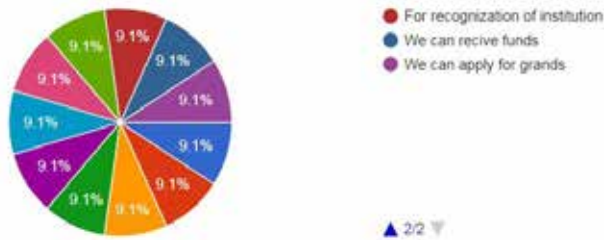

**Fig 2. Responses for Need for accreditation**

NAAC is generally thought of as institution wise accreditation for general arts, commerce and basic science streams with 90% responses. NBA specially meant for engineering, technical institutions with 90% responses.

64 % of respondents gave the right response to the validity period of accreditation to be either 3 years or 6 years and 18% were wrong who mentioned it as 1 or 2 years validity period.

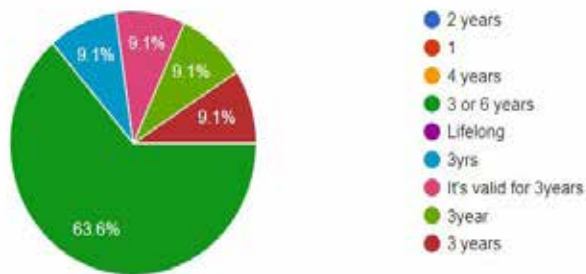

**Fig 3. Responses for validity period for accreditation**

It is observed that 45% gave exact answer and 27.3% gave the near response of 650 points which indicates better understanding of points structure by the respondents.

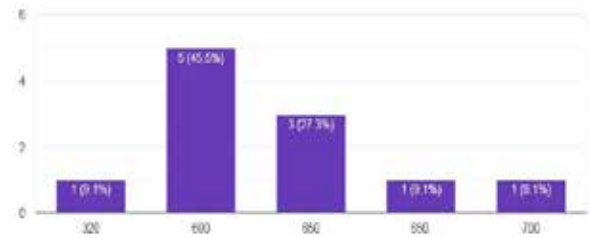

**Fig 4. Responses for No. of points to be eligible for 3 years accreditation**

100% responses were correct for the minimum number of years the documents need to be maintained i.e. 3 years. There will be increased placement opportunities, better companies visiting campus and allied benefits of accreditation apart from image building, value addition to faculties and admissions.

Awareness about Blooms taxonomy levels indicate 55 % are aware and 45% are unaware. This is an area of concern and there should be knowledge dissemination among staff for the same. The response to awareness of Course Outcomes and learning outcomes is 100% but 55% respondents only are aware of PEO Program Educational Objectives and hence needs dissemination.

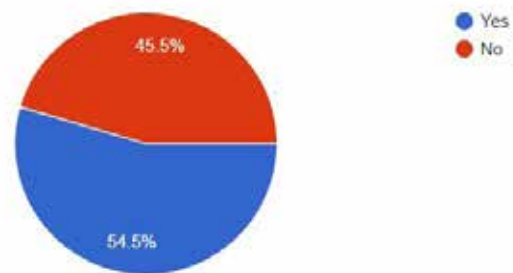

**Fig 5. Responses for Awareness about PEOs**

**CONCLUSION**

Accreditation is here to stay and is no more optional. It is imperative that all stakeholders in higher education be prepared for the same. The survey indicates that the awareness per se is increasing which is a healthy indicator. Many institutions have hired external

consultants, softwares to make their task easy. India with 40,000 higher educational institutions there is still a long way to go before all of them are covered under the cycles of accreditation. Faculties too are updating their knowledge and believe that accreditation shall improve their job satisfaction and improve the quality of education at large. AICTE recently on 1.3.19 has come out with detailed guidelines of 360 degree feedback for faculties which include Teaching, Students feedback, ACR, Contribution to Institute, Contribution to Department and Contribution to Society. It's a welcome move to ensure all round feedback and proper appraisal of faculties. In the present era of disruptive innovation, the role of faculties is gaining more importance.

## REFERENCES

1. U.S. Manufacturing in International Perspective Marc Levinson Section Research Manager February 21, 2018 Congressional Research Service 7-5700 [www.crs.gov](http://www.crs.gov)
2. NBA, Evaluation Guidelines for UG Engineering Program under Tier II, <http://www.nbaind.org/files/evaluation-guidelines-pg-v0.pdf>
3. Quality Education Mandate AICTE, [https://www.aicte-india.org/sites/default/files/QE\\_Mandate\\_Manual.pdf](https://www.aicte-india.org/sites/default/files/QE_Mandate_Manual.pdf)
4. Suresh D. Mane, "NBA and NAAC accreditation of UG Engineering Programmes/Colleges in India: A Review", IJSEAS Vol. I, Issue 6 pp 203-211 ISSN: 2395-3470
5. International Engineering Alliance, Washington Accord, <http://www.ieagreements.org/accords/washington/>
6. Suresh D. Mane, "Accreditation of Engineering Programmes in India: Enhanced Role of Teaching Fraternity", IJSEAS Vol. I, Issue 6 pp 39- 45 ISSN: 2395-3470 [www.ijseas.com](http://www.ijseas.com)

# Fostering Global Development: A Framework for Institutes to Contribute to SDGs 1, 5, and 8 through the Garment Manufacturing Training Center

**Ganesh Rathod**

✉ ganeshrthd883@gmail.com

**Abhijeet Mane**

✉ abhi.m.mane@gmail.com

**Suresh Mane**

✉ mane.suresh.dypcoesn@gmail.com

Dr. D. Y. Patil Pratisthan's College of Engineering  
Salokhenagar, Kolhapur  
Affiliated to Shivaji University  
Kolhapur, Maharashtra

## ABSTRACT

This paper offers a realistic framework for institutes aiming to make meaningful contributions to Sustainable Development Goals (SDGs) 1, 5, and 8. Using the Garment Manufacturing Training Center (GMTC) as a case observe, the paper outlines a way via which institutes can align with governmental schemes, offer infrastructure, and aid talent improvement programs, contributing to SDG 8 (Decent Work and Economic Growth). By doing so, institutes can enhance employability, empower ladies, and make an immediate impact on poverty reduction (SDG 1). The study additionally emphasizes gender equality (SDG 5), showcasing the worldwide importance of such initiatives and encouraging institutes to shift their recognition from inner development to contributing to broader worldwide goals. The study digs into the transformative impact of GMTC, focusing on entrepreneurship, employment, and gender equality, aligning with the United Nations Sustainable Development Goals .Over the years 2021-22 and 2022-23, GMTC has established promising effects, contributing to the creation of entrepreneurs and increased employment possibilities. The number of marketers rose from 18 to 32, and individuals hired in industries increased from 48 to 87. Beyond the numerical achievements, the studies underscores the socio-financial contribution of GMTC to the community, aligning with the broader dreams of poverty remedy, sustainable development, and gender inclusivity. This paper ambitions to inspire institutes to replicate such fashions, fostering collaboration with governmental our bodies, and playing a proactive role in addressing worldwide challenges. Through the GMTC case study, the paper showcases the potential of rural institutes in imposing sustainable practices and empowering girls, making a tangible effect on poverty reduction.. The paper aims to inspire institutes to register for government schemes, leverage existing infrastructure, and actively participate in fostering economic independence in their communities.

**KEYWORDS** : *Sustainable Development Goals, Women Empowerment, Garment Manufacturing, Poverty eradication, Social Economic Growth.*

## INTRODUCTION

The Sustainable Development Goals (SDGs), devised by the United Nations, signify a global commitment to address diverse challenges and promote a sustainable future. Among these, SDG 1 stands out, centering on the elimination of poverty. Although the Government of India has made progress in achieving these goals, persistent challenges, especially in

regions like Maharashtra, necessitate innovative and collaborative approaches. As unemployment rates surge, the detrimental cycle of poverty exacerbates, disproportionately affecting vulnerable communities. Recognizing the interplay of SDG 1, SDG 5, and SDG 8, which tackles gender inequality and promotes decent work and economic growth, reveals a pivotal aspect of poverty alleviation – the economic empowerment

of women. Maharashtra, akin to numerous regions globally, contends with gender imbalances that compound poverty-related challenges. Through the economic empowerment of women, we not only elevate individual families but also contribute to a fairer and more just society.

This paper delves into a transformative model that leverages private organizations to collaborate with governmental initiatives, creating a ripple effect of change. We explore the potential of these organizations to act as catalysts for economic empowerment, particularly in rural areas where the need is pronounced. By aligning with government schemes, institutes can play a pivotal role in not only reducing unemployment but also fostering an environment conducive to women's empowerment. The nexus between employment and poverty reduction forms the cornerstone of this initiative. As individuals gain skills and access to employment opportunities, the wheels of socio-economic progress are set in motion. This approach aligns seamlessly with the larger agenda of the government and international bodies to create a skilled and employable workforce.

One of the powerful avenues for achieving this goal is through skill development programs. The Garment Manufacturing Training Center (GMTC), an initiative of our esteemed institute Dr. D. Y. Patil Pratisthan's College of Engineering, Salokhenagar, Kolhapur, India, exemplifies how a focused and strategic approach can yield transformative outcomes. This paper unfolds the narrative of GMTC, showcasing how it contributes not only to SDG 1 and SDG 5 but also acts as a beacon for other private organizations to join hands with governmental efforts.

The significance of such collaborations lies not only in mitigating immediate socio-economic challenges but also in fostering sustainable, community-driven development. As we navigate through the intricate threads of poverty, gender inequality, and unemployment, the GMTC model emerges as a testament to the potential held by private organizations to be change agents. Through this paper, we invite a broader dialogue on how private institutions can actively participate in reshaping the socio-economic landscape, aligning their goals with the global vision of sustainable development.

## LITERATURE REVIEW

This literature review aims to provide a comprehensive understanding of OBE methodology, focusing on course outcomes attainment and the assessment tools used in higher education institutions. Education is a powerful tool for empowerment, and governments worldwide are striving to provide quality education to their citizens at an affordable cost [1]. Outcome-based education plays a crucial role in achieving this goal by focusing on measurable learning outcomes. Outcome-based education (OBE) methodology has gained significant attention in higher education institutions worldwide due to its potential to enhance student learning outcomes and program quality [2]. OBE focuses on defining clear and measurable course outcomes that align with program objectives [3]. By explicitly stating the expected knowledge, skills, and attitudes that students should acquire, OBE provides a framework for designing effective curriculum and assessment strategies. This approach emphasizes student-centered learning, where learners actively engage in the learning process and take responsibility for their own progress. Through the implementation of OBE, institutions aim to produce graduates who possess the necessary competencies to succeed in their chosen fields [4].

Assessment plays a crucial role in outcome-based education, as it provides evidence of students' attainment of course outcomes and guides instructional decision-making [5]. Various assessment methods and tools are employed to measure student learning outcomes, including traditional exams, projects, portfolios, and performance-based assessments [6]. Traditional exams, such as multiple-choice tests, are commonly used to assess students' knowledge and understanding of course content [7]. However, they may not capture higher-order thinking skills or the ability to apply knowledge in real-world contexts. In contrast, performance-based assessments, such as simulations or case studies, provide opportunities for students to demonstrate their skills and competencies in authentic situations. These assessments often require students to apply their knowledge, analyse complex problems, and make informed decisions. By using a combination of assessment methods, instructors can obtain a comprehensive understanding of students' learning outcomes and provide targeted feedback for



improvement [8]. The implementation of outcome-based education requires a systematic approach to curriculum design and development [9]. Curriculum mapping, a process that involves aligning course outcomes, instructional strategies, and assessment methods, is a valuable tool in ensuring the coherence and alignment of the curriculum. Through curriculum mapping, instructors can identify gaps, redundancies, and areas for improvement in the curriculum, leading to a more integrated and meaningful learning experience for students. Additionally, curriculum mapping facilitates the identification of opportunities for interdisciplinary learning and the integration of real-world applications into the curriculum [10]. By aligning the curriculum with industry needs and societal demands, institutions can better prepare students for the challenges of the workforce and contribute to their overall empowerment. The author in [11], conducted a study in engineering colleges within the Belagavi region of Karnataka, India, involving faculty and final year engineering students. The research identified nine key suggestions to improve the employability of engineering graduates, with a focus on enhancing student engagement through seminars, assignments, and mini projects, as well as promoting proactive learning among teachers through annual training and journal paper publication.

The implementation of outcome-based education requires a supportive institutional environment that fosters collaboration, professional development, and continuous improvement [12]. Institutions need to provide faculty members with the necessary resources, training, and support to effectively design and implement outcome-based curriculum [13]. Professional development programs can help instructors develop a deep understanding of the principles and practices of outcome-based education and equip them with the skills to align course outcomes, instructional strategies, and assessment methods. Furthermore, creating a culture of continuous improvement is essential for the successful implementation of outcome-based education. Institutions should establish mechanisms for collecting and analyzing data on student learning outcomes, soliciting feedback from stakeholders, and using evidence-based practices to enhance the quality of education [14]. By fostering a supportive and collaborative environment, institutions can empower

faculty members to embrace outcome-based education and contribute to the overall success of the educational institution [15]. As the accreditation bodies in India ie NAAC and NBA have adopted the OBE in their revised framework from 2015, it is imperative that the role of teaching faculty has new dimensions added to it [16]. Both the NAAC accreditation (University/ Institute accreditation) and NBA accreditation have various criteria and metrics to objectively assess and accredit the institutes based on benchmark's set by them [17].

## METHODOLOGY

The approach to implementing the successful Garment Manufacturing Training Center (GMTC) model involves a comprehensive 11-step process. The initiation of this methodology includes leveraging government services such as Mahila Arthik Vikas Mahamandal (MAVM) and Skill India.com. The 11 crucial steps outlined in Figure 1 form the foundation for the effective establishment and functioning of the GMTC model. These steps are meticulously designed to ensure a systematic and successful execution of the training center, aligning with the objectives of promoting skill development and economic empowerment. Each step in the methodology plays a distinct role, contributing to the overall success of the GMTC model and its impact on the community. The figure serves as a visual representation of the sequential and interconnected nature of these steps, highlighting their importance in the implementation process.



**Figure 1. Sequential Steps for GMTC Model.**

The methodology involves a systematic breakdown of each step, providing a comprehensive understanding of the processes involved in implementing the successful Garment Manufacturing Training Center (GMTC) model. Below is an in-depth explanation of each step:

### Mobilization

The first step in implementing the Garment Manufacturing Training Center (GMTC) model is

mobilization, a comprehensive approach that involves team members actively engaging with the community on a door-to-door basis. The primary aim is to create widespread awareness about GMTC, emphasizing women's empowerment as a key tool in addressing poverty, in alignment with Sustainable Development Goal 1. Through personalized interactions, the team communicates the transformative impact of women acquiring skills in garment manufacturing. This connection is crucial in linking skill development to poverty reduction, establishing GMTC as a catalyst for positive change in the community. The mobilization process strategically aligns the initiative with broader goals, contributing to Sustainable Development Goal 1 by addressing the root causes of poverty through skill enhancement. Beyond awareness, mobilization fosters active community engagement, ensuring that the GMTC program is tailored to the specific needs of the community. By empowering women with skills in garment stitching, GMTC not only enhances employability but also instils confidence and independence. This phase lays the groundwork for sustainable change, instilling a sense of purpose within the community and ensuring enthusiastic commitment to subsequent steps in the GMTC implementation process.

### **Social Media Advertisements**

The second crucial step in the Garment Manufacturing Training Center (GMTC) model implementation is Social Media Advertisements, leveraging platforms like WhatsApp and Facebook to extend its reach into rural communities. This strategic use of social media aligns with contemporary communication channels and ensures that the GMTC initiative is accessible to a wide audience. Social Media Advertisements act as a powerful tool to disseminate information about GMTC, reaching beyond the geographical constraints of door-to-door mobilization. By utilizing platforms like WhatsApp and Facebook, the team ensures that the initiative's message penetrates even the remote corners of the rural community, promoting inclusivity and broad participation. Through well-crafted advertisements, the team communicates the benefits and opportunities provided by GMTC, emphasizing how women can enhance their skills in garment stitching, ultimately leading to improved employability and economic

independence. This aligns with the broader goal of addressing poverty, directly linking GMTC's offerings to the aspirations of the community. The use of social media facilitates real-time communication, allowing interested individuals to engage with GMTC promptly. It provides a platform for queries, discussions, and sharing success stories, fostering a virtual community around the initiative. This step not only ensures wider awareness but also establishes GMTC as a dynamic and responsive program in tune with the communication preferences of the target audience.

### **Calling and Counselling**

The third integral step in the implementation of the Garment Manufacturing Training Center (GMTC) model is "Calling and Counselling," a process designed to engage with potential candidates and guide them through the initiation of their journey with GMTC. This step involves a combination of telephonic calls and personalized counselling sessions, aiming to identify interested individuals and provide them with essential information. Through telephonic calling, the GMTC team establishes direct communication with potential candidates. This initial interaction serves as a platform to introduce the candidates to the GMTC initiative, outlining its objectives and the benefits of participating. It allows the team to gauge the level of interest and enthusiasm among the individuals, paving the way for targeted counselling sessions. Personal counselling sessions become instrumental in understanding the background, aspirations, and eagerness of the candidates. These sessions offer a more intimate setting where individuals can express their motivations and concerns. The importance of the GMTC training is communicated during these sessions, emphasizing how acquiring skills in garment stitching can lead to enhanced employability and economic independence, directly addressing the overarching goal of poverty reduction. A key component of the counselling process is to communicate the significance of commitment. Candidates are informed about the importance of registering for GMTC training and the expectation that once registered, backing off is not permissible. This ensures a sense of responsibility and dedication, fostering a commitment to the program. The Calling and Counselling step serves as a bridge between raising

awareness through social media advertisements and the actual enrolment of candidates. It adds a personal touch to the outreach process, allowing the GMTC team to address individual concerns and tailor information to better resonate with the aspirations of potential participants.

### **Document Submission**

This phase represents a critical juncture in the comprehensive process of implementing the Garment Manufacturing Training Center (GMTC) model. During this stage, the GMTC team collects essential documents, primarily the Aadhar card and educational records, from individuals who have expressed interest in enrolling for the training program. This step is designed to formalize the registration process, ensuring that accurate and verified information is obtained from each prospective participant. The Aadhar card, a unique identification document, serves as a fundamental means of authenticating the individual's identity. Collecting this information aligns with regulatory requirements and establishes a secure foundation for participant records within the GMTC framework. Additionally, the submission of educational documents plays a crucial role in assessing the educational background of the candidates. This information aids in tailoring the training programs to suit the diverse educational levels of the participants. Understanding the educational qualifications of the candidates allows for the customization of training modules, ensuring that the content is appropriate and beneficial for each individual. The Document Submission stage is not merely a procedural formality but a strategic approach to building a comprehensive profile of the participants. By collecting these documents, the GMTC team gains insights into the demographic and educational diversity of the cohort, facilitating the development of a training curriculum that can cater to a wide range of learners. Furthermore, this step fosters transparency and accountability within the GMTC initiative. It establishes a clear record-keeping system, ensuring that participant information is securely stored and easily accessible. The meticulous collection of documents also sets the stage for future evaluations and assessments, enabling the GMTC team to track the progress and impact of the training program over time.

### **Selection**

This phase represents a crucial step in the meticulous process of implementing the Garment Manufacturing Training Center (GMTC) model. During this stage, the GMTC team undertakes a thoughtful and discerning approach to identify and choose genuinely interested candidates who will proceed with registration and subsequent training. The selection process involves a comprehensive evaluation of the candidates based on various criteria. The team considers factors such as the candidates' level of interest, eagerness to participate, and commitment to the training program. This phase is instrumental in ensuring that individuals who are genuinely motivated to acquire skills in garment manufacturing and contribute to their economic empowerment are given the opportunity to enrol. Transparency and fairness are core principles during the selection process. The GMTC team ensures that the criteria for selection are communicated clearly to the candidates, fostering an environment of openness and trust. Candidates who meet the outlined criteria are then invited to proceed with the registration process, marking the transition from selection to the next stage of the GMTC journey.

### **Registration**

The "Registration" phase marks a pivotal step in the operationalization of the Garment Manufacturing Training Center (GMTC) model. During this stage, the GMTC team undertakes the formal process of enrolling selected candidates into the government portal, specifically the official Skill India platform ([www.skillindia.com](http://www.skillindia.com)), signifying a key transition from candidate selection to active participation in the training program. The registration process is characterized by a meticulous and organized approach to ensure that the chosen candidates are seamlessly integrated into the larger framework of skill development and empowerment. The team guides the selected individuals through the steps involved in registering on the Skill India portal, emphasizing the importance of this formal documentation for availing training opportunities.

### **Batch Creation**

The "Batch Creation" phase is a crucial component of the Garment Manufacturing Training Center (GMTC)

model, representing the transition from individual registrations to the structured formation of cohorts ready for the training program. This phase is meticulously designed to optimize the learning experience, foster collaboration among participants, and streamline the administrative aspects of managing a training cohort. During this phase, the GMTC team orchestrates the assembly of a cohesive batch comprising 30 candidates who will undergo a comprehensive three-month training program. The process involves careful consideration of factors such as diversity, skill levels, and compatibility among candidates to ensure a dynamic and enriching learning environment, emphasizing the importance of this formal documentation for availing training opportunities.

### **Training**

The "Training Phase" at the Garment Manufacturing Training Center (GMTC) is a pivotal segment where participants receive hands-on instruction and guidance, shaping their skills in fashion designing. This phase, supported by the institute, ensures a conducive learning environment equipped with 20 sewing machines. Here, the participants are introduced to a comprehensive syllabus that forms the foundation for their journey in the realm of fashion design. Within this phase, our institute provides the essential infrastructure, including the 20 sewing machines, creating an environment conducive to effective and practical training. Each day, participant's attendance is digitally recorded and updated in the portal, ensuring transparency and real-time monitoring of their engagement in the program. The skill development training program focuses on fashion designing, delivering a well-structured curriculum that addresses both theoretical principles and hands-on experience. Covering a range of garment types and design elements, participants are equipped with practical skills essential for entrepreneurial ventures. The specific modules covered in the fashion designing course include a variety of garments, from basic items like fancy petticoats to more intricate designs like collar kurtas and umbrella dresses. Practical aspects, such as sleeve types, salwar types, and blouse variations, are integral components of the curriculum, ensuring a well-rounded understanding of garment construction.

The incorporation of sewing machines into the training environment underscores the commitment of the institute to provide tangible resources for skill development. These machines play a crucial role in translating theoretical knowledge into practical expertise, preparing participants for successful entrepreneurial pursuits and significantly contributing to SDG 5 – Gender Equality and SDG 1 – Poverty Eradication.

### **Workshops**

The "Workshops" step in the Garment Manufacturing Training Center (GMTC) model is a crucial element that enhances the overall training experience for participants. By organizing guest lectures featuring industry experts, bank officers, and professionals, the institute enriches the learning journey of the participants. These workshops serve as a bridge between theoretical training and real-world application. Industry experts bring practical insights and real-life experiences to the participants, offering a deeper understanding of the intricacies of the garment manufacturing and fashion industry. Bank officers play a pivotal role in these workshops, shedding light on government loan schemes and financial support available for aspiring entrepreneurs. Participants gain valuable knowledge about the financial aspects of starting and sustaining their own garment-related businesses. This aligns with SDG 1 – Poverty Eradication, as the workshops empower individuals with the financial literacy needed to access resources and create self-employment opportunities.

### **Inspection**

This phase in the Garment Manufacturing Training Center (GMTC) model is a critical step where government representatives play a vital role in ensuring the effectiveness and quality of the training program. During this phase, employees from the Employment Department or Corporation Department visit the training center to conduct a thorough inspection. One key aspect of the inspection involves the verification of candidates' identities using Aadhar cards. This step ensures that the individuals participating in the training program are genuine and eligible beneficiaries. This aligns with the



need for transparency and accountability in government-sponsored initiatives, contributing to the integrity of the program. The government representatives also actively observe the ongoing training sessions. This observation allows them to assess the practical implementation of the training curriculum, ensuring that it meets the expected standards. Additionally, the inspection involves checking attendance records. This meticulous review ensures that participants are consistently attending the training sessions, a crucial factor in the success of any skill development program

Furthermore, the government representatives engage with participants through oral questioning. This interactive approach allows inspectors to gauge the participants' understanding of the training, their awareness of the associated government schemes, and their ability to articulate any challenges or concerns they may be facing.

### Assessment and Certification

This phase in the GMTC model is a crucial step designed to evaluate participants' comprehension and practical skills. This phase employs a dual approach, combining online exams with multiple-choice questions (MCQs) and practical performance assessments to ensure a comprehensive evaluation. Online exams with MCQs serve as a structured method to assess participants' theoretical knowledge. These assessments cover the theoretical aspects of the fashion designing course, ensuring that participants have a solid understanding of the concepts taught during the training. Complementing the theoretical evaluation, practical performance assessments are conducted to gauge participants' hands-on skills. Participants are required to demonstrate their proficiency in various aspects of garment stitching, reflecting the practical application of the knowledge gained during the training.

Upon successful completion of the assessments, participants receive a government-authorized certificate. This certificate is a tangible recognition of their achievements and signifies their competency in garment stitching. The inclusion of grades on the certificate provides a detailed overview of their performance, further acknowledging their dedication and proficiency in the field. This certification process supports SDG

1 – No Poverty and SDG 5 – Gender Equality by enhancing participants' employability and promoting economic independence, especially among women. The government-issued certificate holds substantial value in the job market and entrepreneurial endeavours. It serves as a formal endorsement of participants' skills and knowledge, opening avenues for employment opportunities. Additionally, for those aspiring to start their own businesses, the certificate adds credibility and facilitates access to various government schemes and support programs. In essence, the "Assessment and Certification" phase not only measures participants' academic and practical achievements but also empowers them with a recognized credential that can significantly impact their future endeavours. This aligns with the overarching goal of the GMTC model, contributing to poverty reduction, gender equality, and economic empowerment within the community.

## RESULTS AND DISCUSSION

The data presented in Figure 2 reflects the growth and impact of the Garment Manufacturing Training Center over the two consecutive years, showcasing an encouraging trend in the number of entrepreneurs created and participants employed in industries as a result of the training programs.



**Figure 2. Employment Details**

In the year 2021-22, GMTC contributed to the creation of 18 entrepreneurs who ventured into various business initiatives. This number increased significantly to 32 entrepreneurs in the subsequent year, indicating a positive trend in fostering entrepreneurship. The data also highlights the number of participants who secured employment in industries after completing the



training programs. In 2021-22, 48 participants found employment, showcasing the immediate impact of the training on enhancing employability. This figure further increased to 87 participants in 2022-23, signifying a substantial growth in providing employment opportunities. The combined effect of entrepreneurship development and increased employment demonstrates the holistic impact of GMTC on individuals. Not only does it empower individuals to start their own businesses, but it also enhances their employability, contributing to the broader goals of poverty reduction (SDG 1), women empowerment (SDG 5) and Economic Growth (SDG 8).

The upward trajectory in both the number of entrepreneurs and employed participants indicates the effectiveness and success of the GMTC model. The consistent growth suggests that the training programs are gaining traction and making a tangible difference in the lives of participants. Beyond the numerical figures, the data signifies the socio-economic contribution of GMTC to the community. By creating entrepreneurs and facilitating employment, the training center plays a pivotal role in uplifting individuals and contributing to the overall development of the region. The positive outcomes observed over the two years underscore the potential for scaling up the GMTC model. With the increasing demand for skills and entrepreneurship, the training center can explore opportunities to expand its reach and impact, thereby making a more significant contribution to sustainable development goals. Overall, the data from 2021-22 to 2022-23 reflects a success story for GMTC, showcasing growth in both entrepreneurship and employment opportunities. The center's role in empowering individuals and contributing to local economic development is evident, highlighting the importance of continued support and investment in such skill development initiatives.

## CONCLUSION

India's current SDG Index rank of 111 out of 166 countries, with an SDG index score of 63.5, emphasizes the urgent need for complete strategies to strengthen sustainable development goals. There is a tremendous scope for improvement, and our research paper offers a practical framework through the case have a look at of the Garment Manufacturing Training Center (GMTC)

to address these demanding situations. By aligning with governmental schemes, offering infrastructure, and assisting skill improvement programs, institutes can not only enhance employability but also empower women, contributing directly to poverty reduction. The recognition on SDG 1 (Poverty Eradication), SDG 5 (Gender Equality), and SDG 8 (Decent Work and Economic Growth) within our framework demonstrates a complete method that aligns with broader worldwide desires. Significantly, our version has caused a splendid effect on employment. Through skill development, the GMTC has cultivated a pool of marketers, with over 50 companies set up by women, who underwent the training. This model has not only equipped individuals with skills but has additionally created a ripple impact, undoubtedly influencing the financial outlook and fostering independence. This paper serves as a clear call for institutes to shift their awareness from inner development to actively contributing to the countrywide and global improvement agenda, mainly in addressing the tricky problems of poverty and gender inequality. The employment effects underscore the transformative potential of such tasks, showcasing the potential of rural institutes to play a pivotal position in sustainable practices, economic increase, and societal empowerment.

As the nation collectively works toward reaching SDGs, institutes have a completely unique opportunity to be substance for alternate, fostering economic empowerment, gender equality, and standard societal properly-being. Our version stands as a testament to how institutes can make contributions tangibly to these objectives, creating a superb impact on people, communities, and the state as an entire.

## REFERENCES

1. Jandrić, Petar, Ana Fuentes Martinez, Charles Reitz, Liz Jackson, Dennis Grauslund, David Hayes, Happiness Onesmo Lukoko et al. "Teaching in the age of Covid-19—The new normal." *Postdigital Science and Education* 4, no. 3 (2022): 877-1015.
2. Pereira, Diana, Irene Cadime, Gavin Brown, and Maria Assunção Flores. "How do undergraduates perceive the use of assessment? A study in higher education." *European Journal of Higher Education* 12, no. 1 (2022): 1-17.

3. MacDonald, Laura, Evan Thomas, Amy Javernick-Will, Jesse Austin-Breneman, Iana Aranda, Carlo Salvinelli, Rita Klees et al. "Aligning learning objectives and approaches in global engineering graduate programs: Review and recommendations by an interdisciplinary working group." *Development Engineering* 7 (2022): 100095.
4. Sugarman, Stephen D. "The Failed Quest for Equal Educational Opportunity: Regulating Education the Way We Regulate Business." *JL & Educ.* 50 (2021).
5. Misbah, Zainun, Judith Gulikers, Wahyu Widhiarso, and Martin Mulder. "Exploring connections between teacher interpersonal behaviour, student motivation and competency level in competence-based learning environments." *Learning Environments Research* (2022): 1-21.
6. Kushari, Berlian, and Lukman Septiadi. "A learning outcome assessment information system to facilitate Outcome-Based Education (OBE) implementation." *Jurnal Pendidikan Teknologi dan Kejuruan* 28, no. 2 (2022).
7. Mukesh, S. "Outcome-based learning: an overview." In *Proceedings of the International Conference on Best Innovative Teaching Strategies (ICON-BITS 2021)*. 2022.
8. Amirtharaj, S., G. Chandrasekaran, K. Thirumoorthy, and K. Muneeswaran. "A systematic approach for assessment of attainment in outcome-based education." *Higher Education for the Future* 9, (2022): 8-29.
9. Harden, Ronald M. "AMEE Guide No. 21: Curriculum mapping: a tool for transparent and authentic teaching and learning." *Medical teacher* 23, no. 2 (2001): 123-137.
10. Joyner, Helen S. "Curriculum mapping: A method to assess and refine undergraduate degree programs." *Journal of Food Science Education* 15, no. 3 (2016): 83-100.
11. Suresh. D. Mane S.P. Dodamani. "Measures for Improving Undergraduate Engineering Education: An Emperical Study in the state of Karnataka". *The International Journal Of Engineering And Science (IJES)*, Volume 4, Issue 4, PP 40-46 (2015). ISSN (e): 2319 – 1813 ISSN (p): 2319 – 1805.
12. Erlinger, Allison. "Outcomes assessment in undergraduate information literacy instruction: a systematic review." *College & Research Libraries* 79, no. 4 (2018): 442.
13. Farmer, Elizabeth A. "Faculty development for problem-based learning." *European Journal of Dental Education* 8, no. 2 (2004): 59-66.
14. Sun, Poi Hun, and Sek Yan Lee. "The importance and challenges of outcome-based education-a case study in a private higher education institution." *Malaysian Journal of Learning and Instruction* 17, no. 2 (2020): 253-278.
15. Syeed, MM Mahbulbul, A. S. M. Shihavuddin, Mohammad Faisal Uddin, Mahady Hasan, and Razib Hayat Khan. "Outcome based education (OBE): Defining the process and practice for engineering education." *IEEE Access* 10 (2022): 119170-119192.
16. Suresh. D. Mane, "Accreditation of UG Engineering Programmes in India: Enhanced Role of Teaching Fraternity. *International Journal of Scientific Engineering and Applied Science (IJSEAS)* - Volume-1, Issue-6, September 2015, ISSN: 2395-3470.
17. Suresh. D. Mane, "NBA and NAAC Accreditation of UG Engineering Programmes/Colleges in India: A Review". *International Journal of Scientific Engineering and Applied Science (IJSEAS)* - Volume-1, Issue-6, September 2015, ISSN: 2395-3470.

# Life Guardian : Leveraging Node.js & Socket.IO for Real-Time Emergency Response and Coordination in Crisis Situations

**Pratik Patil, Tejas Nikam  
Pruthviraj Haladkar, Aditya Chende**

Department of Computer Science & Engineering  
Dr. D.Y.Patil Pratisthan's College of Engineering  
Salokhenagar, Kolhapur, Maharashtra

✉ pratik8560@gmail.com  
✉ tejasnikam4515@gmail.com  
✉ rajhaladkar9808@gmail.com  
✉ adityachende@gmail.com

**Ganesh Rathod**

Assistant Professor

Department of Computer Science & Engineering  
Dr. D.Y.Patil Pratisthan's College of Engineering  
Salokhenagar, Kolhapur, Maharashtra

✉ ganeshrthd883@gmail.com

## ABSTRACT

During emergencies, communication breakdowns and delayed response times heighten casualties. This work presents a cross-platform mobile app designed to revolutionize disaster preparedness and response, addressing critical shortcomings prevalent in traditional systems. The app boasts multifunctionality, allowing users to send alerts, organize safety events, and trigger rescue requests seamlessly. Utilizing Node.js, Express.js, and MongoDB with GeoJSON APIs, its dynamic geolocation feature locates users and nearby rescue agencies within an adjustable 10km radius. Real-time visibility is ensured through Socket.io, enabling the sharing of rescue operation details and live location data of deployed agencies, fostering enhanced coordination. By eliminating reliance on unreliable phone calls, the app bridges the communication gap, facilitating direct interaction between users and rescue agencies. Moreover, it empowers quicker response times by enabling agencies to visualize active operations and optimize resource allocation efficiently. The app's impact is significant, potentially reducing death rates, which in India alone witnessed a sharp increase due to disasters in recent years. By expediting location identification and facilitating improved communication during rescue efforts, the app aims to contribute to mitigating the devastating toll of disasters. Additionally, it empowers users by providing actionable information and immediate access to critical support. Furthermore, the work enhances agency coordination, fostering collaboration and maximizing resource utilization among rescue teams, thereby augmenting overall effectiveness. This mobile app offers a robust solution, leveraging technology to streamline emergency response systems, potentially saving lives and enhancing crisis management outcomes.

**KEYWORDS** : *NodeJs, ExpressJs,Flutter, GeoJSONAPI, SocketIO.*

## INTRODUCTION

In this project, we aim to create a simple disaster management system, which helps people and authorities respond quickly and effectively to disasters like earthquakes, floods, or fires. The system will provide information about disaster preparedness, emergency contacts, and a simple tool for reporting and tracking incidents. Our goal is to build a user-friendly disaster management system to assist people during emergencies, offering guidance, reporting capabilities,

and access to essential resources. This project focuses on creating a simple and user-friendly disaster management system. The aim is to help people respond better to disasters and emergencies. The system is a web application that gives necessary information about all the disasters which are registered on particular location. This information will further be provided to public as an Alert with some precaution which should be follow, also the people who have trap in the disaster such as flood or earthquake will get the exact and live location

of the team who is coming for their rescue. In an ever-changing world, where natural and man-made disasters pose significant threats to communities, having a robust disaster management system is crucial. The integration of technology has revolutionized disaster preparedness and response, giving rise to specialized software designed to streamline and optimize disaster management efforts. This introduction explores the role and significance of Disaster Management System Software in enhancing preparedness, response, and recovery in the face of adversity. Disasters, whether they stem from natural calamities or human activities, can cause substantial harm to lives, property, and the environment. Timely and efficient response is vital to minimize the impact and save lives. Disaster Management System Software offers a technologically advanced approach to preparedness, enabling swift and well-coordinated responses during these critical moments. Preparedness is the cornerstone of effective disaster management. Disaster Management System Software facilitates comprehensive planning, risk assessment, and scenario modeling to identify vulnerabilities and develop effective strategies. It empowers authorities to allocate resources and establish communication protocols to enhance readiness for any potential disaster. During a disaster, coordination and communication are paramount. Disaster Management System Software acts as a central hub, enabling real-time data sharing, resource allocation, and task assignment among various response teams. This ensures a synchronized and efficient response to mitigate the impact and provide aid to affected communities promptly. Effective resource management is crucial for successful disaster response. Disaster Management System Software employs advanced algorithms and analytics to optimize resource allocation based on the type and scale of the disaster. It ensures that resources such as medical supplies, rescue teams, and equipment are allocated where they are needed the most, minimizing delays and optimizing outcomes of the primary security challenges associated with cloud computing is the risk of unauthorized access. Cloud computing providers typically offer multiple levels of security, including access controls and encryption, to prevent unauthorized access. However, if these security measures are not implemented properly or if user passwords are compromised, attackers can gain access to cloud resources and data. This is especially

concerning in the case of cloud storage, where sensitive data may be stored and accessed by multiple users.

## LITERATURE REVIEW

The frequency and intensity of disasters have been increasing globally in recent years. This is due to a number of factors, including climate change, population growth, and urbanization. Disasters can have a devastating impact on human lives and infrastructure. In order to mitigate the impact of disasters, it is essential to have effective and efficient disaster management systems. Technology can play a vital role in disaster and rescue management. It can be used to improve response times, provide real-time information to decision-makers, and connect people who are affected by disasters or are in a danger. There are a number of different technologies that can be used for disaster management and rescue operations, including geographic information systems (GIS), remote sensing, communication systems, and awareness events. The frequency and intensity of disasters have been increasing globally in recent years. This is due to a number of factors, including climate change, population growth, and urbanization. Disasters can have a devastating impact on human lives and infrastructure. In order to mitigate the impact of disasters, it is essential to have effective and efficient disaster management systems. Technology can play a vital role in disaster and rescue management. It can be used to improve response times, provide real-time information to decision-makers, and connect people who are affected by disasters or are in a danger. There are a number of different technologies that can be used for disaster management and rescue operations, including geographic information systems (GIS), remote sensing, communication systems, and awareness events. In a study conducted by [1], observed that in recent years, acts of assault and violence against women are rising at a menacing rate. With escalation of female employees in industries and other sectors of the commercial market, it is now becoming a necessity for females to travel at late hours and visit distant and isolated locations as a part of their work regime. However, the exponential increase in assault, violence and attacks against women in the past few years, is posing a threat to the growth and development of women. Defense isn't the only measure that can suffice against this increasing abuse. A

security solution that creates a sense of safety among women needs to be devised. In instances of attack, it is largely reported that women are immobilized. There is thus, a need of simpler safety solution that can be activated as simply as by pressing a switch and can instantly send out alerts to the near ones of the victim. In this paper we intend to design and implement such a system in the form of a partial wearable and partial portable system. Another recent study [2], figured that recent ubiquitous earthquakes have been leading to mass destruction of electrical power and cellular infrastructures, and deprive the innocent lives across the world. Due to the wide-area earthquake disaster, unavailable power and communication infrastructure, limited man-power and resource, traditional rescue operations and equipment are inefficient and time-consuming, leading to the golden hours missed. With the increasing proliferation of powerful wireless devices, like smartphones, they can be assumed to be abundantly available among the disaster victims and can act as valuable resource to coordinate disaster rescue operations. The basic idea of them is that a set of smartphones carried by survivors trapped or buried under the collapsed infrastructure forms into a one-hop network and sends out distress signal in an energy-efficient manner to nearby rescue crews to assist rescue operations. We evaluate the proposed approach through extensive simulation experiment and compare its performance with the existing scheme TeamPhone. The simulation results show that the proposed approach can significantly reduce the schedule vacancy of broadcasting distress signal and improve the discovery probability with very little sacrifice of network lifetime, and indicate a potentially viable approach to expedite disaster rescue and relief operations. The study done by [3] observed that efficiency of emergency responses is at the heart of post-disaster rescue routing problems. Previous rescue models address the efficiency issue primarily by minimizing the total travel time, while not taking into account other significant factors in the rescue process, such as the number of affected people and the degree of building damage. To overcome these shortcomings, this paper aims to solve the rescue routing problem by maximizing the arc-based rescue efficiency, which is redefined as the ratio between the primary rescue input and output factors to represent the efficiency of the rescue operations. Therefore, a

systematic methodology is proposed to decompose the original rescue routing problem into two decision making phases. First, an extended data envelopment analysis (DEA) model is constructed to evaluate the rescue efficiency along each arc. Specifically, a group decision constraint cone, which refers to the combined output of a group decision from experts, is constructed to distinguish the features and rescue focus of each disaster. Second, an efficiency-based routing model is developed to determine a feasible rescue tour for the entire transportation network, thus achieving the goal of maximizing the total rescue efficiency. An empirical example of a real earthquake disaster in Wenchuan, China, is provided to demonstrate the novelty and practical capabilities of the proposed approach in post-disaster emergency rescue operations. Finally, a comparison analysis is conducted with the traditional time-oriented routing method, and the results show that the method proposed in this study can improve the rescue performance by 21.2%. The study done by [4] in the field of cloud based disaster management system states the combination of wireless sensor networks (WSNs) and 3D virtual environments opens a new paradigm for their use in natural disaster management applications. It is important to have a realistic virtual environment based on datasets received from WSNs to prepare a backup rescue scenario with an acceptable response time. This paper describes a complete cloud-based system that collects data from wireless sensor nodes deployed in real environments and then builds a 3D environment in near real-time to reflect the incident detected by sensors (fire, gas leaking, etc.). The system's purpose is to be used as a training environment for a rescue team to develop various rescue plans before they are applied in real emergency situations. The proposed cloud architecture combines 3D data streaming and sensor data collection to build an efficient network infrastructure that meets the strict network latency requirements for 3D mobile disaster applications. As compared to other existing systems, the proposed system is truly complete. First, it collects data from sensor nodes and then transfers it using an enhanced Routing Protocol for Low-Power and Lossy Networks (RLP). A 3D modular visualizer with a dynamic game engine was also developed in the cloud for near-real time 3D rendering. This is an advantage for highly-complex rendering algorithms and less powerful



devices. An Extensible Markup Language (XML) atomic action concept was used to inject 3D scene modifications into the game engine without stopping or restarting the engine. Finally, a multi-objective multiple traveling salesman problem (AHP-MTSP) algorithm is proposed to generate an efficient rescue plan by assigning robots and multiple unmanned aerial vehicles to disaster target locations, while minimizing a set of predefined objectives that depend on the situation. The results demonstrate that immediate feedback obtained from the reconstructed 3D environment can help to investigate what-if scenarios, allowing for the preparation of effective rescue plans with an appropriate management effort. Also the literature study in field of applications of latest technologies for disaster management as [5] figured that Disaster management is an urgent requirement around the world. The management in disasters include awareness, real-time forecasting, monitoring, managing, emergency service and after effects. Now-a-days various technologies have developed and tried in the field of natural hazards. For real-time information, remote sensing plays an essential role. Remote sensing is technology that acquires remotely sensed data without physical contact with the target on the Earth surface. The remote sensing technology works on the various types of sensors mounted on satellites that sensed remote data from far away. The active remote sensing has its own illuminating source as well as sun as energy for sensing the data whereas the passive remote sensing satellite utilizes the sun as an energy source for acquiring data. And the Internet of Things (IoT) technology provides internet as a medium for quick data transferring in real-time. The objective of the paper is to study various technologies for providing real-time information in disaster management. Further the other latest technologies such as Geographical Information System (GIS), Artificial Intelligence (AI), Drones, Information and Communication Technologies (ICT) etc have developed in the field of disaster monitoring that has increased the safety three- four times. The recent study [6] observed disaster management is a critical area that requires efficient methods and techniques to address various challenges. This comprehensive assessment offers an in-depth overview of disaster management systems, methods, obstacles, and potential future paths.

Specifically, it focuses on flood control, a significant and recurrent category of natural disasters. The analysis begins by exploring various types of natural catastrophes, including earthquakes, wildfires, and floods. It then delves into the different domains that collectively contribute to effective flood management. These domains encompass cutting-edge technologies such as big data analysis and cloud computing, providing scalable and reliable infrastructure for data storage, processing, and analysis. The study investigates the potential of the Internet of Things and sensor networks to gather real-time data from flood-prone areas, enhancing situational awareness and enabling prompt actions. Model-driven engineering is examined for its utility in developing and modeling flood scenarios, aiding in preparation and response planning. This study includes the Google Earth engine (GEE) and examines previous studies involving GEE. Moreover, we discuss remote sensing; remote sensing is undoubtedly a valuable tool for disaster management, and offers geographical data in various situations. We explore the application of Geographical Information System (GIS) and Spatial Data Management for visualizing and analyzing spatial data and facilitating informed decision-making and resource allocation during floods. In the final section, the focus shifts to the utilization of machine learning and data analytics in flood management. These methodologies offer predictive models and data-driven insights, enhancing early warning systems, risk assessment, and mitigation strategies. Through this in-depth analysis, the significance of incorporating these spheres into flood control procedures is highlighted, with the aim of improving disaster management techniques and enhancing resilience in flood-prone regions. The paper addresses existing challenges and provides future research directions, ultimately striving for a clearer and more coherent representation of disaster management techniques.

## METHODOLOGY

Our work we have designed to revolutionize emergency response and disaster management. Within this framework, the project is dissected into three distinctive modules, each catering to specific aspects of the overarching goal.

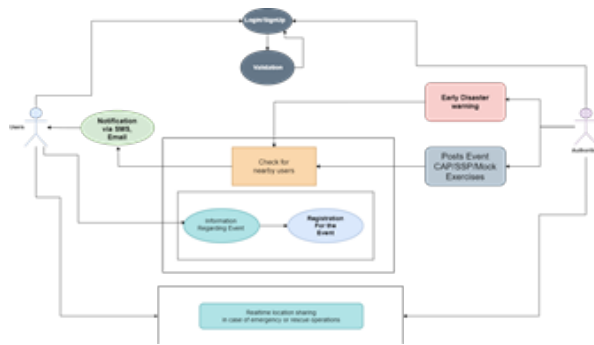

Figure 1. System Architecture

- A. Realtime-Location sharing module- The first module intricately focuses on real-time location sharing, constituting a critical feature for users to relay their exact locations during emergencies. Simultaneously, rescue agencies can leverage the system to coordinate operations efficiently by sharing their real-time locations. The implementation relies on a powerful technology stack, including Node.js, Express.js, Socket.IO, and MongoDB with GeoJSON functionality. This combination facilitates the seamless fetching and transmission of real-time locations, ensuring precision and responsiveness during rescue operations.
- B. Alerts module - In the second module, the research delves into the intricacies of an alert system designed to notify users situated within a predefined range of alerting locations during disaster scenarios. This involves the integration of Twilio for SMS alerts and Nodemailer for email alerts within the Node.js environment. Notably, client-side interaction is facilitated through the incorporation of OpenStreetMap in Flutter, empowering users to select alert locations dynamically. Agencies play a pivotal role in this module, registering on the platform to issue alerts with specified severity levels, dates, and additional contextual information. The result is a robust and versatile alert system capable of rapidly disseminating critical information to users in times of need.
- C. Events module - The third module, equally pivotal in the comprehensive emergency response platform, revolves around organizing awareness events, mock drills, and safety programs. Leveraging

the capabilities of Node.js for REST APIs and MongoDB for event details, the module stands out as a cost-effective and efficient solution for agencies to disseminate information about upcoming events. Users residing within a 10km radius of event locations receive targeted SMS and email notifications, fostering proactive engagement. The system further streamlines the user experience by allowing event registration directly within the app, providing agencies with valuable insights into user interest and facilitating effective event planning.

### COMPARATIVE RESULTS AND DISCUSSION

This review delves into various studies presenting an array of features intended for the enhancement of Disaster and Rescue management. These functionalities are strategically crafted to elevate public awareness, expedite responsiveness during emergencies, deliver timely alerts for anticipated disasters, and empower users to not only view but also share their locations with the relevant authorities. The system commences with distinct applications catering to the registration and login processes for both agencies and users, thereby establishing a clear distinction between the access privileges of authorities and general users.



Figure 2. Agency Screen- Home Screen

Present on the agency home screen are three primary modules, including the Real-time Location Sharing module, the Alert module, and the Event module. Additionally, the screen incorporates several auxiliary components, such as the capability to manage events and access the rescue map. This comprehensive layout provides a user-friendly interface, facilitating seamless navigation and utilization of the various features and functionalities embedded within the system.

**Start Rescue Operation**

**OPERATION LOCATION**

**RESCUE OPERATION NAME**

**RESCUE TEAM SIZE**

**DESCRIPTION**

**START OPERATION**

**Figure 3. Agency Screen- Rescue Operation**

The first module of our disaster and rescue management system focuses on real-time location sharing. This feature enables users in distress or facing disasters to share their real-time location with nearby agencies within a specified range. Simultaneously, agencies can share their real-time location with nearby users and other agencies to enhance coordination during rescue operations. To implement this, we leverage Node.js, Express.js, Socket.IO, and MongoDB's GEO JSON functionality. This combination allows us to efficiently fetch nearby users and agencies, facilitating the seamless transmission of location information.

9:41  
 Jai Hind! NDRF Team REX78

**Send Emergency Alert**

**ALERTING AREA**

**ALERT NAME**

**ALERT SEVERITY**

**DATE**

**SEND ALERT**

**Figure 4. Agency Screen- Send Emergency Alert**

The second module is dedicated to sending alerts to users within the designated alerting locations. Utilizing Twilio message service in Node.js and Nodemailer for SMS and email notifications, our system ensures timely communication with users residing within a 10 km range of alert locations on the map. OpenStreetMap in Flutter is employed for selecting alerting locations on the client side. Agencies registered on our platform can issue alerts, specifying severity, date, and additional information. Users entering alert-prone areas receive immediate notifications, enhancing situational awareness and response.

The third module revolves around organizing awareness events, mock drills, safety programs, and other SSP programs. Our platform provides agencies with a cost-effective and efficient means to spread information about such events. Traditionally, relying on TV ads, posters, and pamphlet distribution can be expensive and less effective. Leveraging Node.js for REST APIs and MongoDB for data storage, our system ensures seamless processing. When an agency adds an event, SMS and email notifications are sent to users residing within a 10 km radius of the event location. This targeted approach not only enhances event participation but also

allows agencies to efficiently organize and manage these programs based on user interest and registrations.

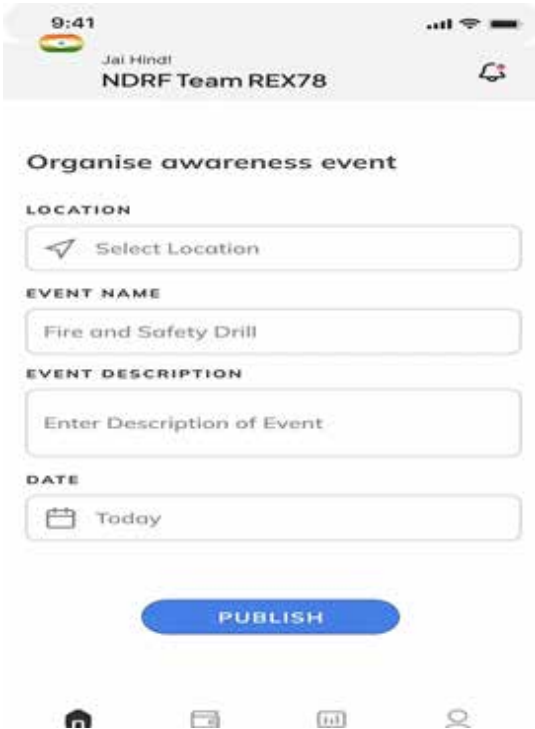

Figure 5. Agency Screen- Organize Awareness Event



Figure 6. User Screen- Home Screen

Upon logging in or completing the registration process, users are directed to the home screen, where four primary features await their attention. The first feature entails exploring nearby programs and events, providing users with a comprehensive overview of local activities. The second feature focuses on received alerts, ensuring users stay informed about critical updates. The third feature highlights nearby agencies involved in ongoing rescue operations, promoting real-time awareness and coordination. Finally, the fourth feature allows users to efficiently search for details pertaining to specific agencies.

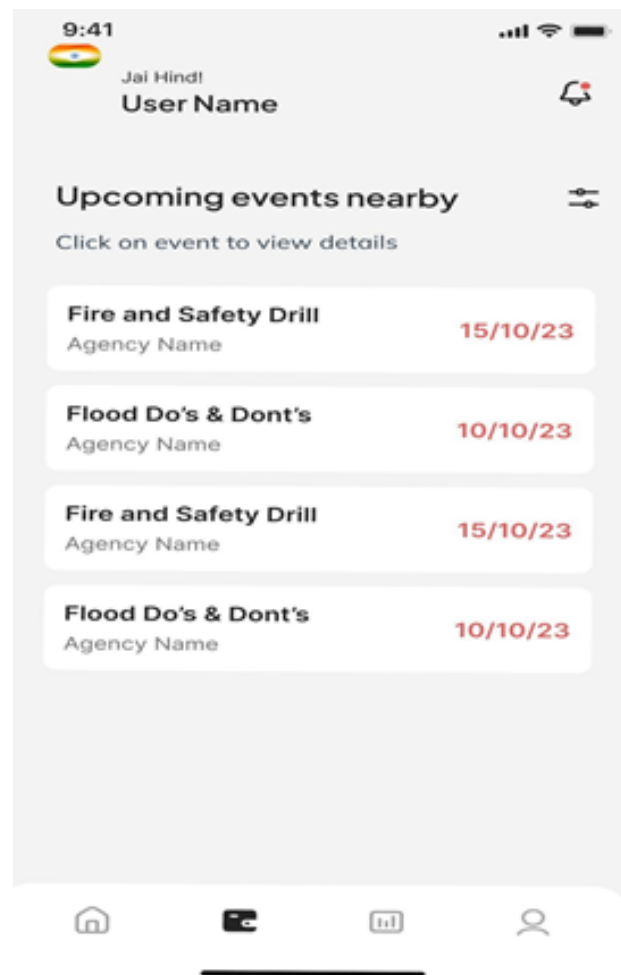

Figure 7. User Screen- Programs and Events

In this first Programs and Events feature, users can seamlessly explore both nearby and upcoming events. By selecting a specific event, users can delve into its detailed history and gain comprehensive insights.

Furthermore, this interactive platform enables users to register for events directly, enhancing user engagement and participation.

In this second Alerts feature, the second module of our comprehensive system, users are dynamically notified of critical alerts with thorough information. These details encompass specifics like the type of alerts, the date of the unfolding disaster, and a categorization of severity into high, medium, or low. To ensure heightened user awareness, these alerts are not only visually represented with associated locations within the feature but are also dispatched as notifications to both the user's email and mobile devices. This multi-channel alert system provides users with an extensive and timely understanding of the evolving situations, fostering a proactive and informed response.

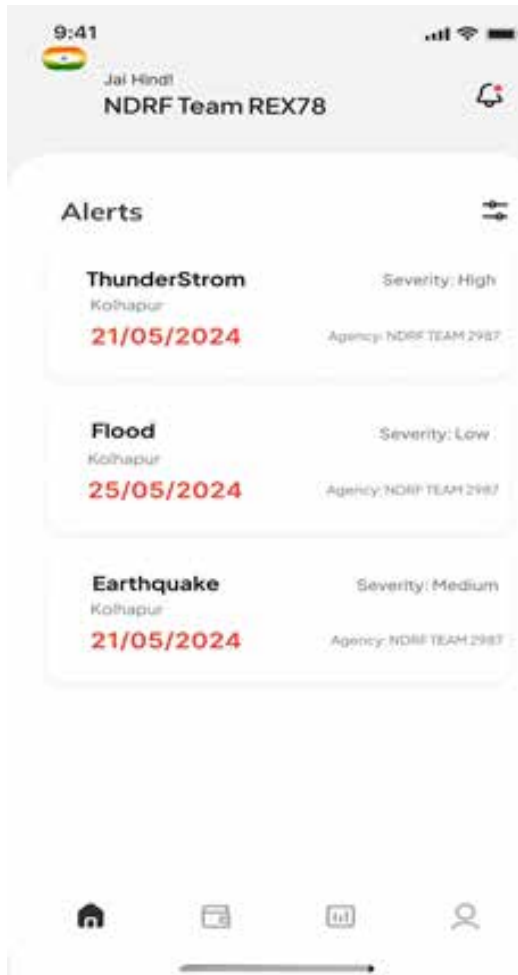

Figure 8. User Screen- Alert

## CONCLUSION

In conclusion, our work stands as a robust solution catering to critical gaps in disaster preparedness and response. By offering features like sending alerts, organizing safety events, and a rescue mechanism capable of sharing user locations with nearby agencies within a 10 km radius, our work significantly enhances emergency response capabilities. Moreover, during disaster scenarios like floods, earthquakes, or landslides, the work empowers rescue agencies to initiate operations, share real-time location data, and coordinate effectively, minimizing communication gaps and errors. Leveraging Node.js, Express.js for REST APIs, Socket.io for real-time location sharing, and MongoDB's GeoJSON APIs, our platform ensures efficient and effective response mechanisms.

However, challenges persist, notably in disrupted communication lines during disasters. Yet, with the promising advent of Starlink satellite internet by Elon Musk, offering global connectivity via satellite, we foresee potential solutions to mitigate this limitation, ensuring continuous communication and support during crises. Furthermore, while presently designed in English, the vast diversity of languages in India beckons the need to localize our app for broader accessibility. Introducing support for local languages will facilitate a more inclusive and user-friendly experience, aiding individuals across diverse linguistic backgrounds during emergencies. Moreover, considering historical disaster data and leveraging Machine Learning (ML), we envision the ability to predict and identify areas prone to disasters. This proactive approach allows for better preparedness, resource allocation, and timely interventions, ultimately reducing the impact and severity of disasters.

In essence, our work represents a significant stride toward revolutionizing disaster management by leveraging technology, real-time communication, and predictive analytics. The continuous evolution and adaptation of our app, including satellite-based internet, language localization, and predictive analysis, demonstrate our commitment to enhancing global emergency response systems and ultimately, saving lives.



**REFERENCES**

1. Mahajan, Madhura, K. T. V. Reddy, and Manita Rajput. "Design and implementation of a rescue system for safety of women." In 2016 international conference on wireless communications, signal processing and networking (WiSPNET), pp. 1955-1959. IEEE, 2016.
2. Pu, Cong, and Xitong Zhou. "RescueMe: Smartphone-based self rescue system for disaster rescue." In 2019 IEEE 9th Annual Computing and Communication Workshop and Conference (CCWC), pp. 0832-0837. IEEE, 2019.
3. Liu, Bingsheng, Jiuh-Biing Sheu, Xue Zhao, Yuan Chen, and Wei Zhang. "Decision making on post-disaster rescue routing problems from the rescue efficiency perspective." *European Journal of Operational Research* 286, no. 1 (2020): 321-335.
4. Cheikhrouhou, Omar, Anis Koubâa, and Anis Zarrad. "A cloud based disaster management system." *Journal of Sensor and Actuator Networks* 9, no. 1 (2020): 6.
5. Applications of latest technologies for disaster management: A literature review (2021) by Chourushi.
6. Disaster Management Software: A Review of Current Trends and Future Directions (2019) by Pradhan et al.
7. The Use of Decision Support in Search and Rescue: A Systematic Literature Review (2023) by Liu et al.
8. Multifidelity prediction in wildfire spread simulation: Modeling, uncertainty quantification and sensitivity analysis. *Environ. Model. Softw.* (2021) by Valero, M.M.; Jofre, L.; Torres, R.
9. Comparison of Earthquake Environmental Effects and ESI intensities for recent seismic events in different tectonic settings: Sichuan (SW China) and Central Apennines (Italy). *Eng. Geol.* by Huayong, N.; Hua, G.; Yanchao, G.; Blumetti, A.M.; Comerci, V.; Di Manna, P.; Guerrieri, L.; Vittori, E.
10. Space-Air-Ground Integrated Network for Disaster Management: Systematic Literature Review (2023) by Alharbi et al.
11. Khan, Saad Mazhar, Imran Shafi, Wasi Haider Butt, Isabel de la Torre Diez, Miguel Angel López Flores, Juan Castanedo Galán, and Imran Ashraf. "A Systematic Review of Disaster Management Systems: Approaches, Challenges, and Future Directions." *Land* 12, no. 8 (2023): 1514.

# Travel Advisor Using Web Technology

**Nilesh Hupare, Prasad Magar  
Mahesh Mohite, Afrid Pathan**

Department of Computer Science & Engineering  
Dr. D.Y.Patil Pratisthan's College of Engineering  
Salokhenagar, Kolhapur, Maharashtra

✉ Nileshhupare20@gmail.com

✉ prasadmagar1211@gmail.com

✉ maheshmohite6520@gmail.com

✉ afridpathan1908@gmail.com

**Ganesh Rathod**

Assistant Professor

Department of Computer Science & Engineering  
Dr. D.Y.Patil Pratisthan's College of Engineering  
Salokhenagar, Kolhapur, Maharashtra

✉ ganeshrthd883@gmail.com

## ABSTRACT

The travel industry is undergoing a transformative shift driven by advancements in technology and changing consumer preferences. In this context, the "Travel Advisor" project aims to create a user-centric, intelligent travel recommendation system that leverages artificial intelligence and machine learning algorithms to provide personalized travel suggestions and guidance. This project focuses on improving the overall travel experience for individuals seeking to plan their trips. By aggregating and analyzing vast amounts of travel-related data, including destination information, user preferences, budget constraints, and realtime travel updates, the Travel Advisor system aims to offer tailored recommendations for accommodation, activities, and itineraries.

**KEYWORDS:** *Geolocation Services, API Integrations, advisory services, ensuring traveler safety, User Experience (UX) Design, Real-time Alerts, Destination Safety, Tourism Resilience, Travel Restrictions, Virtual Reality (VR).*

## INTRODUCTION

The modern travel landscape is evolving at an unprecedented pace, driven by the confluence of technology and changing consumer expectations. As travellers increasingly seek unique, personalized experiences, the traditional one-size-fits-all approach to travel planning is being replaced by a demand for tailored, intelligent solutions. In response to this shift, the "Travel Advisor" project emerges as a visionary solution poised to revolutionize the way individuals plan and experience their journeys. This project is grounded in the understanding that travel is not just about reaching a destination, but an intricate tapestry of experiences and choices. It seeks to harness the potential of artificial intelligence and data analytics to create a Travel Advisor system that caters to the unique preferences, constraints, and aspirations of each traveler. By leveraging a wealth of data sources, from travel websites and user reviews to weather forecasts and real-time updates, the Travel Advisor aims to become a trusted companion in the

traveller's journey. Key goals of this project encompass the integration and analysis of diverse travel related data, the development of individualized user profiles, the creation of a sophisticated recommendation engine, and the provision of real-time updates. Furthermore, it places a strong emphasis on user feedback and iteration, recognizing that the travel experience is a dynamic, ever-evolving process.

## LITERATURE REVIEW

[1]. "The Role of Travel Agents in the Distribution of Travel Products" - Buhalis D. (1998) Buhalis' study from 1998 explores the role of travel agents in the distribution of travel products. This work predates the widespread adoption of online travel reviews and social media platforms. Nevertheless, it lays the foundation for understanding the traditional travel industry's structure and the intermediary role of travel agents in connecting travellers with products and services. It serves as an important background piece for understanding the evolution of the travel industry.

- [2]. "An Analysis of the Impact of Online Travel Reviews on Traveller Behavior" - Xiang Z., Du Q., Ma Y., Fan W. (2017) The 2017 study by Xiang et al. investigates the influence of online travel reviews on traveller behavior. It is a contemporary piece that delves into the digital era, focusing on the impact of user-generated content, such as online reviews, on travel choices and behavior. This research explores how traveller's decisions are affected by the information and feedback they encounter on various online platforms, emphasizing the role of user-generated content and its influence on the travel industry.
- [3]. "The Impact of User-Generated Content on Travel Decision Making" - Sparks, B., & Browning, V. (2011) Sparks and Browning's 2011 research contributes to the understanding of the role of user-generated content in travel decision making. It discusses how online reviews, blogs, and social media platforms impact traveler's choices, providing insights into the mechanisms through which such content influences behavior. This work offers valuable insights into the dynamics of online travel reviews and their influence on traveller's behavior. [4]. "Travel Risk and Destination Analysis"-Frameworks for assessing travel risks (political instability, natural disasters, health concerns) Tourist vulnerability and safety considerations Destination analysis methods considering safety and security factors. [5]. "Information Dissemination and User Needs"- User preferences for travel information and risk communication. Effectiveness of different communication channels for travel advisories (e.g., mobile apps, social media) Personalization of travel advisories based on traveler profiles and itineraries. [6]. "Existing Travel Advisory Systems"-- Analysis of prominent travel advisory resources (e.g., government advisories, travel blogs) Strengths and weaknesses of current travel information dissemination methods. Case studies of successful travel advisory systems and their impact on traveler behaviour. [7]. "Technological Advancements in Travel Advisories"-- Role of real-time data and AI in travel risk assessment. Integration of travel advisories with mobile apps and travel booking platforms. Potential of chatbots and virtual assistants for personalized travel risk communication. [8]. The psychological impact of travel advisories on tourist decision-making. [9]. Balancing risk information with destination promotion in travel advisories. [10]. Ethical considerations in travel advisories, such as cultural sensitivity and data privacy. [11]. Overview of different types of travel advisories (e.g., health, safety, security) Factors Influencing Travel Advisories. [12]. Analysis of factors (e.g., political instability, health risks, natural disasters) that lead to travel advisories. [13]. Impact on Tourism-- Literature on how travel advisories affect tourism industry, including economic impacts. [14]. Risk Perception and Communication--Studies on how travelers perceive risks and how advisories influence decision-making. [15]. Government Policies and Responses-- Review of government policies and approaches to issuing and managing travel advisories. [16]. Role of Technology-- Exploration of how technology (e.g., apps, social media) is used in disseminating and responding to advisories. [17]. "The Impact of User-Generated Content on Travel Decision Making"-Sparks,B., and Browning,V.(2011) 2.4.[https://www.researchgate.net/publication/330410643\\_Intelligent\\_Travel\\_Advisor\\_System\\_ITADisease\\_Management](https://www.researchgate.net/publication/330410643_Intelligent_Travel_Advisor_System_ITADisease_Management) by R. K. Jainetal. 2019.
- [18] APEC (2003). APEC Tourism Impediments. Study Stage 1. TWG 04/2001. Final Repory. Dain Simpson Associates, Sydney, Australia, February.
- [19] APEC Tourism Working Group (2004). APEC Tourism Impediments Study. Stage 2. Final Report. (TWG/01/2004). Prepared for APEC Tourism Working Group Prepared by The Conference Board of Canada, Ottawa, Canada.
- [20] B. and Cooper, C. (Eds) (2005). Worldwide destinations; The geography of travel and tourism, (fourth edition), Elsevier Butterworth-Heinemann, Italy, pp.476-488.

## METHODOLOGY

Our work we have designed to revolutionize Travel experience of the users. Within this framework, the project is dissected into three distinctive modules, each catering to specific aspects of the overarching goal.

**A. Realtime-Location search module-** The location search module on a travel advisor website allows users to find information and recommendations about various destinations worldwide. This module typically includes a search bar where users can enter a specific location or

browse through popular destinations. The search results provide details such as attractions, accommodations, restaurants, weather information, local transportation options, and travel tips. Users can refine their search based on interests (e.g., beach holidays, adventure travel, cultural experiences) and access curated content like articles, reviews, and traveler insights for each location. The location search module aims to assist users in researching and planning their trips by offering comprehensive and reliable destination information in a user-friendly format.

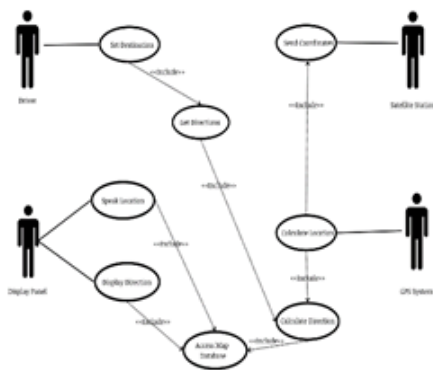

Figure 1. System Architecture

**B. Login/Signup module -**

Implementing a login/signup module for a travel advisor website involves creating a secure authentication system that allows users to register for new accounts or log in with existing credentials. This module typically includes a user interface for entering email addresses or usernames and passwords. The backend of the module manages user sessions, securely stores and retrieves user credentials, and handles password encryption to ensure data privacy. Additionally, features like password reset functionalities via email verification and captcha mechanisms can enhance security. Once logged in, users can access personalized travel recommendations, save preferences, review bookings, and engage with interactive travel content. The login/signup module plays a crucial role in providing a seamless and secure user experience on the travel advisor website.

**C. Dashboard module -** The dashboard module of a travel advisor website serves as a centralized hub where users can access a range of features and tools to enhance

their travel planning experience. This module typically includes personalized recommendations based on user preferences and past bookings, allowing travelers to discover new destinations, accommodations, and activities. Users can manage their bookings, view itineraries, and make modifications or cancellations as needed. The dashboard also provides access to saved favorites, such as favorite destinations, hotels, or tours, making it easy for users to revisit and book these options quickly. Additionally, the module may include features like notifications for travel alerts, reminders for upcoming trips, and access to customer support or travel assistance. Overall, the dashboard module of a travel advisor website aims to streamline the travel planning process and provide a seamless and personalized experience for users.

**COMPARATIVE RESULTS AND DISCUSSION**

The Travel Advisor web app is a comprehensive travel planning tool that caters to the needs of travelers seeking detailed destination information and seamless trip organization. This platform offers a wealth of features designed to streamline the travel planning process. Users can access extensive destination guides, including insights into attractions, local culture, and practical tips. The app's trip planning tools empower users to create personalized itineraries based on their preferences, budget, and desired activities.



Figure 2. Dashboard



The dashboard of a travel advisor web app comprises essential sections for user engagement and navigation. The home page welcomes users with search functionalities for destinations, flights, and accommodations, alongside featured travel deals. The about section offers insights into the service's mission and offerings, while the contact page provides means to reach the team for inquiries. The login/signup features enable account creation and access to personalized services. Lastly, the features section showcases booking tools for flights, hotels, and activities, travel guides, personalized profiles for saving preferences, and notifications for updates. Together, these sections create a user-friendly hub where travelers can explore, plan, and manage their trips efficiently.



Figure 3. Login/SignUp

The login/signup page for a travel advisor project should feature robust user authentication with separate forms for logging in and signing up, including fields for username/email and password for login, and additional fields like username, email, and password for signup. Consider integrating social login options (e.g., Google, Facebook) for convenience. Implement thorough validation and error handling to ensure input accuracy and meaningful error messages for users.

Include secure password management practices such as password hashing and a password reset mechanism via email or security questions. Manage sessions securely using tokens or cookies, and provide a logout option. Implement essential security measures against common vulnerabilities like SQL injection and XSS, and ensure data transmission security with HTTPS. Lastly, ensure responsive design for compatibility across various devices.

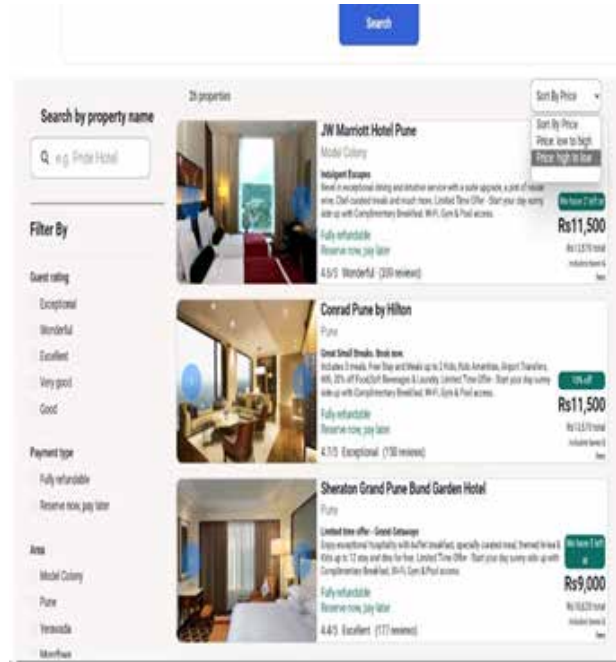

Figure 4. Search Functionality

Implementing a search functionality for a travel website involves creating a user-friendly interface where visitors can input travel preferences such as destination, dates, budget, and accommodation type. The system must then efficiently query a database containing details of available flights, hotels, rental cars, and activities based on the user's inputs. The search algorithm should consider various parameters like price, location, availability, and user ratings to deliver relevant results quickly. Additionally, incorporating features like auto complete, filters, and sorting options can enhance the user experience, allowing travelers to find and book their ideal itinerary seamlessly. Efficient indexing and caching of search results can optimize performance and ensure that users receive accurate and up-to-date information for planning their trips.



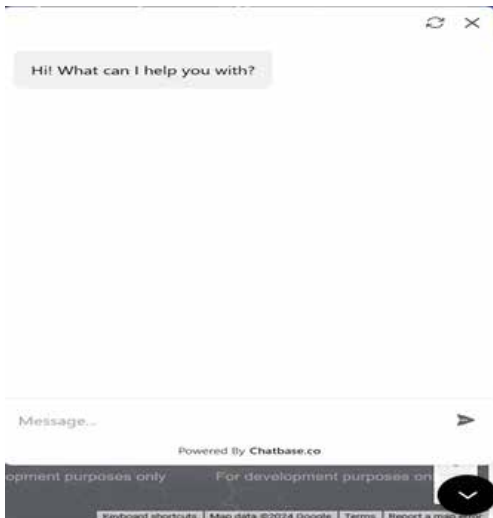

Figure 5. ChatBot

The travel advisor chatbot project utilizes natural language processing (NLP) and machine learning to provide personalized travel recommendations and assistance. This chatbot interacts with users, asking questions about their preferences such as destination type, budget, and travel dates, and uses this information to suggest suitable travel destinations, accommodations, and activities. It can handle queries about flights, hotels, attractions, and local transportation options, providing real-time information and recommendations based on user input. The chatbot is designed to continuously learn from user interactions to improve the accuracy and relevance of its responses, creating a tailored travel advisory experience for each user..

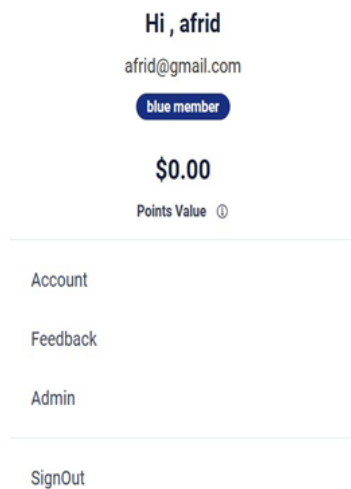

Figure 6. User Screen

After logging in successfully to a travel website, users gain access to personalized account features tailored to enhance their travel experience. These features typically include the ability to manage bookings, view past and upcoming trips, save favorite destinations or itineraries, update personal information, and receive notifications about exclusive deals or promotions based on their travel preferences. Additionally, logged-in users can often access loyalty programs, earn rewards points, and benefit from member-only discounts. The user account dashboard provides a centralized hub for managing all aspects of travel planning and booking, ensuring a convenient and customized experience for frequent and returning visitors.

### CONCLUSION

The completed login and signup modules of the travel advisor system establish a secure and user-friendly entry point for users to access their accounts and create new ones, with robust authentication and data collection processes. Meanwhile, the dashboard module serves as a personalized central hub where users can efficiently manage their travel plans, access quick links to system features, receive notifications, and engage with relevant travel recommendations and information, enhancing the overall user experience and facilitating effective travel planning and interaction with the platform.

### REFERENCES

1. D. Aha and L. Breslow. Refining conversational case libraries. In Case-Based Reasoning Research and Development, Proceedings of the 2nd International Conference on Case-Based Reasoning (ICCBR-97), pages 267–278. Springer, 1997.
2. P. K. Ankomah, J. L. Crompton, and D. Baker. Influence of cognitive distance in vacation choice. *Annals of Tourism Research*, 23(1):138–150, 1996.
3. R. Burke. Knowledge-based recommender systems. In J. E. Daily, A. Kent, and H. Lancour, editors, *Encyclopedia of Library and Information Science*, volume 69. Marcel Dekker, 2000.
4. J. J. Daniels and E. L. Rissland. What you saw is what you want: Using cases to seed information retrieval. In ICCBR, pages 325–336, 1997.
5. J. Delgado and R. Davidson. Knowledge bases and user profiling in travel and hospitality recommender systems.

- In Proceedings of the ENTER 2002 Conference, pages 1–16, Innsbruck, Austria, January 22–25 2002. Springer Verlag.
6. D. R. Fesenmaier and J. Jeng. Assessing structure in the pleasure trip planning process. *Tourism Analysis*, 5:13–17, 2000.
  7. D. Florescu, A. Levy, and A. Mendelzon. Database techniques for the world-wide web: a survey. *SIGMOD Record*, 27(3):59–74, 1998.
  8. T. Gaasterland, P. Godfrey, and J. Minker. An overview of cooperative answering. *Journal of Intelligent Information Systems*, 1(2):123–157, 1992.
  9. M. H. Göker and C. A. Thomson. Personalized conversational case-based recommendation. In *Advances in case-based reasoning: 5th European workshop, EWCBR-2000, Trento, Italy, September 6-9, 2000: proceedings*, pages 99–111. Springer, 2000.
  10. K. Grabler and A. Zins. Vacation trip decision styles as basis for an automated recommendation system: Lessons from observational studies. In *Proceedings of the ENTER 2002 Conference, Innsbruck, Austria, January 22–25 2002*. Springer Verlag.
  11. Y.-H. Hwang, U. Gretzel, and D. R. Fesenmaier. Behavioral foundations for human-centric travel decision-aid systems. In *Proceedings of the ENTER 2002 Conference, Innsbruck, Austria, January 22–25 2002*. Springer Verlag.
  12. N. Kassem and the Enterprise Team. *Designing Enterprise Applications with the Java™ 2 Platform, Enterprise Edition*. Addison-Wesley, 2000.
  13. M. Lenz. Imtas-intelligent multimedia travel agent system. In *Information and Communication Technologies in Tourism (Proceedings of ENTER-96)*, pages 11–17. Springer, 1996.
  14. L. Moutinho. Consumer behavior in tourism. *European Journal of Marketing*, 21:2–44, 1987.
  15. F. Ricci, N. Mirzadeh, A. Venturini, and H. Werthner. Case-based reasoning and legacy data reuse for web-based recommendation architectures. In *Proceedings of the Third International Conference on Information Integration and Web-based Applications & Services*, pages 229–241, Linz, Austria, September 10-12 2001.
  16. B. Sarwar, G. Karypis, J. Konstan, and J. Riedl. Item-based collaborative filtering recommendation algorithms. In *Proceedings of WWW10 Conference*, pages 285–295, Hong Kong, May 1–5 2001. ACM.
  17. B. Smyth and M. T. Keane. Design a la deja vu: Reducing the adaptation overhead. In *Case-Based Reasoning: Experiences, Lessons, and Future Directions*. AAAI Press/MIT Press, 1996.
  18. A. Stahl and R. Bergman. Applying recursive cbr for the customization of structured products in an electronic shop. In *Advances in case-based reasoning: 5th European workshop, EWCBR-2000, Trento, Italy, September 6-9, 2000: proceedings*, pages 297–308. Springer, 2000.
  19. G. Wiederhold. Mediators in the architecture of future information systems. *IEEE Computer*, 25(3):38–49, 1992.
  20. D. R. Wilson and T. R. Martinez. Improved heterogeneous distance functions. *Journal of Artificial Intelligence Research*, 11:1–34, 1997.

# Articulation of Artificial Intelligence in Judiciary System: Navigating Fifth Industrial Age

**Utkarsh Subhashchandra Patankar**

LLB- III Student  
Shahaji Law College  
Kolhapur, Maharashtra

**M. C. Sheikh**

Professor  
Shahaji Law College  
Kolhapur, Maharashtra

## ABSTRACT

The use of Artificial Intelligence in numerous domains has led to the development of legislation that address the technology. Judicial Attorneys have largely been interested in the intellectual discussion of AI for the judicial application of the law. Some countries, however, use AI- based IT systems in their legal systems. One may argue that incorporating AI into the legal system would bring about a conceptual and technical revolution. The potential of AI in the court system is being looked at by judiciaries, prosecution services, and other specialized judicial agencies on a global scale. To assist with investigations and automate the decision-making process, for instance, some judicial systems throughout the world have already embraced AI technology. These issues have gained more attention among attorneys as a result of the development of AI-based IT systems. Through the use of artificial intelligence (AI), computers may now be instructed to do activities that previously needed human intelligence. It includes a variety of technologies such as machine learning, pattern recognition, big data, neural networks, self-algorithms, and others. Giving a computer specific data and having it respond to numerous events are challenging challenges that come with AI. AI can help you finish a task in a couple of minutes.

**KEYWORDS** : *Artificial Intelligence, Judiciary, Machine learning, Law, Decision making.*

## INTRODUCTION

But what exactly do we mean by "Artificial Intelligence"? Artificial intelligence is defined as a "science and a set of computational technologies inspired by how people use their nervous system, body, senses, and how they learn, reason, and act Artificial intelligence (AI) in the form of Machine Learning (ML) enables software programmes to become more accurate at making predictions without needing to be explicitly programmed to do so. Machine learning algorithms use previous data as input to forecast new output values. What will judgement entail in the upcoming 10, 20, or 30 years in terms of these innovations and those related to AI? It is plainly obvious that the responsibilities of individuals involved in justice and judgement are changing quickly, and that certain areas of the judicial system have already been altered by newer, more disruptive technology. Around the world, courts,

prosecution services, and other domain-specific judicial authorities are investigating the application of AI in judicial systems. For instance, several legal systems throughout the world already deploy AI technologies to support investigation efforts and automate decision-making procedures in the realm of criminal justice. Given the field's rapid advancement, talks among judicial ecosystem stakeholders this paper emphasizes the potential and problems associated with utilising AI in judicial systems, as well as the consequences for human rights and the rule of law.

Concept: Technology is already reshaping the justice system in three major ways. First and foremost, technology is assisting in informing, supporting, and advising people involved in the justice system (supportive technology). Second, technology can replace functions and activities previously performed by humans (replacement technologies). Finally, at a third

level, technology can alter the way judges work and provide for very different forms of justice (disruptive technology), especially where processes change significantly and predictive analytics may reshape the adjudicative role. Issues concerning the impact of technology on the role and function of a judge in terms of the adjudicative function emerge at the second and third levels.

## A LAW CODE

Computer programmers and IT professionals are not rarely qualified or experienced in the law, nor are they policy or administrative experts. These professionals, however, are tasked with converting legislation and case law into computer codes and commands that will allow an autonomous process to make decisions. While these sources of law are complex on their own, they also work in conjunction with statutory presumptions and discretionary judgements. It is difficult to ensure that these complexities are properly coded into an autonomous process. Because of these difficulties, some commentators believe that more regulatory areas of the law may be better suited to transformation into computer code. Similarly, due to frequent amendments, new case decisions, and complex transitional provisions, these codes will need to be constantly updated.

Autonomous systems will also need the ability to apply the law from various points in time in order to ensure that cases are decided based on the laws that were in effect at the time the actions occurred. These challenges may be met by involving lawyers and policymakers in the development and upkeep of these computer programmes.

Semantics and Syntax: Similarly, the philosophical distinction between syntax and semantics may pose a challenge to the use of AI in law. Searle famously observed that while computer programmes have syntax (a formal structure of operation), they lack semantics (meaning behind these operations). Information is processed by digital technology in the form of abstract symbols known as ones and zeros. The technology can process and manipulate these symbols, but it does not comprehend the meaning behind these processes. In other words, the machine does not comprehend the data it is processing. This is in contrast to the human mind,

which can comprehend the information it processes. This means that computer programmes will be able to simulate human thought processes, but it will be some time before they can truly duplicate human thought processes. However, as the information required for human decision-making becomes more complex (that is, involves a number of complex data sources) humans may be forced to rely on AI to make decisions.

An AI Judge: In terms of more basic adjudicatory functions, it is clear that many judicial functions require human intelligence, and computer programmes have yet to be developed to replace these functions or interact with people with compassion, emotion, or agility. However, could technological advancements one day replace human judges in the courtroom with an AI programmed to preside over hearings and issue more complex judgements, and how might more affective technologies assist or support this work? Harvey uses the example of algorithms already present in legal databases to provide a simplified description of the process that an AI judge would be required to follow. These databases use natural language processing to aid in the discovery of relevant material based on keywords. An AI judge would be required to go beyond these databases, by condensing returned sources into a manageable and relevant sample, and then deploying tools to compare these sources of law to a current case and engage in analysis to determine the outcome. Harvey explains that this final step requires "the development of the necessary algorithms that could undertake the comparative and predictive analysis, together with a form of probability analysis to generate an outcome that would be useful and informative". However, Harvey's model retains a large amount of human judge decision-making.

## Discretionary Judgements

Many decisions in the legal system involve some element of discretion. Computer programmes are logic-based systems that process input data using pre-programmed algorithms to produce a predetermined result. Such rigidity may be incompatible with discretionary decision-making. Discretionary decisions may need to consider community values, the subjective characteristics of parties, and any other relevant surrounding circumstances.

This means that computer programmes will be able to simulate human thought processes. Besides these, following ethics will be followed by an AI Law System as:

1. **Fundamental rights:** The design and implementation of AI services and tools are in accordance with fundamental rights such as privacy, equal treatment, and a fair trial.
2. **The same treatment:** Avoid discrimination against individuals and groups of people. The COMPAS example above demonstrates that discrimination and unjustified distinctions between individuals and groups are a real risk. The data used by the algorithm could be the source of the problem, and the prejudice could also be embedded in the algorithm itself.
3. **Data protection:** When processing judicial decisions and data, certified sources and unalterable data should be used, along with multidisciplinary models designed in a secure technological environment.

## WORLD SCENARIO

The IBM Watson-powered robot 'ROSS,' which used a novel approach of mining data and identifying trends and patterns in the law to address research issues, was the first global player to try to apply AI for legal purposes. Surprisingly, it will be the back-end work for litigation and arbitration purposes, such as research, data storage and use, and so on, that will be most affected.

Certain global initiatives purging the use of AI in Judiciary include:

- o US: COMPAS (Correctional Offender Management Profiling for Alternative Sanctions).
- o UK: HART (Harm Assessment Risk Tool).
- o Russia: Giving legal advice, approving pensions.
- o Estonia: Robot judge for adjudicating small claims.
- o Malaysia: Supporting sentencing decisions.
- o Austria: Sophisticated document management.
- o Argentina/Colombia: Prometea (Identifying urgent cases within minutes).
- o Singapore: Transcribing court hearings in real-time.

At the design level, a set of functional requirements must be chosen and translated into software codes that establish causal or instrumental relationships between various components. A web-based form, for example, must be completed, digitally signed, and submitted to a certified electronic address. The computer procedure gives the user one of several practical interpretations of the law. The procedure simplifies the operational domain functionally is as below:

### Organise Information

Recognizing patterns in text documents and files can be useful when sorting large amounts of cases or in complex cases with a lot of information. Before the start of a court procedure, electronic information is investigated for discovery. The parties agree on the search terms and coding to be used. The judge evaluates and approves the agreement. This is a document investigation method accepted by courts in the United States and the United Kingdom. Manual file research is slower and less accurate than this method.

### Advisory

This advisory function can assist people in resolving more of their problems on their own, thereby avoiding disputes or court cases. If the advice is insufficient, assistance in finding a solution is also an option. Help in developing a solution that requires judicial review, such as a request or summons, can ensure that the judge's decision becomes more of a routine. This function is currently in use at the Civil Resolution Tribunal (CRT) in British Columbia, Canada. The CRT was established to resolve strata and subsidised housing disputes. After it proved as successful, the jurisdiction was gradually expanded, and personal injury resulting from collisions was added to its jurisdiction in April 2019. The Solution Explorer is provided by CRT with free public legal information and calculation aids available 24 hours a day, seven days a week.

### Predictions

A group of American academics has created a machine learning application that claims to be able to predict the outcome of a case at the United States Supreme Court (SCOTUS) with an accuracy of 70.2% and the voting behaviour of individual judges with an accuracy of 71.9%.<sup>10</sup> In addition to case information,



this application makes use of information about the individual justices' political preferences and voting history. The most extensively described application claims to be able to predict European Court of Human Rights decisions (ECHR). This tool employs natural language processing and machine learning to predict whether the Court will rule on whether a specific provision of the European Convention on Human Rights is applicable in a given situation. The material that this AI processes has already undergone numerous 'complexity reduction' steps. The majority of ECHR cases are handled by the registry, the Commission, or chambers with one or more judges. The investigators only used judgements from HUDOC, the European Court of Human Rights' online database, which does not include cases resulting from inadmissible requests.

The system must be protected from unanticipated, pre-established, or authorised external inputs and requests. As a result, technology implies functional closure (i.e., the construction of a protective cocoon placed around the selected causal sequences to ensure their recurrent unfolding). As a result of the closure, the system only accepts a pre-defined set of inputs, such as a fixed data set, a limit on the number of characters available to describe the case (in Money Claims on Line in England), and a limit on the size (MB) of the documents uploaded (e-justice platforms in Spain and Italy). The combination of functional simplification and closure enables system development and recurrent, stable, and reliable system unfolding.

An example from the courts in the United Kingdom demonstrates what can happen when IT is relied on blindly. In maintenance proceedings, a relatively simple piece of IT determines the financial capacity of (ex)-spouses. The parties complete a PDF form, and IT computes the resulting capacity. Incorrect calculations were made in 3,638 cases between April 2011 and January 2012, and between April 2014 and December 2015. This was due to a minor error that went unnoticed. Debts had been added to assets rather than deducted, so the assets taken into account were excessive. This could still be corrected in cases that were still pending. However, in over 2,200 cases, incorrect decisions were issued and presumably followed.

### Position in India

Recently, the Law Minister stated that in order to implement phase two of the eCourts project, new, cutting-edge technologies of Machine Learning (ML) and Artificial Intelligence (AI) must be used to increase the efficiency of the justice delivery system. In addition, the Supreme Court of India has formed an Artificial Intelligence Committee to investigate the use of AI in the judicial domain. The committee has identified applications for AI technology in judicial document translation, legal research assistance, and process automation.

What are some examples of how technology used in Indian Judiciary?

**E-courts Project:** It was designed to transform the Indian judiciary by providing courts with ICT (Information and Communication Technology). It is a pan-India project overseen and sponsored by the Ministry of Law and Justice and the Department of Justice for District Courts across the country. The objective was to provide timely and effective citizen-centric services.

**Virtual Hearing:** During the Covid-19 pandemic, the use of technology for e-filing and virtual hearings has increased dramatically.

**SUVAS** stands for Supreme Court Vidhik Anuvaad Software, is an artificial intelligence system that can aid in the translation of court decisions into regional languages. This is yet another historic effort to improve access to justice.

**SUPACE** stands for Supreme Court Portal for Court Efficiency. The Supreme Court of India recently launched it. It is intended to first understand judicial processes that require automation before assisting the Court in improving efficiency and reducing pendency by encapsulating judicial processes that can be automated through AI.

**ManCorp Innovations Lab (MCIL)**, an AI-powered solution company, investigated the difficulties faced by the Jharkhand High Court and discovered a lack of judges as well as a high volume of criminal cases. To address the issue, the company developed two technologies: optical character recognition (OCR) and

Chatbots. Whereas OCR converts scanned documents into computer-readable text, corrects orientation, and so on, ChatBot is controlled by both voice and text commands.

What exactly is the e-Courts Project?

It was created with the goal of transforming the Indian judiciary through the use of ICT (Information and Communication Technology) in the courts. It is a pan-India project overseen and funded by the Ministry of Law and Justice for District Courts throughout the country.

The project's goals are as follows:

- a. To deliver citizen-centric services in an efficient and timely manner.
- b. Creating, installing, and implementing decision support systems in courts.
- c. To automate processes in order to provide transparency and information accessibility to its stakeholders.
- d. To increase both qualitative and quantitative judicial productivity in order to make the justice delivery system more affordable, accessible, cost-effective, predictable, dependable, and transparent.

What is the Importance of Technology in the Judiciary?

According to the most recent National Judicial Data Grid (NJDG), 3,89,41,148 cases are pending at the District and Taluka levels, while 58,43,113 remain unresolved at the high courts. Pendency has a knock-on effect that reduces the efficiency of the judiciary and, as a result, people's access to justice.

### Conclusion

There have also been significant changes in the way courts operate. Tribunal and court systems are already utilising technology to provide support, intake, and advisory processes that are intended to assist disputants in negotiating more effectively without the involvement of court staff or other practitioners. Many courts will continue to build and expand online platforms and systems that support filing, referral, and other

activities in the near future. These modifications lay the groundwork for the development of Judge AI. Any shift toward Judge AI clearly raises many issues that have received little attention thus far.

Maintaining the Judge will always be different from other judges which may be counterproductive. As previously stated, many technology futurists believe that humans will not be completely replaced by AI. Instead, technological advances are likely to supplement human intelligence. This approach implies that judges may remain human but will be "augmented," that is, their intelligence and analytical functions will be supported by AI.

Thinking from an Indian perspective, prime concern is its affordability. Whether the System will be affordable or not? There are also some concerns about the nature of an AI's ethics. One point raised was that AI software does not have its own consciousness. While they think before acting, their behaviours are completely programmed, and there is always the question of trustworthiness because AI systems must have a clear ethical goal in addition to being technically strong and reliable. External regulation will be required by both the legislature and the judiciary in the form of statutes, rules, and regulations, as well as judicial review and constitutional norms.

References:

1. [https://www.researchgate.net/publication/341283034\\_Artificial\\_Intelligence\\_and\\_the\\_Transformation\\_of\\_Humans\\_Law\\_and\\_Technology\\_Interactions\\_in\\_Judicial\\_Proceedings](https://www.researchgate.net/publication/341283034_Artificial_Intelligence_and_the_Transformation_of_Humans_Law_and_Technology_Interactions_in_Judicial_Proceedings)
2. <https://www.scirp.org/journal/paperinformation.aspx?paperid=98503>
3. <https://vidhilegalpolicy.in/research/responsible-ai-for-the-indian-justice-system-a-strategy-paper/>
4. <https://iacajournal.org/articles/10.36745/ijca.343>
5. <https://www.unesco.org/en/artificial-intelligence/rule-law/mooc-judges#:~:text=Judicial%20systems%20worldwide%20are%20using,sentence%20duration%20and%20recidivism%20scores>
6. [https://www.judcom.nsw.gov.au/publications/benchbks/judicial\\_officers/judge\\_v\\_robot.html](https://www.judcom.nsw.gov.au/publications/benchbks/judicial_officers/judge_v_robot.html)

7. <https://www.thehindu.com/news/national/ai-ml-are-a-long-way-from-becoming-a-judicial-decision-making-tool/article65193656.ece>
8. [https://nja.gov.in/Concluded\\_Programmes/2021-22/P-1281\\_PPTs/2.Introduction%20of%20Artificial%20Intelligence%20in%20the%20Judicial%20System.pdf](https://nja.gov.in/Concluded_Programmes/2021-22/P-1281_PPTs/2.Introduction%20of%20Artificial%20Intelligence%20in%20the%20Judicial%20System.pdf)
9. <https://www.unodc.org/dohadeclaration/en/news/2020/12/it-and-ai-new-challenges-for-judiciaries.html>
10. <https://indiaai.gov.in/article/ai-in-judicial-systems>
11. <https://www.indiatimes.com/explainers/news/artificial-intelligence-and-indias-judicial-system-565113.html>
12. <https://pib.gov.in/PressReleaseIframePage.aspx?PRID=1814536>

# Digital Disruption: Transformative Trends and Impacts on Industry

## Suresh D. Mane

Dr. D. Y. Patil Prathisthan's College of Engineering  
Salokhenagar, Kolhapur, Maharashtra  
✉ mane.suresh@gmail.com

## Shivaleela Arlimatti

Department of Computer Science & Engineering  
Tatyasaheb Kore Institute of Engg. & Tech.  
Warananagar, Kolhapur, Maharashtra  
✉ sarlimatti@gmail.com

## Ganesh Rathod

Department of Computer Science & Engineering  
Dr. D.Y.Patil Pratisthan's College of Engineering  
Salokhenagar, Kolhapur, Maharashtra  
✉ ganeshrthd883@gmail.com

## ABSTRACT

Digital disruption is revolutionizing industries worldwide, driving innovation, efficiency, and the emergence of new business models. The paper presents a comprehensive review of the transformative trends and impacts of digital disruption across various sectors. It focuses on key enabling technologies such as 5G and advanced networks, artificial intelligence (AI), the Internet of Things (IoT), cloud computing, and blockchain technology. These technologies are reshaping industrial landscapes by enhancing connectivity, automating processes, facilitating real-time data exchange, providing scalable computing resources, and ensuring secure transactions. However, the adoption of these technologies poses significant challenges. Integrating digital technologies with legacy systems can be complex and disruptive to ongoing operations. Regulatory and compliance issues further complicate the landscape, as technological advancements often outpace existing frameworks. The paper concludes by highlighting future research directions. Addressing these multifaceted challenges is essential for industries to navigate digital disruption successfully and leverage its potential for sustainable growth and global competitiveness.

## INTRODUCTION

Digital disruption in industries is driven by several factors. Rapid advancements in technology, such as AI, machine learning (ML), big data analytics, cloud computing, and the IoT, are enabling new business models and transforming industries. Customers today expect personalized, convenient, and seamless experiences across all touchpoints. Digital disruptors leverage technology to meet these expectations and provide innovative solutions that traditional players may struggle to match. Digital disruptors often introduce new business models that challenge traditional industry structures. Examples include sharing economy platforms like Airbnb and Uber, which have disrupted the hospitality and transportation industries, respectively. Digital disruptors leverage data as a strategic asset to

gain insights into customer behavior, preferences, and market trends. They use this data to drive innovation, improve customer experiences, and create new revenue streams. Digital disruptors are often more agile and flexible than traditional players. They can quickly adapt to market changes, experiment with new ideas, and iterate their products and services based on customer feedback. Digital disruptors can often offer products and services at lower costs compared to traditional players. They leverage technology to automate processes, reduce overheads, and optimize operations, allowing them to provide competitive pricing. Regulatory changes can also drive digital disruption by creating opportunities for new entrants or forcing traditional players to adapt. For example, the emergence of open banking regulations has paved the way for FinTech companies

to offer innovative financial services. It's important to note that these drivers can vary across industries, and the extent of disruption depends on the specific context and market dynamics.

The drivers of digital disruption in industry are multifaceted and interconnected, reflecting the complex nature of the digital landscape. These drivers interact in complex ways to shape the landscape of digital disruption in various industries. Understanding these drivers can help businesses anticipate potential disruptions and adapt their strategies accordingly [1][2]. The main three drivers of digital disruption in industry are shown in figure 1 and are explained as follows:



**Figure 1: Drivers of Digital Disruption in Industry**

India's manufacturing sector is poised for a significant transformation driven by Industry 5.0, the next stage of industrial evolution. This era builds upon Industry 4.0's automation and intelligence with a focus on human-centricity and sustainability. Here's how technical advancements and innovation are disrupting the landscape:

**Tech-driven disruption**

- **Industrial Metaverse:** The marriage of IoT sensors, 5G connectivity, and virtual reality (VR) creates a digital twin of the factory floor. This allows real-time monitoring, remote maintenance, and improved decision-making, leading to flawless production and reduced downtime
- **Collaborative Robotics (Cobots):** Unlike industrial robots, cobots work alongside humans, assisting with repetitive tasks and improving worker safety.

This fosters a human-machine collaboration that enhances productivity and product quality.

- **AI and Machine Learning (ML):** AI algorithms analyze vast amounts of data collected from connected machines (IoT) to predict equipment failures, optimize production lines, and ensure consistent quality control.
- **Additive Manufacturing (3D Printing):** This technology enables on-demand, customized production, reducing waste and minimizing inventory needs. It opens doors for complex part creation and rapid prototyping.

Shifting customer expectations and behaviors are acting as a major catalyst for digital disruption in India's Industry 5.0 manufacturing landscape. Here's how:

**Demand for Personalization**

- **Mass Customization:** Customers today crave unique products tailored to their specific needs. Industry 5.0, with its focus on flexibility and data-driven insights, allows manufacturers to create customized products at scale.
- **Shorter Product Lifecycles:** Rapidly evolving trends demand faster product updates. 3D printing and agile manufacturing techniques enable quicker design iterations and production cycles, meeting the desire for constant novelty.

**Transparency and Sustainability**

- **Ethical Sourcing:** Customers are increasingly concerned about the environmental and social impact of the products they buy. Industry 5.0's emphasis on sustainability aligns with this by promoting resource efficiency, waste reduction, and ethical sourcing practices.
- **Supply Chain Visibility:** Customers want to know the origin and journey of their products. Blockchain technology, a key component of Industry 5.0, offers transparent and secure tracking throughout the supply chain, building trust and brand loyalty.

**Experience-Driven Commerce**

- **Omnichannel Engagement:** Customers expect seamless shopping experiences across online and



offline channels. Industry 5.0 facilitates this by integrating data from various sources, enabling personalized product recommendations and a unified buying journey.

- **Direct-to-Consumer (D2C) Brands:** The rise of D2C brands fueled by online marketplaces puts pressure on traditional manufacturers to provide a more personalized and interactive buying experience. Industry 5.0's focus on customer co-creation allows for gathering user feedback and incorporating it into product development, fostering deeper customer engagement

Globalization and the ever-increasing interconnectedness of the world are acting as a double-edged sword for Indian manufacturing in the Industry 5.0 era, driving disruption in both positive and challenging ways:

#### **Increased Competition and Efficiency**

- **Global Marketplace:** Globalization exposes Indian manufacturers to a wider customer base and intense competition. This pressure to innovate and improve efficiency is a key driver of digital adoption. Industry 5.0 technologies like AI and automation allow manufacturers to optimize production lines, reduce costs, and remain competitive on the global stage.
- **Global Supply Chains:** Interconnectedness fosters complex global supply chains. Industry 5.0's focus on real-time data sharing and collaboration platforms enables better visibility throughout the chain, optimizing logistics and streamlining production processes.

#### **Challenges and the Need for Adaptation**

- **Standardization and Interoperability:** A successful globalized Industry 5.0 ecosystem requires standardized protocols for data exchange and machine communication. India needs to actively participate in developing these standards to ensure its manufacturing sector can seamlessly integrate into global networks.
- **Cybersecurity Threats:** The interconnected nature of Industry 5.0 opens doors to cyberattacks that can disrupt production and compromise sensitive data. Robust cybersecurity measures and international

collaboration are crucial to safeguard critical infrastructure.

#### **Opportunities for India**

- **Skilled Workforce for the Global Market:** Industry 5.0 demands a skilled workforce with expertise in data analysis, AI, and digital technologies. India's large talent pool can be a major asset if it focuses on upskilling and creating a globally competitive workforce.
- **Innovation and Collaboration:** Globalization fosters knowledge sharing and collaboration between international players. India can leverage this by partnering with foreign companies for technology exchange and joint research ventures, accelerating its own Industry 5.0 advancements.

#### **Technological Advancements and Innovation**

Technological advancements and innovation are indeed key drivers of digital disruption in industries. Technological advancements and ongoing innovation play a pivotal role in driving digital disruption in various industries. The rapid evolution of technologies such as AI, ML, big data analytics, cloud computing, and the IoT has opened up new possibilities and revolutionized traditional business processes. These advancements enable organizations to collect and analyze vast amounts of data, automate tasks, improve operational efficiency, and create innovative products and services. Technological breakthroughs act as catalysts for change, empowering industries to adopt digital solutions and transform their operations to remain competitive in a rapidly evolving digital landscape [3]. Technological advancements enable the creation of new business models that challenge traditional industry structures. For example, the rise of e-commerce platforms like Amazon disrupted the retail industry by offering a new way of buying and selling products online. Emerging technologies such as AI, ML, blockchain, and the IoT have the potential to disrupt industries by introducing new ways of doing business. For instance, AI-powered chatbots are transforming customer service in various sectors, while blockchain technology is revolutionizing supply chain management and financial transactions.

Technological advancements allow companies to deliver personalized and seamless customer experiences. For

example, companies can leverage data analytics and AI to understand customer preferences and provide tailored recommendations, leading to higher customer satisfaction and loyalty. Innovation in technology often leads to increased efficiency and productivity in industries. Automation, robotics, and advanced analytics enable companies to streamline processes, reduce costs, and improve operational efficiency. This can disrupt traditional industries by offering faster and more cost-effective solutions. Digital technologies have made it easier for companies to access global markets and reach a wider customer base. E-commerce platforms and digital marketing tools enable businesses to expand their reach beyond geographical boundaries, disrupting traditional market dynamics. Technological advancements foster collaboration and the formation of ecosystems where different players come together to create innovative solutions. These ecosystems can disrupt traditional industry value chains by bringing together diverse expertise and resources [4].

### **Changing Customer Expectations and Behaviors**

Changing customer expectations and behaviors are powerful drivers of digital disruption in industries. Customer expectations and behaviors are dynamic and constantly evolving in response to technological advancements and changing societal trends. The digital age has given rise to tech-savvy consumers who demand personalized experiences, convenience, and seamless interactions across multiple channels. Customers expect real-time information, personalized recommendations, frictionless transactions, and superior customer service. As a result, industries need to adapt and leverage digital technologies to meet these evolving customer expectations. Failure to do so can lead to customer dissatisfaction, loss of market share, and ultimately, disruption by more digitally adept competitors [5]. Customers today expect personalized experiences tailored to their specific needs and preferences. Digital disruptors leverage technology to collect and analyze customer data, enabling them to deliver highly personalized products, services, and recommendations. This demand for personalization disrupts traditional one-size-fits-all approaches.

Customers increasingly value convenience and immediacy in their interactions with businesses. Digital

disruptors leverage technology to offer on-demand services, seamless transactions, and quick response times. This shift towards convenience disrupts industries that rely on traditional, time-consuming processes. Customers are increasingly comfortable using digital channels for their interactions with businesses. They expect companies to have a strong online presence, provide self-service options, and offer seamless omnichannel experiences. Digital disruptors capitalize on this trend by providing digital-first or digital-only solutions, challenging traditional brick-and-mortar businesses. Customers today value transparency and trust in their relationships with businesses. They seek information about the products they purchase, the companies they engage with, and the impact of their choices. Digital disruptors leverage technology to provide transparent information, build trust through user reviews and ratings, and offer sustainable and socially responsible solutions.

Social media platforms have transformed the way customers discover, evaluate, and engage with brands. Customers rely on peer recommendations, online reviews, and social media influencers to inform their purchasing decisions. Digital disruptors leverage social media and influencer marketing strategies to reach and engage with customers, challenging traditional marketing approaches. Customers are increasingly embracing subscription-based models and sharing economy platforms. They value access over ownership and seek cost-effective and flexible solutions. Digital disruptors leverage these models to offer subscription services, shared resources, and collaborative platforms, disrupting traditional ownership-based industries.

The widespread adoption of smartphones and mobile technologies has transformed customer behaviors. Customers expect businesses to provide mobile-friendly experiences, such as mobile apps, mobile payments, and location-based services. Digital disruptors leverage mobile technologies to offer innovative solutions and capture the growing mobile-first customer segment.

### **Globalization and Interconnectedness**

Globalization and the increasing interconnectedness of economies have created a fertile ground for digital disruption. The ease of communication, collaboration,

and exchange of information facilitated by the internet and digital platforms has accelerated the pace of innovation and disruption. Companies can now operate globally, access new markets, and collaborate with partners and suppliers across geographical boundaries. This interconnectedness exposes industries to disruptive forces from both domestic and international players. It also enables the rapid spread of innovative ideas, best practices, and new business models, creating opportunities for digital disruption to occur across industries [6].

Globalization has opened up new markets and expanded the potential customer base for businesses. Digital technologies and the internet have made it easier for companies to reach customers in different countries and regions. This increased market reach disrupts traditional industry boundaries and creates opportunities for new entrants. Globalization encourages cross-border collaboration and partnerships between companies. Digital platforms and communication tools facilitate collaboration across different time zones and geographies. These collaborations can lead to the development of innovative solutions and disrupt traditional industry dynamics. Globalization brings increased competition as companies from different countries and regions enter new markets. Digital disruptors leverage technology to offer competitive products, services, and pricing. This heightened competition forces traditional players to adapt and innovate to stay relevant in the global marketplace [7].

Globalization facilitates the sharing of knowledge, best practices, and industry trends across borders. Digital platforms, industry forums, and online communities enable professionals to exchange ideas and learn from each other. This knowledge sharing accelerates innovation and disrupts industries by introducing new ideas and approaches.

## ENABLING TECHNOLOGIES OF DIGITAL DISRUPTION

Several key technologies are enabling digital disruption across industries. These technologies are not only transforming the way businesses operate but also reshaping customer expectations and market dynamics. They drive the transformation of business

models, encouraging organizations to embrace digital strategies, adopt agile practices, and leverage emerging technologies. By harnessing these enablers, companies can introduce disruptive products and services, streamline operations, enhance customer experiences, and gain a competitive edge. Digital disruption is a dynamic process that continually evolves as organizations adapt to the changing landscape and leverage these enablers to drive innovation and growth. These enabling technologies are at the heart of digital disruption, offering new ways to create value, engage with customers, and compete in the digital age.

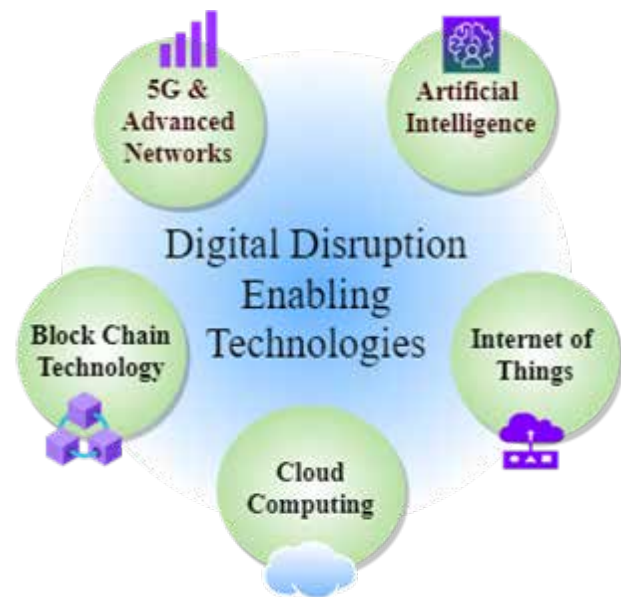

**Figure 2 Enabling Technologies of Digital Disruption**

The Figure 2 illustrates the key enabling technologies driving digital disruption across industries. Digital Disruption Enabling Technologies is encircled by five pivotal components: 5G & Advanced Networks, AI, IoT, Cloud Computing, and Blockchain Technology. Each of these technologies contributes uniquely to the transformation of industry landscapes. 5G and Advanced Networks enhance connectivity and data transfer speeds, enabling real-time communication and remote operations. AI facilitates intelligent automation, data analysis, and decision-making processes. IoT connects devices and systems, allowing for seamless data exchange and smarter operations. Cloud Computing provides scalable and flexible computing resources, supporting digital infrastructure and services.

Blockchain Technology ensures secure and transparent transactions, fostering trust and efficiency in digital interactions. Together, these technologies synergize to drive innovation, efficiency, and new business models in the digital era.

## RESEARCH CHALLENGES RELATED TO DIGITAL DISRUPTION

Digital disruption presents a multitude of research challenges that industries must navigate to harness its full potential. One significant challenge is the integration of new digital technologies with existing legacy systems, which often involves complex interoperability issues that can disrupt ongoing operations. Data privacy and security also pose critical concerns, as the increasing volume of data generated and shared in digital ecosystems heightens the risk of cyber threats. Regulatory and compliance issues add another layer of complexity, with technological advancements frequently outpacing existing regulatory frameworks, leading to uncertainties and legal challenges. The transformation of the workforce is crucial, as industries need to invest in upskilling and reskilling employees to adapt to new technologies, a process that is both time-consuming and resource-intensive. Additionally, the high cost of implementing digital technologies can be prohibitive, particularly for small and medium-sized enterprises (SMEs), making it essential to balance initial investments with long-term benefits. Technological uncertainty further complicates strategic planning, as rapid innovations can render current technologies obsolete quickly. Organizational culture also plays a pivotal role, with resistance to change from both employees and management potentially hindering the adoption of digital initiatives. Measuring the return on investment (ROI) for digital transformation efforts is another challenging aspect, requiring robust metrics to quantify both direct and indirect benefits. Moreover, sustainability and ethical considerations are increasingly important, as industries must ensure that their digital initiatives are environmentally sustainable and socially responsible. Lastly, maintaining global competitiveness in a rapidly digitalizing world demands continuous innovation and agility, necessitating that industries stay abreast of global digital trends to retain their competitive edge. Addressing these multifaceted

challenges is essential for industries to successfully navigate the digital disruption landscape.

Digital disruption in various industries presents unique challenges that must be carefully navigated to fully leverage its potential. A significant challenge lies in the integration of new digital technologies with existing legacy systems, which can be complex and risk disrupting ongoing operations. Data privacy and security concerns are paramount, as the increase in data volume generated and shared through digital ecosystems heightens the risk of cyber threats and necessitates robust security measures. Regulatory and compliance issues add further complexity, with technological advancements frequently outpacing current regulatory frameworks, leading to uncertainties and legal challenges. Transforming the workforce is crucial, as industries must invest in upskilling and reskilling employees to adapt to new technologies, a process that is both time-consuming and resource-intensive.

Additionally, the high cost of implementing digital technologies can be prohibitive, particularly for small and SMEs, necessitating a careful balance between initial investments and long-term benefits. Technological uncertainty complicates strategic planning, as rapid innovations can quickly render existing technologies obsolete. Organizational culture is another critical factor, as resistance to change from both employees and management can hinder the adoption and successful implementation of digital initiatives. Measuring the ROI for digital transformation efforts is challenging, requiring robust metrics to quantify both direct and indirect benefits.

Sustainability and ethical considerations are increasingly important, as industries must ensure their digital initiatives are environmentally sustainable and socially responsible. Global competitiveness also demands continuous innovation and agility, requiring industries to stay updated on global digital trends to maintain their competitive edge. Each industry faces specific challenges due to digital disruption. For instance, the manufacturing sector grapples with the integration of IoT and AI for smart factories, which requires significant capital investment and workforce training. The healthcare industry faces the challenge



of ensuring data security and patient privacy while adopting digital health records and telemedicine. Financial services must navigate stringent regulatory requirements while implementing blockchain and AI for improved efficiency and security.

Retailers confront the challenge of transitioning to e-commerce and omnichannel strategies while maintaining customer engagement and loyalty. The energy sector must adapt to smart grid technologies and renewable energy sources, requiring substantial infrastructure changes. Education faces the challenge of integrating digital learning platforms and ensuring equitable access to technology for all students. Addressing these multifaceted challenges is essential for industries to successfully navigate the landscape of digital disruption, fostering innovation, efficiency, and sustainable growth.

## CONCLUSION

Digital disruption is profoundly transforming industries, driving innovation, efficiency, and new business models. It also presents numerous challenges that industries must navigate to harness its full potential. Integrating new digital technologies with existing legacy systems can be complex and disruptive. Ensuring data privacy and security is paramount as the volume of data increases. Regulatory and compliance issues add further complexity, with technological advancements often outpacing existing frameworks. Transforming the workforce through upskilling and reskilling is crucial but resource-intensive. The high cost of implementing digital technologies can be prohibitive, especially for small and medium-sized enterprises, necessitating a balance between initial investments and long-term benefits. Technological uncertainty complicates strategic planning, as rapid innovations can quickly render existing technologies obsolete. Specific industries face unique challenges due to digital disruption. The manufacturing sector must integrate IoT and AI for smart factories, the healthcare industry must ensure data security and patient privacy, financial services must navigate stringent regulatory requirements while implementing blockchain and AI, retailers must transition to e-commerce and omnichannel strategies, the energy sector must adapt to smart grid technologies

and renewable energy sources, and education must integrate digital learning platforms and ensure equitable access to technology.

Future research should focus on developing frameworks and strategies to address these challenges effectively. This may include creating robust models for integrating digital technologies with legacy systems, enhancing data privacy and security measures, and developing adaptive regulatory frameworks that keep pace with technological advancements. Comparative studies across industries can offer valuable lessons and best practices for managing digital disruption. As digital technologies continue to evolve, ongoing research will be essential to help industries navigate the complexities of digital disruption and leverage its potential for sustainable growth and global competitiveness.

## REFERENCE

1. Gillpatrick, T., Blunck, E., & Boža, S. (2019, November). Understanding the role of consumer behavior in forecasting the impact of industry 4.0 and the wave of digital disruption driving innovation in retailing. In DIEM: Dubrovnik International Economic Meeting (Vol. 4, No. 1, pp. 165-176).
2. Pankewitz, C. (2017). Automation, robots, and algorithms will drive the next stage of digital disruption. *Phantom ex machina: Digital disruption's role in business model transformation*, 185-196.
3. Appio, F. P., Lima, M., & Paroutis, S. (2019). Understanding Smart Cities: Innovation ecosystems, technological advancements, and societal challenges. *Technological Forecasting and Social Change*, 142, 1-14.
4. Khan, M. K. (2020). Technological advancements and 2020. *Telecommunication Systems*, 73, 1-2.
5. Sahai, G., & Seth, A. (2020). Changing Business Operations in Disruptive Times—a review paper.
6. Glattfelder, J., & Battiston, S. (2019). The architecture of power: Patterns of disruption and stability in the global ownership network. Available at SSRN 3314648.
- [7]. Cave, J., Van Oranje, C., Schindler, R., Shehabi, A., Robinson, N., & Ph-B, B. (2009). Trends in connectivity technologies and their socio-economic impacts. *DG Information society and Media*.



# Advancing Education for Achieving Sustainable Development Goals (SDGs)

## Shivani Kale

Associate Professor  
CSE Dept  
Dr. D. Y. Patil Pratishthan's College of Engg  
Kolhapur, Maharashtra  
✉ dr.shivaanikalle@gmail.com

## Vidya. N. Abdulpur

Assistant Professor  
Electrical Dept.  
Dr. D. Y. Patil Pratishthan's College of Engg  
Kolhapur, Maharashtra  
✉ vidyamohan.123@gmail.com

## Preeti Bhosale

TPO  
Dr. D. Y. Patil Pratishthan's College of Engg  
Kolhapur, Maharashtra  
✉ tpodypsn@gmail.com

## Suresh Mane

Principal  
Dr. D. Y. Patil Pratishthan's College of Engg  
Kolhapur, Maharashtra  
✉ mane.suresh@gmail.com

## ABSTRACT

Education is a critical component of sustainable development, recognized as a standalone goal (SDG 4) in the United Nations' 2030 Agenda for Sustainable Development. This paper explores the multifaceted role of education in achieving the SDGs, examining its impact on economic growth, social inclusion, environmental sustainability, and overall human well-being. By analyzing global initiatives, policies, and case studies, this paper underscores the transformative power of education and calls for increased investment and innovation in the education sector to meet the ambitious targets set for 2030.

## INTRODUCTION

The Sustainable Development Goals (SDGs), adopted by all United Nations Member States in 2015, provide a universal framework to address pressing global challenges such as poverty, inequality, climate change, environmental degradation, peace, and justice. Education is prominently featured as SDG 4: "Ensure inclusive and equitable quality education and promote lifelong learning opportunities for all." This goal is not only an end in itself but also a means to achieve other SDGs. This paper examines the integral role of education in sustainable development, highlighting key initiatives, challenges, and strategies to enhance educational outcomes worldwide.

### The Role of Education in Sustainable Development

This diagram 1 shows the interconnection between education (SDG 4) and other SDGs. It demonstrates how education impacts various aspects of sustainable

development, such as economic growth, social inclusion, environmental sustainability, and health.



Fig. 1: Interconnection between education (SDG 4) and other SDGs

**Economic Growth**

Education is a catalyst for economic growth and development. An educated workforce is more productive, innovative, and capable of driving economic progress. Studies show a positive correlation between education levels and economic performance. For instance, countries with higher literacy rates tend to have higher GDP per capita. Moreover, education reduces poverty by equipping individuals with skills and knowledge needed for better employment opportunities.

**Social Inclusion and Equity**

Education promotes social inclusion by providing opportunities for marginalized and disadvantaged groups. It empowers individuals, particularly women and girls, to participate fully in societal, political, and economic life. Education helps reduce inequalities by ensuring that everyone, regardless of their background, has access to learning opportunities. Programs aimed at inclusive education focus on removing barriers and creating supportive learning environments for all students.

**Environmental Sustainability**

Education fosters environmental awareness and responsibility. Environmental education teaches students about the importance of conserving natural resources, reducing waste, and mitigating climate change. By integrating sustainability into the curriculum, educational institutions can inspire future generations to adopt sustainable practices and contribute to environmental preservation.

**Health and Well-being**

There is a strong link between education and health outcomes. Educated individuals are more likely to adopt healthy behaviors, access healthcare services, and make informed decisions about their health. Education also plays a crucial role in addressing public health issues such as infectious diseases, malnutrition, and maternal and child health. Schools can serve as platforms for health education, promoting healthy lifestyles and disease prevention.

**Global Initiatives and Policies Supporting Education in SDGs**

This diagram 2 outlines the specific targets and indicators under SDG 4. It helps to understand the scope of SDG 4 and the different aspects of education it aims to address.



Fig .2 specific targets and indicators under SDG 4

**United Nations Educational, Scientific and Cultural Organization (UNESCO)**

UNESCO leads the global education agenda through the Education 2030 Framework for Action, which provides guidance to countries on implementing SDG 4. UNESCO supports member states in developing inclusive and equitable education systems, enhancing the quality of education, and promoting lifelong learning opportunities.

**Global Partnership for Education (GPE)**

The GPE is a multi-stakeholder partnership that mobilizes resources and provides financial and technical assistance to developing countries. It focuses on strengthening education systems, improving learning outcomes, and ensuring that all children, especially the most vulnerable, have access to quality education.

## Education Cannot Wait (ECW)

ECW is a global fund dedicated to education in emergencies and protracted crises. It aims to provide safe, free, and quality education to children affected by conflicts, natural disasters, and displacement. ECW collaborates with governments, humanitarian organizations, and donors to address the urgent educational needs of crisis-affected populations.

## CHALLENGES IN ACHIEVING SDG 4

### Funding and Resource Allocation

Adequate funding is crucial for achieving SDG 4, yet many countries face significant financing gaps. Investment in education must be prioritized to build infrastructure, train teachers, and develop curricula. Innovative financing mechanisms, such as public-private partnerships and international aid, are needed to bridge the funding shortfall.

### Quality of Education

Ensuring the quality of education is as important as access. Many education systems suffer from poor teaching standards, outdated curricula, and inadequate learning materials. Improving teacher training, curriculum development, and assessment methods are essential to enhance the quality of education.

### Inclusivity and Equity

Despite progress, disparities in education access and outcomes persist. Marginalized groups, including girls, children with disabilities, and those from low-income families, often face barriers to education. Policies and programs must focus on removing these barriers and creating inclusive learning environments.

### Technological Integration

The digital divide poses a significant challenge to achieving SDG 4. Access to technology and digital literacy are critical for modern education. Investments in digital infrastructure, teacher training in technology use, and equitable access to digital learning tools are necessary to bridge the gap.

## CASE STUDIES

### Finland: A Model for Educational Excellence

Finland is renowned for its high-quality education system, characterized by student-centered learning, highly qualified teachers, and a focus on equity. The Finnish model emphasizes holistic development, critical thinking, and lifelong learning. Finland's success demonstrates the impact of well-resourced and inclusive education policies.

### Rwanda: Rebuilding through Education

Rwanda has made significant strides in rebuilding its education system after the 1994 genocide. The government prioritized education as a key driver of national development, investing in teacher training, infrastructure, and technology. Rwanda's efforts have led to increased enrollment rates, improved gender parity, and enhanced learning outcomes.

### Bangladesh: Promoting Girls' Education

Bangladesh has implemented successful programs to promote girls' education, recognizing its importance for social and economic development. Initiatives such as stipends for girls, female-friendly school environments, and community awareness campaigns have contributed to higher enrollment and retention rates for girls.

## RECOMMENDATIONS FOR ENHANCING EDUCATION IN THE CONTEXT OF SDGS

1. **\*\*Increase Investment in Education\*\*:** Governments and international organizations should allocate sufficient resources to education, focusing on infrastructure, teacher training, and curriculum development.
2. **\*\*Promote Inclusive and Equitable Education\*\*:** Policies should address barriers to education for marginalized groups, ensuring that all children have access to quality learning opportunities.
3. **\*\*Enhance Teacher Training and Professional Development\*\*:** Teachers are central to educational quality. Continuous professional development and training in innovative teaching methods are essential.

4. **\*\*Integrate Technology in Education\*\***: Investments in digital infrastructure and digital literacy programs can help bridge the digital divide and enhance learning outcomes.
5. **\*\*Strengthen Public-Private Partnerships\*\***: Collaboration between governments, the private sector, and civil society can mobilize additional resources and expertise to support education initiatives.

## CONCLUSION

Education is a cornerstone of sustainable development, integral to achieving the SDGs. By fostering economic growth, social inclusion, environmental sustainability, and improved health outcomes, education drives progress across multiple dimensions of development. Despite the challenges, concerted efforts by governments, international organizations, and stakeholders can transform the education landscape, ensuring that every individual has the opportunity to learn and thrive. As the world works towards the 2030 Agenda, education must remain a top priority to build a more inclusive, equitable, and sustainable future for all.

## REFERENCES

Here are some references you can use for your paper on supporting education in the context of the Sustainable Development Goals (SDGs):

1. United Nations. (2015). Transforming Our World: The 2030 Agenda for Sustainable Development. Retrieved from <https://sustainabledevelopment.un.org/post2015/transformingourworld>
2. UNESCO. (2016). Education 2030: Incheon Declaration and Framework for Action for the implementation

- of Sustainable Development Goal 4. Retrieved from <https://unesdoc.unesco.org/ark:/48223/pf0000245656>
3. Global Partnership for Education. (2020). Annual Report 2020. Retrieved from <https://www.globalpartnership.org/content/gpe-annual-report-2020>
4. Education Cannot Wait. (2020). Annual Results Report 2020. Retrieved from <https://www.educationcannotwait.org/resource-library/annual-results-report-2020>
5. UNESCO Institute for Statistics. (2021). SDG 4 Data Digest: How to Produce and Use the Global and Thematic Education Indicators. Retrieved from <http://uis.unesco.org/en/topic/sdg-4>
6. World Bank. (2018). World Development Report 2018: Learning to Realize Education's Promise. Washington, DC: World Bank. Retrieved from <https://www.worldbank.org/en/publication/wdr2018>
7. United Nations Children's Fund (UNICEF). (2020). Education: The Journey of Every Child. Retrieved from <https://www.unicef.org/reports/education-journey-every-child>
8. Rwanda Ministry of Education. (2019). Education Sector Strategic Plan 2018/19 to 2023/24. Retrieved from [https://www.mineduc.gov.rw/fileadmin/user\\_upload/pdf\\_files/2019\\_Rwanda\\_ESSP\\_2018-2024.pdf](https://www.mineduc.gov.rw/fileadmin/user_upload/pdf_files/2019_Rwanda_ESSP_2018-2024.pdf)
9. Finland Ministry of Education and Culture. (2019). Education Policy Outlook: Finland. Retrieved from <https://www.oecd.org/education/Education-Policy-Outlook-Country-Profile-Finland-2019.pdf>
10. United Nations Development Programme (UNDP). (2019). Human Development Report 2019: Beyond income, beyond averages, beyond today – Inequalities in human development in the 21st century. Retrieved from <http://hdr.undp.org/en/2019-report>

# Reflection of Sustainable Development Goals (SDGs) in the Teacher Education Curriculums

**Supriya K. Patil**

Contributory Teacher  
Department of Education  
Shivaji University  
Kolhapur, Maharashtra  
✉ skppdf19@gmail.com

**Nagina S. Mali**

Post Doctoral Research Fellow  
Department of Education  
Shivaji University  
Kolhapur, Maharashtra  
✉ naginamali2012@gmail.com

**P. S. Patankar**

Head  
Department of Education  
Shivaji University  
Kolhapur, Maharashtra  
✉ pratibhaspatankar@gmail.com

## INTRODUCTION

The concept of sustainable development (SD) can be interpreted in many ways. It is an awareness of the environmental, social and economic sector of the society. SD is development that meets the needs of the present, without compromising the ability of future generations to meet their different needs. It is about finding better ways of doing things, not only the future but also present. We need to change the way of work and live now, but this doesn't mean our quality of life will be reduced. It provides method to make better decisions on the issues that affect all of our lives. By incorporating health, economic, environmental into the planning of new communities or groups, for instance, we can ensure that residents have easy access to all facilities and leisure life.

The 2030 Agenda for SD, adopted by all United Nations Member States in 2015, provides a shared dimensions for peace and prosperity for people and the planet, for today and future. At its heart are the 17 Sustainable Development Goals (SDGs), which are a crucial call for action by all countries - developed and developing - in a global enterprise. They identify that ending poverty and other deficiencies must go hand-in-hand with strategies plan that improve health and education, reduce inequality and spur economic growth – all while attempting environment change and working to protect our oceans and jungles. In the form of SD education

performs very vital role within. Hence, Education is one of the most influential and universally recognized vehicles for SD.

## EDUCATION FOR SUSTAINABLE DEVELOPMENT (ESD)

Education for sustainable development springs learners of all ages the knowledge, understanding, skills, responsibilities, values and action to address interconnected and interrelated global challenges including climate change, damage of biodiversity, unsustainable use of resources, and inequality. It empowers learners of all ages to make informed decisions and take specific and joint action to change society and care for the planet. ESD is a lifelong learning process and an essential part of quality education. It increases the cognitive, socio-emotional and behavioral dimensions of learning and comprehends learning content and learning outcomes, pedagogy and the learning atmosphere itself. UNESCO focuses on five main areas of ESD are as follow-

- Advancing policy
- Transforming learning environments
- Building capacities of educators
- Empowering and mobilizing youth
- Accelerating local level action



## ROLE OF TEACHER EDUCATION IN SUSTAINABLE DEVELOPMENT

W. H. Kilpetrick said that Teacher education includes teaching skills, sound pedagogical theories and professional skills. National curriculum framework for teacher education- 2009 has declared some objectives of teacher education and one of them is- To develop outlooks of equitable and SD. It obviously states that teacher is a spring that enhances values of equitable and sustainable development in all dimensions of the society so it is necessary that they should be educated through perspective of gender equality, peace, respect of rights of all.

Education is a basic element by which growth and development of any Nation is measured. Level of education chooses the status of the country. We cannot ignore to Teacher education is an integral part of education process in India. It is not only an institutional based training programme today, but it is cause of social and national rebuilding and renaissance. Quality of teacher education is urgent need of India. It is now widely recognized that most active pathways to improve student's learning outcomes is quality of teaching, particularly teachers' capacity to motivate and facilitate such learning. Quality of teacher is directly accompanying with student's achievement so it is important that trained teachers should inspire students for effective learning. Teacher should be a role model for students so that cultivation of values in students may be improved. The cultivation, social awareness, economical attention and tendency to protect the environment etc. are the basic components of Sustainable Development, today. If a teacher is well conscious about all these concerns, then directly or indirectly, he is concerning with SD. Therefore, one of the best ways to achieve goals of SD, teacher education is operative tool. The quality of teacher is determined by their training so teacher education programme provide high quality teachers for the student centered and lifelong learning.

### SDG GOALS

In 2015, the United Nations member states adopted the Sustainable Development Goals (SDGs), with the aim of creating a more just, sustainable, and peaceful world

by 2030. At its heart are the 17 Sustainable Development Goals (SDGs), which are an urgent call for action by all countries - developed and developing - in a global partnership. The 17 Goals are as follow-

Eliminate Poverty, Erase Hunger, Establish Good Health and Well-Being, Provide Quality Education, Enforce Gender Equality, Improve Clean Water and Sanitation, Grow Affordable and Clean Energy, Create Decent Work and Economic Growth, Increase Industry, Innovation, and Infrastructure, Reduce Inequality, Mobilize Sustainable Cities and Communities, Influence Responsible Consumption and Production, Organize Climate Action, Develop Life Below Water, Advance Life On Land, Guarantee Peace, Justice, and Strong Institutions, Build Partnerships for the Goals.

### Importance in Curriculum

The SDGs comprehend a wide range of skills, including problem-solving, critical thinking, collaboration and communication. Integrating the SDGs into the curriculum provides student with opportunity to develop these essential skills, equipping them for future challenges and careers.

Integrating the SDGs into the curriculum presents opportunities for relevance, multidisciplinary and interdisciplinary learning and skill expansion. However, challenges such as curriculum overload, implementation complexities, adaptability, assessment demands and teacher capacity should be cautiously addressed to exploit the benefits of this integration. Striking a balance between the SDGs and a well-rounded curriculum is crucial, emphasizing the commitment and capacity of educators, schools and educational systems to effectively integrate sustainability concepts and skills.

### REVIEW OF LITERATURE

The main focus of the Marta and Desire (2023) in 'Awareness and Knowledge of the Sustainable Development Goals in Teacher Training' research that to analyze the degree of awareness and knowledge about the Sustainable Development Goals amongst students studying Education Degrees. After researching the results recommend that there is a need to improve awareness, training and implementation of the SDGs in university teacher training.

Xinqun, Le Yu and Hao Wu studied on 'Awareness of Sustainable Development Goals among Students from a Chinese Senior High School' to measure the self-reported knowledge, sources of information, learning situations, priorities, the impact of personal life and career planning with respect to the SDGs to understand their cognition, learning inspiration and social enthusiasm. The suggestions were given that for improving the implementation of ESD comprehend to formal and non-formal education, publicity and curriculum integration to promote learning about the SDGs.

In the study of 'Awareness and Knowledge of the Sustainable Development Goals in a University Community in Southwestern Nigeria' done by the Akinlolu, Grace and etc. (2017) assesses the level of awareness, knowledge and attitudes towards the SDGs among members of a university community. For fulfilment of the study a cross-sectional survey was conducted on 450 students and staff of Osun State University, Southwestern Nigeria, selected from three of its six multi-campus via multi-stage sampling. Data were collected by questionnaire and analyzed using SPSS version 20.0. Conclusion was Pertinent individual and population-level methods of enlightening people about the SDGs must be put in place in educational settings; curricular changes are imperative.

Munish, Esan and etc. (2022) kept the aims to look at the perspectives of the SDG improvised to deliver quality education in the 'Sustainable Development Goal for Quality Education (SDG 4): A study on SDG 4 to extract the pattern of association among the indicators of SDG 4 employing a genetic algorithm' study. Conclusion of the study was SDG 4 under the sustainability development program is inspired to deliver quality education by eradicating the barriers of poverty, funding, costly education, discrimination and unavailability of resources.

The study 'Teachers' Awareness and Sustainable Development Goals Attainment in Secondary Schools in Bayelsa State' done by the Kanelechi, Nwangwa and igbogi, inatimi (2019) seeks to determine the awareness, perception and challenges of teachers towards the attainment of the SDGs in Bayelsa State. The result exposed that teacher in Bayelsa State had a low level

of awareness, positive perception and faced significant challenges which limit their contribution towards the attainment of the SDGs.

### Research Gap

It has been found that most research is conducted at the school level in other countries, with very few conducted in India, especially at the teacher education level. In order to instill awareness of the goals, it is necessary to ascertain how the papers explain the SDGs across the curriculum, since the course material calls for this kind of discussion. The curriculum's goal is to eliminate prejudices that stand in the way of the Sustainable Development Goals and raise knowledge of the best course of action for the future.

### Assumption

Sustainable Development Goals are reflected in B.Ed.-M.Ed.(Integrated) curriculum of Shivaji University, Kolhapur. Teacher Educators are practicing for implementing SDGs in the curriculum.

### Objective

Following objectives are kept by the researchers-

1. To analyze the content of curriculum from B.Ed.-M. Ed.(Integrated) of Shivaji University, Kolhapur.
2. To find out the practices implemented in the B.Ed.-M.Ed.(Integrated) curriculum of Shivaji University, Kolhapur related to Sustainable Development Goals No.5th and 16th by the teacher educators.

### Limitation and Delimitation

This study is limited with the B.Ed.-M.Ed.(Integrated) curriculum of Shivaji University, Kolhapur. This study limited with the Sustainable Development Goal Number 5th Enforce Gender Equality and Goal Number 16th Guarantee Peace, Justice, and Strong Institutions. Also, present study is delimited with the B.Ed.-M. Ed.(Integrated) Semester- V and VI.

## RESEARCH METHODOLOGY

Area of the study is to check SDGs goals reflected in the curriculum and practices implemented by teacher educators. Hence, for the present study Survey method is used for Documentary Analysis in which B.Ed.-M.

Ed. (Integrated) Semester V and VI curriculum is analyzed. Researcher made documentary analysis tool is used for present study. For the document analysis the papers / courses such as Gender, School and Society, Human Rights Education, Inclusive education,

Curriculum Studies, Contemporary Concerns and Issues in Education from semester V and Ethics, Universal human Values and Peace Education from semester VI is selected purposively. Also, teacher educators are selected purposively for informal group discussion. Throughout the process qualitative analysis is done.

**DATA ANALYSIS AND INTERPRETATION**

**Table 1. Analysis of B.Ed. M.Ed. Curriculum according to the Sustainable Development Goals No.5th**

Sr. No.	Indicators of the SDGs	Reflected Content
Goal No. 5 Enforce Gender Equality	Attain gender equality and empowering women and girls	Dealing with issues of gender required Life skills with training
	End procedures of discrimination against all women's as a gender part	Concept of harassment. Places of all Conflicts (including Social and Emotional conflict)
	To encourage, impose and monitor equal opportunity and non-discrimination on the basis of sex availability of Legitimate frameworks are in place	-----
	Discarding every harmful practices	Methods and techniques to reduce the Attitudes of parents and others with high expectations of all girls and boys.
	Leadership at all levels of decision making in political, economic and public with Conformity of women's with full involvement and equal opportunities	Constructing Gender in 21st century Curriculum frame work
	To commence reforms to provide women equal rights to economic resources	Agent of change : Teacher
	Promoting the empowerment of women through Enhancing the use particular information and communications technology,	Agencies disseminating family school workplace harassment and media(online and offline media )

**Table 2. Analysis of B.Ed. M.Ed. Curriculum according to the Sustainable Development Goals No. 16th**

Sr. No.	Indicators of the SDGs	Reflected Content
Goal No. 16-Guarantee Peace, Justice, and Strong Institutions	For the promotion of gender equality Implementing and establishing sound policies and enforceable legislation	Recommendations of committees, schemes & policies commissions and plans after 1986
	Building real, responsible and inclusive institutes from various levels for Encouraging peaceful and inclusive societies for sustainable development	1. Approaches to peace education and Awareness of relevance of peace and 2.Enhancing competencies for conflict transformation
	Reducing all forms of violence and death rates	Challenges to peace by increasing stresses ,conflicts ,crimes ,terrorism ,violence and wars resulting in poor quality of life  Social Ethics: The justification 'Civil Disobedience in a democratic state

Goal No. 16-Guarantee Peace, Justice, and Strong Institutions	all forms of violence against and torture of children as an end abuse, exploitation, trafficking	Consciousness of pedagogical skills and strategies for removing tensions at school level.
	Promotion of rules & law at the national and international levels and ensure equal access	-----
	Substantially reduce corruption and bribery	-----
	Develop effective, accountable and transparent institutions at all levels	Nature of conflict –Inappropriateness of needs, aspirations, desires and resulting conflicts at different levels in society
	Ensure responsive, inclusive, participatory and representative decision-making at all levels	Rethinking authority relations from democratic perspective :Promoting dialoguing and developing capabilities for decision –making
	Broaden and strengthen the participation of developing countries in the institutions of world-wide governance	assessment pattern to visible through objective indicators ,planning and recording change in cultural ethos and individuals .Understanding motivation sharing progress, encouragement of assessment
	Promote and enforce non-discriminatory laws and policies for sustainable development.	-----

**Observation and Interpretation (Regarding to the objective number 1)**

Above Table No.1 and 2 related to SDGs goal No. 5th(Enforce Gender Equality) and Goal No. 16th(Guarantee Peace, Justice, and Strong Institutions) with respect to the Semester V and Semester VIit is observed that-

1. From Semester V it is observed that Compulsory Paper Gender, School and Society is directly related with the Sustainable Development Goal No. 5-Enforce Gender Equality.
2. In the Optional Paper Human Rights Education only one content is covered related with the Gender Equality as Women Rights and Human Rights.
3. In the Optional Paper Inclusive education ‘Bias in Textbooks’ point is covered.
4. In the paper Curriculum Studies ‘Critical issues in curriculum construction with respect to the gender’ only one point is covered.
5. In the paper Contemporary Concerns and Issues in Education “Gender Bias: Education and Women” only one point is covered.
6. From Semester VI paper entitled Ethics, Universal human Values and Peace Education is directly

related with the Goal No. 16- Guarantee Peace, Justice, and Strong Institutions.

**Observation and Interpretation (Regarding to the objective number 2)**

Researchers interacted with the faculty members and discussed informally and it was observed and found that-

The practices for SDGs regarding Goals No.5th and 16th are conducted by the teachers in which Equal participation of girls and boys student teachers in the days celebration, Equal participation in work distribution, Participation in group discussion, Participation in planning of internship and preparation of timetables, Participation in planning of educational work, Allotment of work among the groups, Listening to the group members, Following instructions of the In Charge of work, Resolving the issues friendly, Expressing the views, Community engagement programmes are conducted for social awareness, discussion among the teachers and student teachers on any issue raised in the campus of the department, understanding individual problems and resolving it though discussion, promoting friendly climate in the campus, promoting helping nature, awareness campaign for society and school students and visit to slum area school, visit to tribal area

school is practiced as a practicum based etc. are very enthusiastically practiced by faculty members.

## CONCLUSION

From the above observation and interpretation, it is concluded that-

1. In the B. Ed. M.Ed. (Integrated) Curriculum of Shivaji University one Paper from the Semester V entitled Gender, School and Society Sustainable Development Goal No. 5 is reflected.
2. Sustainable Development Goal No. 16-Guarantee Peace, Justice, and Strong Institutions is totally reflected in the paper of Semester VI entitled Ethics, Universal human Values and Peace Education.
3. While considering the indicators related with the Goal No. 5 as Whether or not legal frameworks are in place to promote, enforce and monitor equality and non-discrimination on the basis of sex no any content is covered within this paper.
4. While considering the indicators related with the Goal No. 5 as Promote the rule of law at the national and international levels and ensure equal access to justice for all and promote and enforce non-discriminatory laws and policies for sustainable development is no any content is covered within this paper.

5. Teacher educators or faculty members are practicing for implementing the goals related to Sustainable Development Goals No.5th and 16th . As a reflection, student teachers are firmly following and participating in these practices of the curriculum as a whole.

## REFERENCES

1. Agarwal, P. (2006). " New trends in Education : The Need for Change." ICRIER Working.
2. Jimenez, A, Martin, M. ( 2007) Integrating education on Sustainability into Teacher Educators.
3. Siddiqui, M. A., Sharma, A. K, Arora, G. L., Teacher education reflection towards policy formulation, NCTE, New Delhi, India.
4. Sustainable development. And research in indai. Retrieved from <https://www.researchgate.net/publication/375379093> IG
5. Sustainable Development goal 4. Retrieved from <https://www.mdpi.com/2227-7102/11/9/458>
6. Sustainable Development goal 4. Retrieved from <https://www.ncbi.nlm.nih.gov/pmc/articles/PMC5811946/>
7. Sustainable Development goal 4. Retrieved from <https://link.springer.com/article/10.1007/s10639-022-11265-4>
8. Thakur, G. Challenges and problems in teaching higher education in India, Sanjay Prakashan, New Delhi, India.



# E- Content for Quality Education

## Afsana Harun Maneri

Research Student  
Department of Education  
Shivaji University  
Kolhapur, Maharashtra  
✉ afsana80@gmail.com

## Paratibha S. Patankar

Prof & Head  
Department of Education  
Shivaji University  
Kolhapur, Maharashtra  
✉ paratibhaspatankar@gmail.com

## ABSTRACT

E-content," an abbreviation for electronic content, is characterized by digital information, materials, or resources delivered and accessed through electronic devices like computers, tablets, and smartphones. It comprises diverse multimedia elements such as text, images, audio, video, and interactive components. E-content is specifically crafted for digital distribution and consumption, commonly available over the internet or through electronic platforms.

E-content represents the fusion of electronic content and Internet technology. In the current globalized educational context, there is a rising demand for accessible and captivating learning experiences. Students are increasingly inclined towards interactive and stimulating learning methodologies as opposed to traditional and monotonous approaches. The incorporation of e-content enables the extension of quality education to remote and rural regions, making use of contemporary technologies like satellites, the internet, and mobile devices. Satellites play a pivotal role in establishing connectivity among educational institutions, ensuring sufficient infrastructure for providing high-quality education to a broad population. This paper introduces an E-content model designed to enhance lectures and educational materials for students in remote areas, aiming to contribute to the overall improvement of education quality and interest.

### Objectives of this paper

1. To study the impact of e-content on digital literacy and fifth industrial revolution skills.
2. To exploration of barriers to adoption of e-content in education.
3. To explore the importance of e-content for quality education.

**KEYWORDS** : *E-content, E-learning, Quality education.*

## INTRODUCTION

As per the Oxford Dictionary, e-content is defined as digital text and images specifically crafted for display on web pages. Saxena Anurag (2011) describes e-content as a comprehensive package that meets criteria such as minimizing distance, cost-effectiveness, user-friendliness, and adaptability to local conditions.

E-content is widely accessible from various sources, but not all of them meet the desired standards in terms

of content, teaching methods, and technical aspects. Copyright violations are common, limiting the ability to customize e-content according to local needs. Additionally, there is an abundance of teacher and student-driven e-content available in the market, thanks to the prevalence of smart and mobile devices. Both organizations and individuals create e-content, but the quality of such content may be uncertain. Therefore, it is crucial to establish clear guidelines for developing high-quality and standardized e-content.



**Figure 1. Forms of E-content**

Source: <https://ciet.nic.in>

Forms of E-content-refers to the various kinds or styles of digital content that can be shared and used on the internet. E-content includes a variety of digital materials created for online use. Here are some common types:

1. Textual Content: Digital documents, articles, e-books, and written information presented in electronic form.
2. Multimedia Content: Content that mixes different media like images, audio, video, and interactive elements to share information or create a learning experience.
3. Audio Content: Podcasts, audiobooks, and other audio-based materials that can be played or downloaded.
4. Video Content: Educational videos, tutorials, lectures, and other audio-visual materials that can be watched or downloaded.
5. Interactive Content: Simulations, games, quizzes, and other content that involves users in a hands-on learning experience.
6. Graphic Content: Infographics, charts, diagrams, and other visual ways of showing information.
7. Animation and 3D Models: Moving images and three-dimensional representations that make learning more engaging.

Knowing about these different types of E-content helps in creating educational materials that suit specific learning goals and preferences.

## QUALITY EDUCATION



Throughout history, India has held a deep-rooted culture and perspective on education and enlightenment. This educational tradition has aimed to cultivate knowledge, skills, and positive attitudes, all of which are closely tied to the nation's educational objectives and constructive participation in society.

Quality education is really important for many reasons because it helps individuals grow, makes societies better, and contributes to the well-being of the whole world. Here are some key reasons why good education is so important:

1. Empowerment of Individuals: Quality education gives people the knowledge, skills, and ability to think critically, which helps them make smart decisions. It also boosts personal growth, self-confidence, and the feeling of being in control of one's life.
2. Economic Development: When many people in a country are well-educated, it helps the country grow economically. Educated people are skilled and can come up with new ideas, making the country more productive and competitive.
3. Reduction of Poverty: Education is like a powerful tool against poverty. It opens up opportunities for jobs, better income, and a chance to move up in society, breaking the cycle of poverty.
4. Social Equality and Inclusion: Good education ensures that everyone, no matter where they come from or who they are, gets the same chances. It helps bring people together and makes society more inclusive.
5. Health and Well-being: Education is connected to being healthy. When people know about health and

cleanliness, they tend to live healthier lives and feel better overall.

6. **Global Awareness and Cooperation:** Being educated means being aware of what's happening around the world. It helps people understand different cultures, work together globally, and solve big problems that affect everyone.
7. **Critical Thinking and Problem-Solving:** Good education teaches people how to think critically and solve problems. This is really useful in everyday life and helps in finding creative solutions to challenges.
8. **Civic Participation:** Education plays a big part in making responsible and informed citizens. It helps people understand their roles in society and encourages them to care about the well-being of others.
9. **Environmental Sustainability:** Learning about the environment is essential. Education creates awareness about environmental issues and encourages sustainable practices to protect our planet.
10. **Innovation and Progress:** Quality education inspires curiosity and creativity, leading to innovation and progress. It's a key factor in creating new technologies and making important discoveries.

The Quality education is not just about personal growth it's the foundation for building successful, inclusive, and sustainable societies around the world.

### Objectives of this paper

1. To study the impact of e-content on digital literacy and fifth industrial revolution skills
2. To exploration of barriers to adoption of e-content in education.
3. o explore the importance of e-content for quality education

### RESEARCH METHODOLOGY

The presented research paper is based on secondary sources. For this, various reference texts, articles, secondary sources like internet sources have been used and content analysis technique has been used.

## THE IMPACT OF E-CONTENT ON DIGITAL LITERACY AND FIFTH INDUSTRIAL REVOLUTION (5IR) SKILLS

### The impact of e-content on digital literacy

**Enhancing Skills:** E-content offers interactive and multimedia learning, helping with digital literacy by enhancing skills in using digital tools, assessing online information, and understanding digital communication.

**Global Connectivity/ Connecting Worldwide:** Having access to diverse E-content helps learners connect globally, exposing them to different views and digital methods.

### The impact of e-content on fifth industrial revolution (5IR) skills

**Innovation and Creativity:** E-content fosters a culture of curiosity and creativity, developing the innovation skills Conclusive for the 5IR. It encourages problem-solving and critical thinking, vital in dynamic industries.

**Building Adaptability:** E-content's interactive nature readies learners for quick technological changes seen in the 5IR, promoting adaptability and a continuous learning mindset.

**Collaboration / Improving Teamwork and Communication:** E-content platforms often have tools for working together, enhancing skills in virtual teamwork and effective communication.

## EXPLORATION OF BARRIERS TO ADOPTION OF E-CONTENT IN EDUCATION

The use of E-content in education can face many challenges, making it difficult to implement. Given below some common issues:

### Digital Infrastructure

**Limited Access to Technology:** Not everyone has the same access to digital devices and the internet, making it hard for students and teachers to use E-content effectively.

**Insufficient Connectivity:** Some areas, especially in rural places, have poor internet connections, creating problems for accessing and streaming E-content.

### Technological Literacy

**Lack of Digital Skills:** Teachers and students may not have enough training or knowledge about digital tools, which can make using E-content difficult.

**Resistance to Technology:** Some educators or schools might avoid using E-content because they feel unsure or uncomfortable with technology.

### Content Quality and Relevance

**Inadequate Content:** Poorly designed or irrelevant E-content may not match the curriculum or meet students' needs, affecting how much it gets used.

**Copyright Concerns:** Issues with copyright and ownership can limit how E-content is used and customized, causing worries for educators.

### Cost Considerations

**Financial Difficulties:** Getting digital devices, software, and high-quality E-content can be expensive, especially for schools or areas with limited money.

**Subscription Costs:** Some E-content platforms may require payment, making it hard for some schools or individuals to afford.

### Teacher Training and Support

**Inadequate Professional Development:** Teachers might not receive enough training on how to use E-content in their teaching, leading to underuse or ineffective use.

**Limited Technical Support:** There might not be enough help for teachers facing issues with E-content platforms, creating a barrier.

### Cultural and Language Barriers

**Cultural Resistance:** Some may resist using E-content because of cultural preferences or beliefs in traditional teaching methods, slowing down the adoption.

**Language Barriers:** Having E-content in various languages is important, and the lack of it can make it challenging for diverse language groups.

### Assessment and Evaluation

**Challenges in Assessment:** It can be hard to fit E-content into traditional assessment methods, especially when exams don't align with interactive or dynamic learning.

**Concerns About Cheating:** Educators may worry about cheating or plagiarism with E-content in assessments.

### Policy and Regulations

**Unclear Policies:** Lack of clear rules on using E-content in education can create uncertainty and hesitation among educators and institutions.

**Regulatory Hurdles:** Regulations limiting digital content or outdated policies can make it tough for E-content to be widely adopted.

To overcome these challenges, a comprehensive approach is needed, including investments in digital infrastructure, through teacher training, ensuring content quality, and creating supportive policies and regulations.

## HOW CAN E-CONTENT CONTRIBUTE TO ENHANCING THE QUALITY OF EDUCATION?

E-content, or electronic content, can contribute significantly to enhancing the quality of education in various ways. Here are several ways in which E-content can play a positive role:

1. **Accessibility and Flexibility:** E-content makes it easy for students to get their study materials anytime, anywhere. This is great because everyone can learn at their own pace and whenever it suits them.
2. **Multimedia Learning:** E-content often has cool things like videos, interactive games, and pictures. These make learning more fun and help you remember things better.
3. **Personalized Learning:** E-content can be made to fit your own way of learning. There are clever systems that adjust to how fast or slow you learn, making your learning experience more personal.
4. **Global Collaboration:** E-content helps students, teachers, and experts from all around the world work together. Online platforms allow you to connect with friends from different countries, helping you understand their cultures and collaborate on exciting projects.
5. **Real-time Updates:** E-content can be updated

instantly. This means you always get the latest information, especially in subjects that change quickly like technology or science.

6. **Cost-Effectiveness:** E-content is often cheaper than regular textbooks. You can find online resources, e-books, and digital materials that don't need printing and shipping, saving money for both schools and students.
7. **Interactivity and Engagement:** E-content lets you do cool things like quizzes, games, and discussions. These make learning more interactive, helping you apply what you've learned in a practical way.
8. **Feedback and Assessment:** E-content platforms can tell you right away how well you did in quizzes and assignments. This helps you see where you need to improve and keeps you learning and getting better.
9. **Inclusive Education:** E-content can be set up to help everyone, including those with different learning styles or abilities. It can include features like reading aloud or using subtitles to make sure everyone can learn together.
10. **Continuous Professional Development:** E-content is not just for students; it's great for teachers too! They can keep learning with online courses, webinars, and resources that help them stay on top of new ways to teach and what's happening in education.

In short, E-content makes education better by being flexible, fun, and available to everyone. It brings people together from all over the world, helps teachers keep learning, and makes your learning experience unique and exciting.

## REVIEW OF RELATED RESEARCH

Ahmad Tasnim Siddiqui, A. T., and Dr. Masud, M., (2012), "An E-learning System for Quality Education".

Dr. Mishra, U., Dr. Patel, S. and Doshi, K., (2017), "E-Content: An Effective Tool for Teaching and Learning in A Contemporary Education System.

Rukmani, V. and Dr. Gowrishankar, R., (2017), "Concept of E-Content Learning Environment in Higher Education: A Study.

Arun, A. and Dr. G. Singaravelu, (2019), "E-Content Development: future and provocation", wrote in this article the dual nature of the global village, emphasizing the significance of information sharing and the distinct identity that libraries can establish. It explores the transition to e-Books and open access journals while recognizing the challenges related to intellectual property rights. The influence of ICTs on heightened workload and the importance of e-Learning programs are acknowledged. The review highlights the necessity of producing digital content in the dynamic technological landscape and recommends the development of Android applications with user-friendly features.

Haleem, A. and et. al., (2022), "Understanding the role of digital technologies in education: A review", researcher explained in this paper the assessment emphasizes the beneficial influence of digital technology in education, simplifying tasks for educators and offering personalized learning experiences for students. It envisions a successful implementation ahead, improving the digital learning environment. Furthermore, the review recognizes the vital role of contemporary technologies in tackling environmental issues and fostering sustainable development.

## Summary of Literature Review

Current research emphasizes the beneficial role of technology, particularly E-content, in education and learning outcomes. Positive aspects encompass enhanced accessibility, flexibility, interactivity, and personalized learning. Nonetheless, persistent challenges such as unequal access, digital distractions, and the imperative for quality assurance need attention. Future studies should tackle these issues and seek inventive approaches to maximize the educational advantages of technology.

## E-content Implementation

E-content for this study, a varied set of digital materials is employed, comprising interactive modules and multimedia presentations designed to align with the curriculum. The chosen E-content distinguishes itself through innovative features like interactive simulations and real-world applications, creating a dynamic learning atmosphere. Challenges encountered encompass ensuring equal access to technology and dealing



with copyright considerations, necessitating strategic planning to achieve the best possible outcomes.

## PEDAGOGICAL IMPLICATIONS

### 1. Impact on Teaching Methods and Instructional Strategies:

The influence of E-content on teaching methods is substantial, emphasizing interactive and personalized instruction. It shifts towards student-centred and experiential learning, cultivating critical thinking skills.

### 2. Educators' Role in use of E-content:

Educators play a vital role in guiding students through E-content, grouping materials, and promoting digital literacy. They act as facilitators, fostering collaboration and adjusting teaching methods based on real-time data.

### 3. Implications for Curriculum Development:

The integration of E-content necessitates a reevaluation of curricula, facilitating the inclusion of dynamic and up-to-date content. Designers focus on aligning digital materials with learning objectives, ensuring coherence, and recognizing the need for continuous updates to maintain relevance.

## CHALLENGES AND SOLUTIONS

### 1. Challenges in Implementing E-content for Quality Education:

**Unequal Access to Technology:** Disparities in access to digital devices and the internet among students can hinder the effective utilization of E-content.

**Limited Digital Literacy:** Insufficient training and familiarity with digital tools among educators and students may impede the successful integration of E-content.

**Content Quality Assurance:** Ensuring the quality, relevance, and alignment of E-content with educational standards can be challenging.

**Cost Constraints:** Financial limitations for purchasing digital devices, software, and high-quality E-content pose significant obstacles.

### 2. Strategies to Overcome these Challenges:

**Digital Inclusion Initiatives:** Implement initiatives to provide equal access to technology, ensuring that all

students have access to digital devices and reliable internet connections.

**Comprehensive Digital Literacy Programs:** Develop and implement training programs for educators and students to enhance digital literacy skills, promoting the effective use of E-content.

**Quality Assurance Protocols:** Establish robust quality assurance measures for E-content, involving peer reviews, standardized frameworks, and continuous feedback loops to maintain high standards.

**Cost-Effective Solutions:** Explore cost-effective alternatives, such as open-source E-content platforms, collaborative partnerships, and initiatives to subsidize digital devices for economically disadvantaged students.

These challenges with proactive strategies, the implementation of E-content can be optimized, fostering quality education and mitigating disparities in access and digital literacy.

## CONCLUSION

The study has exposed major insights highlighting the central role of E-content in education. The importance of these findings is evident in the considerable positive influence that E-content exerts on the improvement of educational quality. The examination has illuminated the ways in which electronic resources positively affect learning outcomes, accessibility, and adaptability. Furthermore, when considering the wider ramifications of this research, it implies a transformative potential in guiding future educational strategies. The endorsement of E-content not only meets current educational requirements but also establishes the groundwork for a more dynamic and inclusive educational environment, promoting innovation and preparing learners for the challenges of the digital age.

## REFERENCES

1. Ahmad Tasnim Siddiqui, A. T., and Dr. Masud, M., (2012), "An E-learning System for Quality Education", IJCSI International Journal of Computer Science Issues, Vol. 9, Issue 4, No 1, ISSN (Online): 1694-0814 Retrieved from: [www.IJCSI.org](http://www.IJCSI.org).
2. Arun, A. and Dr. G. Singaravelu, (2019), "E-Content Development: future and provocation", JASC: Journal

- of Applied Science and Computations, Volume VI, Issue I, ISSN NO: 1076-5131, Retrieved from: <https://www.researchgate.net>
- 3 Dhavale, S. M. and et. al., (2014), "Development of E-Content for Effective Teaching and Learning", Retrieved from: <https://www.researchgate.net/publication/354144444>, ISBN: 978-93-5174-783-3, page no. 362-365
  4. Dr. Mishra, U., Dr. Patel, S. and Doshi, K., (2017), "E- Content: An Effective Tool for Teaching and Learning in A Contemporary Education System", International Journal of Advance Research and Innovative Ideas in Education (IJARIIE), Vol-2 Issue-1, ISSN(O)-2395-4396, Retrieved from: <https://www.researchgate.net/publication/337906834>.
  5. Guile, D. (2002). "Learning through „e-Resources: The Experience of SMEs. Vocational Training", School of Lifelong Education and International Development. Institute of Education. University of London, Retrieved from: <https://www.cedefop.europa.eu>, No. 27, pp. 30-46.
  6. Haleem, A. and et. al., (2022), "Understanding the role of digital technologies in education: A review" Sustainable Operations and Computers, Volume 3, Pages 275-285, Retrieved from: <https://doi.org/10.1016/j.susoc.2022.05.004>.
  7. Rukmani, V. and Dr. Gowrishankar, R., (2017), "Concept of E-Content Learning Environment in Higher Education: A Study" Vol-6, Issue-5, International Multidisciplinary E-Journal, ISSN:2277-4262, SJIF: 5.744. pg.106- 110. Retrieved from: <http://www.shreeprakashan.com>.

# Restructuring the Syllabus with the help of Fifth Industrial Revolution through the Holistic Education

**Seema L. Kadam**

Research Student  
Department of Education  
Shivaji University  
Kolhapur, Maharashtra  
✉ seema26kadam@gmail.com

**Pratibha S. Patankar**

Prof & Head  
Department of Education  
Shivaji University  
Kolhapur, Maharashtra  
✉ paratibhaspatankar@gmail.com

## ABSTRACT

This research paper explores how to update school curricula for the Fifth Industrial Revolution, focusing on a well-rounded approach called holistic education. The examination considers the influence of new technologies and emphasizes the necessity of reassessing traditional teaching methods. Through a review of existing literature and the application of a systematic methodology, the study identifies key areas for modification, giving weight to holistic education principles and the integration of advanced technologies. The results indicate that these adjustments have the potential to enhance learning, facilitate student adaptation to new technology, and contribute to their overall development. The paper also addresses challenges and proposes strategies for overcoming them. Looking ahead, the study envisions a sustained impact on education as new technologies are continually incorporated, and holistic education practices are refined. In conclusion, this research advocates for a paradigm shift in curriculum design to better align with the requirements of the Fifth Industrial Revolution, fostering both academic and personal growth.

Modify The curriculum with a holistic education approach during the Fifth Industrial Revolution is vital to synchronize education with technological progress. This endeavour seeks to empower students with a broad range of skills, nurturing adaptability and innovation crucial for navigating the swiftly changing digital environment.

## Objectives

1. To define the effects of the Fifth Industrial Revolution on education.
2. To explore the necessity of restructuring syllabi using the Fifth Industrial Revolution within a framework of holistic education.
3. To identify the Holistic Education Principles.
4. To search the methods for incorporating holistic education into update syllabi.

**KEYWORDS** : *Restructuring the Syllabus, Fifth industrial revolution (5IR), Holistic education.*

## INTRODUCTION

This paper is centred on the revolutionary influence of the Fifth Industrial Revolution (5IR), characterized by remarkable technological convergence. The impact of this era, fuelled by advancements such as AI and IoT (Internet of Things), transcends industrial domains to shape entire societies. Acknowledging the limitations of conventional education within this context, the investigation delves into the necessity to

overhaul educational frameworks. The objective is to comprehend and tackle the interdisciplinary and dynamic requirements of the 5IR, guaranteeing that curricula are in harmony with the changing demands of a digitally oriented world.

Restructuring the curriculum in response to technological advancements is very important for various reasons:

1. Alignment with Industry Needs: Ensuring educational content remains pertinent to swiftly

- changing industry demands, equipping students with skills necessary for emerging job markets.
2. Preparation for Future Careers: Equipping students with current technical skills, enhancing their employability and readiness for the technological landscape of their prospective careers.
  3. Technological Literacy: Cultivating technological literacy among students, empowering them to effectively navigate and utilize advanced technologies in personal and professional contexts.
  4. Encouraging Innovation and Creativity: Creating an environment that fosters innovation and creativity by integrating cutting-edge technologies into the curriculum, preparing students to think critically and solve intricate problems.
  5. Global Competitiveness: Elevating the global competitiveness of educational institutions and graduates by staying at the forefront of technological advancements, attracting students and collaborations globally.
  6. Developing Adaptability and Resilience: Instilling a mindset of adaptability and resilience in students, fostering a comfort with continuous learning and readiness to navigate technological changes in their careers.
  7. Addressing Workforce Skill Gaps: Allowing educational institutions to identify and bridge skill gaps in the workforce by tailoring the curriculum to meet evolving needs due to technological advancements.
  8. Integration of Emerging Technologies: Facilitating the integration of emerging technologies like artificial intelligence, blockchain, and the Internet of Things into the educational experience, providing practical skills and hands-on experience.
  9. Enhancing Learning Experiences: Offering students more engaging and dynamic learning experiences through the utilization of interactive technologies, simulations, and virtual platforms, improving overall comprehension and knowledge retention.
  10. Ethical Considerations and Responsible Use: Incorporating ethical considerations and responsible technology use into the curriculum, preparing students to navigate ethical challenges associated with advanced technologies in various fields.
  11. Promoting Lifelong Learning: Cultivating a culture of lifelong learning by emphasizing the importance of staying updated with technological advancements, fostering a commitment to continuous self-improvement.
- Restructuring the syllabus in response to technological advancements is vital to ensure educational relevance, prepare students for the evolving demands of industries, and foster a culture of innovation, adaptability, and ethical responsibility in the digital age.

### THE IMPORTANCE OF HOLISTIC EDUCATION IN FOSTERING COMPREHENSIVE DEVELOPMENT

Holistic education is essential for comprehensive development as it addresses various aspects of an individual's growth. It goes beyond intellectual advancement, encompassing the development of emotional intelligence, social skills, and physical well-being. Through the promotion of cultural awareness, encouragement of a passion for learning, and the instillation of ethical values, holistic education provides individuals with the essential skills for success in personal and professional life. This educational approach acknowledges the significance of resilience, creativity, and a lifelong learning mindset, preparing individuals to navigate challenges, make meaningful contributions to society, and lead fulfilling lives. In essence, holistic education guarantees a balanced and well-rounded development that extends beyond academic accomplishments, embracing the diverse dimensions of human potential.

#### Review of related research

1. Seemann, K., (2003), "Basic Principles in Holistic Technology Education", Journal of Technology Education
2. Seemann, K. W., & Talbot, R. (1995). Technacy: Towards a holistic understanding of technology

teaching and learning among Aboriginal Australians. Prospects.

3. Beno, M., (2019), “The Implications of the Industrial Revolutions for Higher Education”.
4. Santhi, A. R. and Muthuswamy, P., (2023), “Industry 5.0 or industry 4.0S? Introduction to industry 4.0 and a peek into the prospective industry 5.0 technologies.
5. Loose, C. Loose, and Jagielo-Manion, R., (2023), “Implementation of Personalized Learning and Technology Integration in the Fifth Industrial Revolution”.

**Conclusion**

The Fifth Industrial Revolution (5IR) is characterized by the intersection of revolutionary technologies. Artificial Intelligence (AI), Internet of Things (IoT), blockchain, robotics, biotechnology, quantum computing, 3D printing, augmented/virtual reality, 5G, and renewable energy solutions collectively transform industries. This harmonious integration represents a paradigm shift, significantly influencing our approaches to work, communication, and the sustainable progression of society.

**OBJECTIVES**

1. To define the effects of the Fifth Industrial Revolution on education.
2. To explore the necessity of restructuring syllabi using the Fifth Industrial Revolution within a framework of holistic education.
3. To identify the Holistic Education Principles.

4. To search the methods for incorporating holistic education into update syllabi.

**RESEARCH METHODOLOGY**

This research paper uses information from books, articles, and the internet. The analysis technique applied is content analysis.

The effects of the fifth industrial revolution on education.

The Fifth Industrial Revolution (5IR) is transforming education through the integration of advanced technologies, a focus on digital skills, and the promotion of personalized and interdisciplinary learning. Global connectivity is being fostered, with an accelerated adoption of remote and online learning. The development of AI-driven personalized tutoring is shaping the educational landscape, aligning it with the changing job market. In the 5IR era, education places a strong emphasis on continuous learning, ethical considerations in technology usage, and the development of a mindset geared towards innovation and entrepreneurship. Additionally, the integration of augmented and virtual reality experiences, coupled with a focus on green and sustainable practices, is becoming intrinsic to modern education.

**CONCEPTS OF SYLLABUS RESTRUCTURING IN THE CONTEXT OF THE 5IR**

Revamping the syllabus within the context of the Fifth Industrial Revolution (5IR) entails integrating fundamental concepts and principles that resonate with the transformative nature of this era. Key elements for syllabus restructuring in the 5IR include:

Essential Concepts/ Key Elements for Syllabus Restructuring in the 5IR		
1.	Encouraging Interdisciplinary Learning:	Promoting interdisciplinary approaches that integrate knowledge from diverse fields, recognizing the interconnectedness of 5IR technologies.
2.	Technology Integration in the Curriculum:	Incorporating technology throughout the curriculum, with a focus on artificial intelligence, blockchain, Internet of Things, and other 5IR technologies to equip students with essential digital skills.
3.	Project-Based Learning:	Prioritizing project-based learning to simulate real-world scenarios, fostering problem-solving, collaboration, and innovation – vital skills in 5IR industries.
4.	Critical Thinking and Creativity:	Giving precedence to critical thinking and creativity to prepare students for the dynamic challenges presented by technological advancements in the 5IR.



5.	Promoting Global Citizenship and Cultural Competence:	Cultivating global citizenship and cultural competence by infusing global perspectives, encouraging collaboration on international projects, and fostering an understanding of diverse cultures.
6.	Ethics and Responsible Technology Use:	Infusing ethical considerations related to technology use, data privacy, and responsible innovation, ensuring students are equipped to navigate the ethical challenges of the 5IR.
7.	Cultivating a Lifelong Learning Mindset:	Cultivating a mindset of lifelong learning by underscoring the importance of adaptability and continuous skill development in response to the rapid changes' characteristic of the 5IR.
8.	Incorporating Soft Skills Development:	Integrating soft skills development, including communication, emotional intelligence, and teamwork, recognizing their significance in the collaborative and diverse environments prevalent in the 5IR.
9.	Identifying Industry-Relevant Skill Development:	Identifying and incorporating industry-relevant skills needed for the 5IR job market, such as data analysis, cybersecurity, digital literacy, and proficiency with emerging technologies.
10.	Designing a Flexible and Adaptive Curriculum:	Designing a flexible and adaptive curriculum that can promptly respond to technological advancements, ensuring students acquire the most relevant and up-to-date skills.
11.	Fostering Innovation and Entrepreneurship:	Fostering an entrepreneurial mindset by integrating innovation and entrepreneurship concepts, encouraging students to create and adapt to new technologies rather than passively consuming them.
12.	Emphasizing Real-world Application:	Emphasizing the practical application of knowledge through internships, industry partnerships, and real-world projects, providing students with hands-on experience and bridging the gap between theory and practice.
13.	Implementing Continuous Feedback and Evaluation:	Implementing continuous feedback mechanisms and dynamic evaluation methods to assess student progress and adjust the curriculum based on emerging trends and industry needs.
14.	Integrating Environmental and Social Considerations:	Integrating environmental and social considerations into the curriculum, emphasizing sustainable practices and the societal impacts of technological advancements in the 5IR.

This comprehensive approach to syllabus restructuring aligns education with the demands of the 5IR, ensuring students are equipped not only with technical proficiency but also with the holistic skills and mindset required to thrive in a digitally driven and rapidly evolving world.

Restructuring curricula within the context of holistic education becomes imperative in light of the technological changes brought about by the Fifth Industrial Revolution. This guarantees adaptation to changing job demands, promotes interdisciplinary learning, emphasizes the practical use of knowledge, cultivates crucial life skills, and nurtures a sense of global citizenship. The objective is to ready students for a dynamic future by seamlessly incorporating both theoretical and practical dimensions of education.

"In 5.0, we will build upon the lessons of 4.0, refining and tailoring them to better suit the needs of a post-COVID and climate-affected world. The transformation of 4.0 systems for this new era will be a human-centric endeavour, leveraging the positive aspects of automation while discarding any detrimental elements."  
 - <https://www.uts.edu.au>

**The Holistic Education Principles.**

John Miller delineated holistic education as a philosophy anchored in three fundamental principles:

1. Connection: This involves integrating school subjects, establishing community links, nurturing students' connection with the Earth, and encouraging inner self-discovery.
2. Inclusion: This principle pertains to incorporating

students of diverse races and abilities, providing varied educational approaches to accommodate differences in learning styles.

3. Balance: Emphasizing equilibrium between complementary energies, such as individual and group learning, analytic and intuitive thinking, content and process, and learning and assessment.

### BASIC PRINCIPLES OF HOLISTIC EDUCATION

1. Educating for Human Development: The primary goal is to foster the inherent possibilities of human development, emphasizing strengthening connections to self, family, community, the global community, the planet, and the cosmos.
2. Honoring Students as Individuals: Acknowledging the uniqueness, creativity, and specific needs of each learner, promoting tolerance, respect, and appreciation for human diversity.
3. The Central Role of Experience: Viewing education as primarily experiential, portraying learning as an active, multisensory engagement between individuals and the world, nurturing natural, healthy growth.
4. Holistic Approach: Emphasizing "wholeness" at the core, perceiving each academic discipline as offering a distinct perspective on the integrated phenomenon of life, celebrating diverse views of reality.
5. New Role of Educators: Advocating for educators as facilitators of learning, emphasizing the organic and natural learning process, with teachers having autonomy to tailor learning environments.
6. Empowering Freedom of Choice: Highlighting the importance of authentic choices for students and parents throughout the learning process, emphasizing freedom of inquiry, expression, and personal growth.
7. Educating for a Participatory Democracy: Proposing that education should be grounded in democratic values, empowering all citizens to participate meaningfully in community and global affairs.

8. Educating for Global Citizenship: Regarding each individual as a global citizen, promoting an appreciation for the diversity of human experience and understanding of various cultures in the emerging global community.
9. Educating for Earth Literacy: Emphasizing the importance of education rooted in reverence for life in all forms, fostering a nurturing relationship between humans and the natural world.
10. Spirituality and Education: Recognizing all people as spiritual beings expressing individuality through talents, abilities, intuition, and intelligence, acknowledging spiritual development and a deep connection to self and others.

These principles, derived from "Education 2000: A Holistic Perspective," signify a holistic approach that transcends conventional boundaries, acknowledging the interconnectedness of various dimensions of human experience and development. (The statement, entitled "Education 2000: A Holistic Perspective," defined the central principles of Holistic Education (Flake2000, Nava2001, Schreiner2005).

### METHODS FOR INCORPORATING HOLISTIC EDUCATION INTO UPDATE SYLLABI

1. Interdisciplinary Learning Modules: Design modules that integrate various subjects to provide students with a holistic perspective, emphasizing the interconnectedness of knowledge.
2. Experiential Learning Opportunities: Include hands-on projects, internships, and field trips to offer practical experiences beyond traditional classroom settings, promoting holistic understanding.
3. Inclusion of Social and Emotional Learning (SEL): Embed SEL components to develop emotional intelligence and interpersonal skills, fostering a well-rounded approach to personal growth.
4. Personalized Learning Paths: Allow students to choose projects aligned with their interests, promoting individualized learning and addressing diverse needs.
5. Community Engagement Projects: Introduce

projects that connect students with their local community, encouraging collaboration and a sense of social responsibility.

6. **Mindfulness Practices:** Integrate mindfulness exercises to enhance focus, mental well-being, and the mind-body connection in the learning process.
7. **Cultural Diversity Integration:** Infuse the syllabus with diverse content to expose students to various cultures, fostering a global perspective and appreciation for diversity.
8. **Project-Based Assessments:** Implement assessments that require critical thinking and collaboration, aligning with real-world scenarios and enhancing holistic understanding.
9. **Technology Integration:** Leverage technology for interactive and engaging learning experiences, incorporating virtual reality and online simulations.
10. **Incorporate Environmental Awareness:** Introduce topics related to environmental sustainability to instill a sense of responsibility for the planet among students.
11. **Physical Health and Wellness Programs:** Include modules on nutrition, physical activity, and overall well-being to promote a holistic approach to health education.
12. **Encourage Critical Reflection:** Build opportunities for students to reflect on their learning experiences, personal growth, and the practical application of knowledge.
13. **Holistic Assessment Methods:** Revise assessment methods to include a mix of traditional exams, project assessments, presentations, and reflective journals for a comprehensive evaluation.
14. **Teacher Training and Professional Development:** Provide training for educators to familiarize them with holistic education principles, ensuring effective implementation in the classroom.
15. **Promote Lifelong Learning:** Emphasize the value of continuous learning beyond the classroom, encouraging students to adopt a mindset of lifelong learning and self-improvement.

## RESTRUCTURING SYLLABUS

- A. **Curriculum Integration:** Revise the curriculum to encompass interdisciplinary learning, global perspectives, and ethical considerations, aligning with the evolving requirements of the Fifth Industrial Revolution.
- B. **Holistic Education Approach:** Infuse holistic education principles, emphasizing social and emotional learning, wellness, and student-centric methodologies to deliver a well-rounded educational experience.
- C. **Technology Adoption:** Integrate technologies from the Fifth Industrial Revolution, such as AI and IoT (Internet of Things), into instructional strategies to cultivate inventive learning environments and equip students for a technology-centric future.

The syllabus restructuring initiative involves integrating interdisciplinary learning, holistic education principles, and cutting-edge technologies from the Fifth Industrial Revolution. The goal is to provide students with a well-rounded, innovative educational experience, preparing them for the evolving demands of a technology-centric future.

## CONCLUSION

The research promotes the need to restructure syllabi to align with the Fifth Industrial Revolution (5IR) through the incorporation of holistic education principles. The essential components encompass curriculum integration, a holistic approach that highlights social and emotional learning, and the integration of 5IR technologies. The study underscores the significance of tackling challenges, advocating for lifelong learning, and cultivating a comprehensive educational experience to ensure holistic student development.

## REFERENCES

1. Seemann, K., (2003), "Basic Principles in Holistic Technology Education", *Journal of Technology Education* Vol. 14 No. 2, pages.28-39, Retrieved from: <https://doi.org/10.21061/jte.v14i2.a.3>. <https://scholar.lib.vt.edu/ejournals>.
2. Seemann, K. W., & Talbot, R. (1995). *Technacy: Towards a holistic understanding of technology*

- teaching and learning among Aboriginal Australians. Prospects, Vol. 25 No. 4,
3. Beno, M., (2019), "The Implications of the Industrial Revolutions for Higher Education", Retrieved from: <https://www.researchgate.net/publication/335442210>.
  4. Santhi, A. R. and Muthuswamy, P., (2023), "Industry 5.0 or industry 4.0S? Introduction to industry 4.0 and a peek into the prospective industry 5.0 technologies", International Journal on Interactive Design and Manufacturing (IJIDeM,) 17:947–979 Retrieved from: <https://doi.org/10.1007/s12008-023-01217-8>.
  5. Loose, C. Loose, and Jagielo-Manion, R., (2023), "Implementation of Personalized Learning and Technology Integration in the Fifth Industrial Revolution", Journal on Empowering Teaching Excellence, Retrieved from: <https://uen.pressbooks.pub>.
  6. Sailer, M., Schultz-Pernice, F., & Fischer, F. (2021). "Contextual facilitators for learning activities involving technology in higher education: The Cb-model. Computers in Human Behaviour," 121, 1-13. <https://doi.org/10.1016/j.chb.2021.106794>





## D.Y. PATIL COLLEGE OF ENGINEERING SALOKHENAGAR, KOLHAPUR

Approved By AICTE, New Delhi  
Recognized By Govt. of Maharashtra  
Affiliated to Shivaji University, Kolhapur



## Why DYP SALOKHENAGAR ?

- Huge Eco friendly clean campus located in the heart of the city.
- Highly Qualified and Experienced teaching faculty.
- Modern and fully equipped laboratories.
- Strong tie-up with most of the industries in Western Maharashtra.
- 100% Placement for eligible candidates.
- 3 Start Ups by our final year students through Kolhapur Incubation Center.

### RESEARCH & LEARNING CENTERS/LAB

IOT Lab



BOT Lab



KIC  
(Kolhapur Incubation Center.)



CADSYS Lab

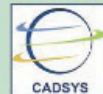

TIC  
(Tejas Innovation Center)



SDC  
(Skill Development Centre)



**338+**

Job Offers  
AY 2021-22

**204+**

Total Placement for  
AY 2021-22

**9.7 Lakh**

Highest Package

**4.5 Lakh**

Average Package

**3**

Start Ups  
By our final  
year students

**267+**

Internships for SY &  
TY students (paid & unpaid)

### INDUSTRY AFFILIATIONS/MOUs

- Automation Anywhere, USA
- NASSCOM
- Global Talent Trac (GTT)
- Aspiring Minds.
- PMKVY

### FACILITIES

- GATE Tutor software and hands-on training available for GATE Exam.
- Special Counseling of students through Mentoring Cell.
- Entrepreneurship cell, Sports cell & Competitive Exam cell.
- "Army 100 Program" a free skill development program for Toppers.
- All government scholarships are available.





Dr. D. Y. Patil Pratishthan's  
College of Engineering, Salokhenagar, Kolhapur, Maharashtra.

### Vision

- To strive and become center of excellence in under graduate engineering education & become a preferred institute of higher education.

### Mission

- To nurture a culture of excellence in teaching & learning with active involvement of stakeholders
- To provide quality technical education with focus on fundamentals and hence become a preferred educational institute in this region
- To encourage students participation in academics, co curricular & extracurricular activities for their overall personality development and emerge as innovators, leaders & entrepreneurs
- To promote sustainable practices with ethical values

### Main Features

- Virtual Labs (IIT-Bombay ) Nodal Centre Since 2022
- Well Qualified, Experienced Staff & Dedicated Faculty
- Reputed Professional, Outcome Based Education (OBE) Disciplined work culture for quality education
- Good transport facility
- MoU's with leading industries
- 40+ years of educational legacy
- Location of institute is in the heart of Kolhapur city
- Expert guest lectures, industrial tours, workshops for right aptitude development of students
- Digital library, Book bank scheme, journals, e-learning materials
- All Government Scholarships Available to Students
- Microsoft Certified Training for faculty & students
- Well Equipped Advanced Labs with high end PC's
- 24 hour Wi-Fi and Internet connected Campus
- Free Guidance & Training for GATE UPSC, MPSC, NASA / ISRO & other competitive examination
- Sports, Cultural and Gymnasium Facility for Students (Indoor & Outdoor)
- Extra Curriculum Activities, Content Beyond Syllabus
- PTC Certified Training
- Free Training for AUTOCAD, PRO-E, CNC, ORACLE
- Industrial visits in each semester
- Mentorship system to monitor students program
- KIC & Tejas Incubation centers in campus
- State of art infrastructure with well elaborated illuminated Classrooms & laboratory facilities



PUBLISHED BY  
**INDIAN SOCIETY FOR TECHNICAL EDUCATION**  
Near Katwaria Sarai, Shaheed Jeet Singh Marg,  
New Delhi - 110 016

Printed at: Compuprint, Flat C, Aristo, 9, Second Street, Gopalapuram, Chennai 600 086.  
Phone : +91 44 2811 6768 • www.compuprint.in